

NORTON

# DIAMOND AND cBN SUPERABRASIVES

EFFECTIVE 2014

STANDARD PRODUCTS CATALOG



# TABLE OF CONTENTS

## TECHNICAL INFORMATION

PSP – Process Solutions Program	<b>3</b>
ANSI Wheel Shape Identification System	<b>6</b>
Wheel Shape Index	<b>7</b>
Product Identification System	<b>9</b>
Competitive Cross Reference	<b>11</b>
Mounting, Truing and Dressing Guide	<b>62</b>
Tech Tips	<b>138</b>
Troubleshooting Guide	<b>138</b>
Material Hardness Scale	<b>138</b>
Decimal and Metric Equivalents of Fractions	<b>139</b>
Expected Surface Finish by Grit Size	<b>139</b>
Recommended Wheel Speeds	<b>139</b>
RPM/SFPM Conversion Table	<b>140</b>
Safety PPE and Safe Operating Practices	<b>141</b>

## NORTON STOCK PRODUCTS

Wheel Shape Index	<b>7</b>
General Information	<b>12</b>
How to Select Stock Diamond & cBN Wheels	<b>13</b>
Starting Recommendation Guide	<b>15</b>
Norton Stock Products	<b>17</b>
B105 Diamond Wheels	<b>21</b>
Aztec III cBN Wheels	<b>22</b>
Aztec .007 cBN Wheels	<b>22</b>

## NORTON B99 EXPRESS MADE-TO-ORDER RESIN WHEELS

Wheel Shape Index	<b>7</b>
General Information	<b>25</b>
How to Select B99 Express Products	<b>26</b>
B99 Express Made-To-Order Diamond & cBN Resin Products	<b>28</b>

## NORTON CNC WHEELS

Wheel Shape Index	<b>7</b>
Product Identification System	<b>9</b>
General Information	<b>54</b>
Diamond Wheels for CNC Machines	<b>55</b>
cBN Wheels for CNC Machines	<b>57</b>
CNC Express Made-To-Order Wheels	<b>59</b>

## NORTON OFF-LINE TRUING WHEELS

Conventional Truing Wheels	<b>60</b>
Micro Dressing Wheel	<b>60</b>

## NORTON BRAKE-CONTROLLED TRUING DEVICES

Brake-Controlled Truing Devices	<b>61</b>
Mounting, Truing, and Dressing Guide	<b>62</b>

## NORTON DRESSING STICKS

Norton Dressing Sticks	<b>63</b>
------------------------	-----------

## NORTON ROTARY DIAMOND DRESSING TOOLS

General Information	<b>65</b>
Dressing Spindles	<b>65</b>
Form Rolls (Reverse Plated and Infiltrated)	<b>66</b>
Dressing Discs (infiltrated, BPR and IDW)	<b>68</b>

## NORTON STATIONARY DIAMOND DRESSING TOOLS

General Information	<b>71-74, 109</b>
Single Point Tools	<b>75</b>
Toolroom Tools	<b>82</b>
Multi-Point (Grit) Tools	<b>85</b>
Blade Tools	<b>93</b>
Form Tools	<b>96</b>
Cluster Tools	<b>103</b>
Accessories	<b>104</b>
Tool Recommendations by Machine Type	<b>105</b>

## NORTON/WINTER FLIESEN STATIONARY DIAMOND DRESSING TOOLS

General Information	<b>111</b>
Furioso Plate and Shank Tools	<b>114</b>
Fliesen Plates	<b>116</b>
Fliesen Shank Tools	<b>118</b>
Triangle Insert Dressing Tools	<b>119</b>
Diamond Truing Pad	<b>119</b>
Tools by Machine Type Index	<b>120</b>
Competitive Cross Reference	<b>123</b>

## NORTON ELECTROPLATED TOOLS AND WHEELS

General Information	<b>125</b>
Diamond and cBN Mounted Points and Mandrels	<b>127</b>
Diamond Tapered Hones for Drawing Dies	<b>130</b>
Diamond Micro Drills and Routers	<b>131</b>
Diamond and cBN Mounted Contour Tools	<b>132</b>
Diamond Wheels	<b>133</b>
Diamond Files	<b>133</b>
Diamond Drills	<b>135</b>
Diamond Saw Blades	<b>136</b>

## NORTON DIAMOND LAPPING COMPOUND

Water and Oil Soluble Compounds	<b>137</b>
---------------------------------	------------

## GENERAL INFORMATION

Placing an Order	<b>4</b>
Product Tiering	<b>4</b>
UPC # to Page Index	<b>142</b>

## NORTON TRADEMARKS

All trademarks used in these pages are trademarks of Saint-Gobain Abrasives, unless otherwise indicated.

Aztec®	Norton®	USB™
Furioso™	Norton Quantum™ (NQ)	U-Dex-It™
G-Force™	Norton SG®	Univel®
MSL®	Pacesetter®	Winter®
Mini-Dex™	Paradigm®	And Others
Multi-Cut™	Targa® (TG)	

**MAXIMIZING PRODUCTIVITY**



**Norton Stock Wheels**

250+ USA-made, ISO-certified stock diamond and cBN resin products available now.



**Norton B99 Express Made-to-Order Resin Line**

65,000+ made-to-order diamond and cBN resin products: 25 wheel shapes, with 2 week (and less!) lead-times for 12" and less diameter wheels (14" wheels and larger are available with standard lead-times).



**CNC Wheels**

Norton Paradigm, G-Force, Univel, Resin, CNC Express. Our line of CNC diamond and cBN wheels are pre-engineered to satisfy customer requirements from high production cutting tool manufacturing to precision reshaping.



**Norton and Fliesen Stationary Truing and Dressing Products**

For all your stationary truing and dressing needs: the market's broadest line of stationary diamond tools, brake controlled truing devices, and dressing sticks.



**Norton Electroplated Tools and Wheels**

Our extensive stock diamond and cBN electroplated offering (mounted points, drills, routers, contour tools, wheels, files, and saw blades) has been engineered to meet the diverse demands of traditional and emerging tool and die, ceramic, and composite applications.



**Norton Diamond Lapping Compound**

Oil and water soluble compounds for mirror finishes and close-tolerance performance.



**REDUCING COSTS**

On average, abrasives and cutting tools only account for about 3% of total manufacturing budgets. Norton superabrasive products optimized with Norton's proprietary PSP (process solutions program) helps to optimize your total cost and improve your productivity.

For information on how to achieve the greatest overall cost savings, see the example below or go to [www.nortonindustrial.com/psp.aspx](http://www.nortonindustrial.com/psp.aspx).

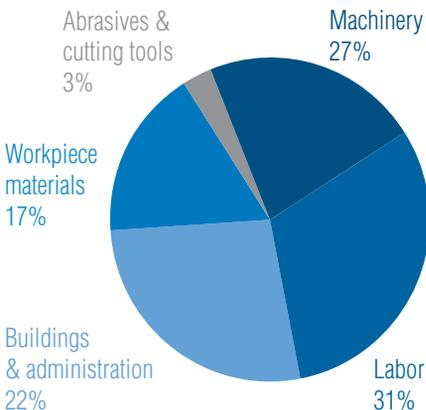

**Decreasing the price of abrasives**

A 30% price reduction will **only** reduce costs per part by **1%**.

**Increasing the life of abrasives**

Even a 50% increase in product life will **only** reduce costs per part by **1%**.

**Increase overall productivity through PSP**

With a 20% decrease in cycle time per part, there will be a **reduced total cost** per part of **more than 15%**.



## PLACING AN ORDER

To enable your authorized distributor to fill your order quickly and accurately, please be sure to include your billing and shipping address, purchase order number, and the following product information:

- **UPC Number**
- **The Wheel Shape** – see the “Wheel Shape Index”
- **Product Dimensions** – such as **Diameter x Thickness x Hole for a wheel, or Thickness x Width x Length for a dressing stick, etc.**
- **Complete Specification** – example: **ASD120-R100B99-1/8 (abrasive, grit, grade, concentration, bond, abrasive depth) for a wheel, or 38A220-HVBE for a dressing stick, or NS2M6 for a dressing tool, etc.**
- **Blueprint Number** – if available
- **Quantity Ordered**

## NORTON PRODUCT TIERING CONCEPT

Norton offers the industry's widest selection of products at three separate value levels to meet your exact grinding needs. Norton abrasives are classified in BEST (gold), BETTER (silver), and GOOD (black) performance/price tiers to help you choose the right product for your specific application every time.

To help you compare and contrast the performance and price levels within each Norton line, the product availability charts highlight the product tier level with a color-coded “tiering bar”.

Remember, premium Norton products – BEST and BETTER tiers – will always be the best overall value for your money. While initial unit cost is more, BEST and BETTER products will yield longer life and better performance, resulting in lowest total grinding cost.

### BEST

### BEST PERFORMANCE

- Represents products that are unmatched in the industry and provide the lowest total grinding cost for the application.
- In many cases, these products are proprietary and only available from Norton.

### BETTER

### PREMIUM PERFORMANCE

- Represents superior performing products for the user who requires a high level of productivity and low total abrasive cost.

### GOOD

### EXCELLENT PERFORMANCE, QUALITY AND VALUE

- Represents a value for the user who wants Norton quality products with consistent performance and very competitive prices.

## PRODUCT WARRANTY

WARRANTY – Saint-Gobain Abrasives Inc. (SGA) warrants the products in this catalog to be free from defects in material or workmanship for a period of one year from the date of purchase. SGA's sole obligation under this warranty shall be to repair or replace, at SGA's option, any product which is non-conforming provided any such product failure was not caused by a subsequent modification of the product, misuse or a failure to follow any applicable instructions for the product.

EXCEPT FOR THE FOREGOING, SGA EXPRESSLY DISCLAIMS ALL OTHER GUARANTIES AND/OR WARRANTIES, EXPRESS OR IMPLIED, INCLUDING THE WARRANTIES OF MERCHANTABILITY AND FITNESS FOR A PARTICULAR PURPOSE.

## LIABILITY LIMITATION

SGA'S LIABILITY FOR ANY LOSS OR DAMAGE ARISING OUT OF OR RESULTING FROM THE USE OF THE PRODUCT SHALL NOT EXCEED THE PURCHASE PRICE THEREOF, REGARDLESS OF WHETHER SUCH LIABILITY ARISES IN CONTRACT, TORT (INCLUDING WITHOUT LIMITATION NEGLIGENCE OR STRICT LIABILITY), OR OTHERWISE, AND IN NO EVENT SHALL SGA BE LIABLE FOR INDIRECT, SPECIAL, INCIDENTAL OR CONSEQUENTIAL DAMAGES OF ANY KIND. NO REPRESENTATIVE OF SGA, NOR ANY OF SGA'S DISTRIBUTORS OR DEALERS, IS AUTHORIZED TO MODIFY THIS WARRANTY OR ISSUE ANY WARRANTY REGARDING THE PRODUCTS IN THIS CATALOG.

## BREAKAGES/PERSONAL INJURY

In the event of on-machine breakage of Norton abrasive products, call your local Norton Distributor immediately. Whether involving personal injury or not, the abrasive user should leave the equipment and other evidence undisturbed until a Norton Sales Representative has been notified and conducts an investigation. Prompt action on the part of abrasive users, Distributors and Norton sales personnel is important to ensure swift determination of the breakage cause and to guard against recurrence.

For additional information, please review ANSI, OSHA and literature provided by the grinding wheel and machine manufacturer. You may also contact the Saint-Gobain Product Safety Department at **Telephone 508-795-2317** or **Fax 508-795-5120** or your Saint-Gobain Abrasives, Inc. representative with any safety related questions.



# ANSI WHEEL SHAPE IDENTIFICATION SYSTEM

The American Standard Code employs a series of numbers and letters to designate the shape of a diamond wheel. Its use involves four simple steps shown at right.

In this example, the complete wheel shape number would read:

**6A2C**

COURTESY OF ANSI

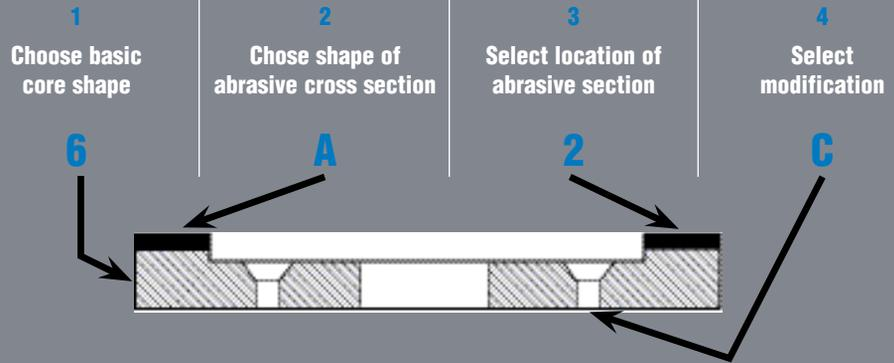

## 1. BASIC CORE SHAPES AND MARKS

1	2	3	4	6
9	11	12	14	15

## 2. ABRASIVE CROSS SECTIONS AND MARKS

A	AH	B	C	CH	D	DD	E	EE	F	FF	G	H
J	K	L	LL	M	P	Q	QQ	S	U	V	Y	

## 3. LOCATION OF ABRASIVE SECTION AND MARKS

1 - PERIPHERY	2 - SIDE	3 - BOTH SIDES	4 - INSIDE BEVEL OR ARC	5 - OUTSIDE BEVEL OR ARC	6 - PART OF PERIPHERY	7 - PART OF SIDE	8 - THROUGHOUT	9 - CORNER	10 - ANNULAR

## 4. POPULAR MODIFICATIONS AND MARKS

B - DRILL AND COUNTERBORE	C - DRILL AND COUNTERSINK	H - PLAIN HOLE	K - KEYWAY	M - HOLES PLAIN AND THREADED	T - THREADED HOLES	P - RELIEVED ONE SIDE
Q - ABRASIVE SECTION INSERTED	R - RELIEVED TWO SIDES	S - ABRASIVE SECTION SEGMENTED	SS - ABRASIVE SECTION SEGMENTED AND SLOTTED	V - ABRASIVE SECTION INVERTED	W - STEMMED	Y - ABRASIVE SECTION INSERTED AND INVERTED

# WHEEL SHAPE INDEX

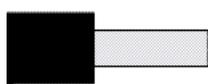
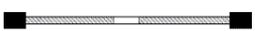
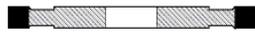
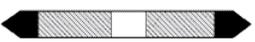
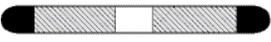
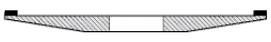
<b>ILLUSTRATION</b>  DIAMOND OR cBN MATERIAL	<b>WHEEL SHAPE</b>	<b>AVAILABILITY</b>		
		<b>NORTON STOCK WHEELS</b>	<b>NORTON B99 EXPRESS MADE-TO-ORDER RESIN WHEELS</b>	<b>CNC WHEELS: NORTON UNIVEL, NORTON G-FORCE NORTON/WINTER NORTON</b>
	<b>DW</b>	PAGE 17		
	<b>HH1</b>	PAGE 17		
	<b>HH2</b>	PAGE 17		
	<b>1A1</b>	PAGES 17 – 18	PAGE 28	PAGES 55, 57
	<b>1A1R</b>	PAGE 19	PAGE 29	
	<b>1A1RN</b>			PAGES 55, 57
	<b>1A8</b>		PAGE 29	
	<b>1B1</b>		PAGE 30	PAGES 55, 57
	<b>1E1</b>		PAGE 30	
	<b>1EE1</b>		PAGE 30	
	<b>1F1</b>		PAGE 31	
	<b>1FF1</b>		PAGE 31	
	<b>1V1</b>	PAGE 19	PAGE 32	PAGES 55 – 57
	<b>2A2T</b>		PAGE 33	
	<b>3A1</b>		PAGE 34	
	<b>4A2 &amp; 4A2P</b>	PAGE 20	PAGE 35	
	<b>4Y1</b>		PAGE 36	
	<b>6A2</b>		PAGE 37	PAGES 56, 57

# WHEEL SHAPE INDEX

<b>ILLUSTRATION</b> ■ DIAMOND OR cBN MATERIAL	<b>WHEEL SHAPE</b>	<b>AVAILABILITY</b>		
		<b>NORTON STOCK</b>	<b>NORTON B99 EXPRESS MTO RESIN</b>	<b>CNC WHEELS:                      NORTON UNIVEL                      NORTON G-FORCE                      NORTON/WINTER                      NORTON</b>
	<b>6A2C</b>	PAGE 20	PAGES 38 – 39	
	<b>6A2H</b>	PAGE 20		
	<b>6A9</b>		PAGE 40	
	<b>11A2</b>	PAGE 20	PAGE 41	PAGES 56, 58
	<b>11V5</b>			PAGES 56, 58
	<b>11V9</b>	PAGES 21 – 22	PAGES 42 – 44	PAGES 56, 58
	<b>12A2</b>	PAGE 23	PAGES 44 – 45	
	<b>12V9</b>	PAGE 23	PAGES 46 – 47	PAGES 56, 58
	<b>14A1</b>		PAGE 48	
	<b>14F1</b>			PAGE 63
	<b>15A2</b>		PAGE 49	
	<b>15V4</b>		PAGE 50	
	<b>15V9</b>	PAGE 23	PAGES 51 – 52	



**NORTON DIAMOND PRODUCT IDENTIFICATION SYSTEM / USAGE INFORMATION**

ASD 120 – R 75 B99 1/8

ABRASIVE TYPE	GRIT SIZE	GRADE	CONCENTRATION	BOND	ABRASIVE DEPTH
<b>ASD</b> <ul style="list-style-type: none"> <li>Used with B99 and B105 bonds</li> <li>Armored</li> <li>Durable</li> <li>Versatile</li> <li>Wet or dry</li> <li>Carbide/steel operations</li> </ul>	<ul style="list-style-type: none"> <li>100, 100S – Roughing</li> <li>120 – Roughing/cutting-off</li> <li>150 – Combined roughing and finishing</li> <li>180 – Improving finish</li> <li>220, 320 &amp; 400 – Finishing only</li> <li>10/20 mic</li> <li>6/12 mic</li> </ul>	<b>Resin Bond</b> R – Norton standard N – Free cutting <b>Metal Bond</b> N – Norton standard <b>Vitrified Bond</b> P – Norton standard R – Most durable	<b>50</b> <ul style="list-style-type: none"> <li>Most economical</li> <li>For broad area of contact</li> </ul> <b>75</b> <ul style="list-style-type: none"> <li>Norton standard</li> <li>Freer cutting than 100</li> <li>Dry grinding with ASD</li> </ul> <b>100</b> <ul style="list-style-type: none"> <li>Very durable</li> <li>For flood coolants</li> <li>Use with 220 grit or finer</li> <li>Use for cutting-off</li> </ul> <b>115</b> <ul style="list-style-type: none"> <li>For CNC grinding machines</li> </ul> <b>125</b> <ul style="list-style-type: none"> <li>Form holding</li> <li>For high volume, high pressure coolant, precision applications on high-speed tool steels</li> </ul>	<b>B99</b> <ul style="list-style-type: none"> <li>Resin bond</li> <li>Wet or dry</li> <li>Tool making; resharpening</li> </ul> <b>B105</b> <ul style="list-style-type: none"> <li>Premium resin bond</li> <li>Advanced heat-reducing bond</li> <li>Dry; reconditioning</li> </ul> <b>B610 and B80</b> <ul style="list-style-type: none"> <li>For CNC grinding machines</li> </ul> <b>M99</b> <ul style="list-style-type: none"> <li>Metal bond</li> <li>1A1R cut-off</li> <li>Glass and ceramics</li> </ul> <b>MSL</b> <ul style="list-style-type: none"> <li>Metal single layer</li> <li>Type 6A2C only</li> <li>Dry</li> <li>Offhand reconditioning/finishing carbide</li> </ul> <b>V99</b> <ul style="list-style-type: none"> <li>Vitrified bond</li> <li>Offhand finishing of carbide tools</li> <li>Plunge grinding</li> </ul>	1/16" 1/8" 1/4" 9/32" 3/8" 1/2" (New!) 3/4" Solid
<b>CD</b> <ul style="list-style-type: none"> <li>Used with B99 bond</li> </ul>					
<b>D</b> <ul style="list-style-type: none"> <li>Used with B99 bond</li> <li>Micron-sized diamond; finishing</li> </ul>					
<b>M3D</b> <ul style="list-style-type: none"> <li>Used with M99 bond</li> </ul>					
<b>M4D</b> <ul style="list-style-type: none"> <li>Used with M99 bond</li> <li>Armored</li> <li>Durable; for non-metallics</li> </ul>					
<b>RMD</b> <ul style="list-style-type: none"> <li>Used with V99 bond</li> </ul>					
<b>SD</b> <ul style="list-style-type: none"> <li>Used with B99 and V99 bonds</li> <li>Norton standard</li> <li>Wet or dry</li> <li>Free cutting</li> <li>Low horsepower (3/4 hp or less)</li> </ul>					

**NORTON CBN PRODUCT IDENTIFICATION SYSTEM / USAGE INFORMATION**

CB 120 – T B99 1/8

ABRASIVE TYPE	GRIT SIZE	GRADE	BOND	ABRASIVE DEPTH
<b>CB – cubic Boron Nitride</b> <ul style="list-style-type: none"> <li>Used with B99 bond</li> <li>Armored</li> <li>Wet or dry</li> </ul>	<ul style="list-style-type: none"> <li>100 – Roughing</li> <li>120 – Roughing/cutting-off</li> <li>150 – Combined roughing and finishing</li> <li>180 – Improving finish</li> <li>220, 320, 400 – For finishing only</li> </ul>	<b>Q</b> <ul style="list-style-type: none"> <li>Approx. 50 concentration</li> <li>Type 6A2</li> <li>Broad area of contact</li> </ul> <b>T</b> <ul style="list-style-type: none"> <li>Approx. 75 concentration</li> <li>Norton standard</li> <li>First choice</li> <li>Lower horsepower</li> <li>Broad area of contact</li> <li>Dry grinding</li> <li>Resharpening applications</li> </ul> <b>W</b> <ul style="list-style-type: none"> <li>Approx. 100 concentration</li> <li>Most durable</li> <li>High volume coolant</li> <li>Flute polishing</li> <li>Surface grinding</li> <li>Cylindrical grinding</li> </ul>	<b>B99</b> <ul style="list-style-type: none"> <li>Resin bond</li> <li>Wet or dry</li> </ul> <b>BXD3037 and WBB &amp; WBE</b> <ul style="list-style-type: none"> <li>For CNC grinding machines</li> </ul> <b>Aztec III</b> <ul style="list-style-type: none"> <li>Premium resin bond</li> <li>Dry</li> <li>Tool resharpening</li> </ul> <b>Aztec .007</b> <ul style="list-style-type: none"> <li>Premium resin bond</li> <li>Dry</li> <li>Increased feed rates</li> <li>Heavy stock removal</li> <li>Heavier cuts</li> </ul>	1/16" 1/8" 1/4" 1/2" (New!) Solid
<b>BAM &amp; BX – cubic Boron Nitride</b> <ul style="list-style-type: none"> <li>For CNC grinding machines</li> </ul>				

**WINTER DIAMOND PRODUCT IDENTIFICATION SYSTEM / USAGE INFORMATION**

D 220 – C 100 K+ 925 Y A

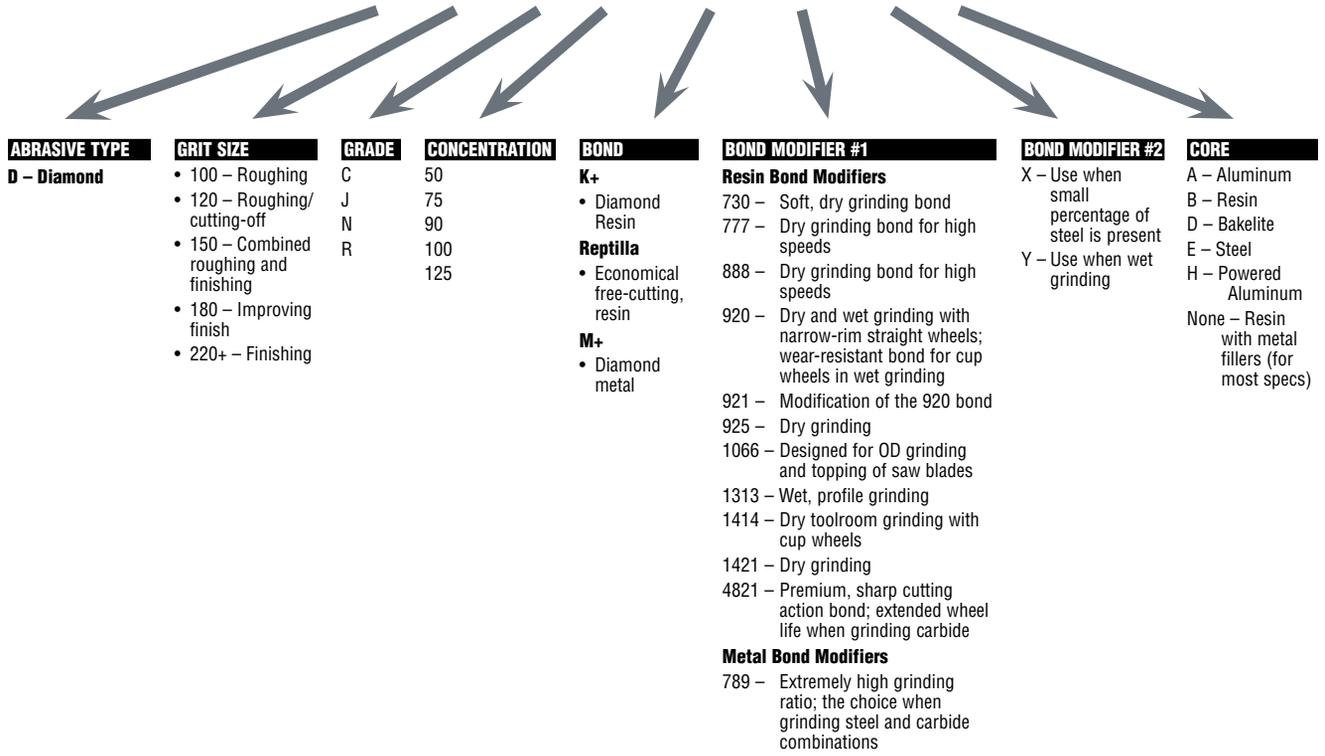

**WINTER CBN PRODUCT IDENTIFICATION SYSTEM / USAGE INFORMATION**

B 220 – V 240 KSS 920 Y A

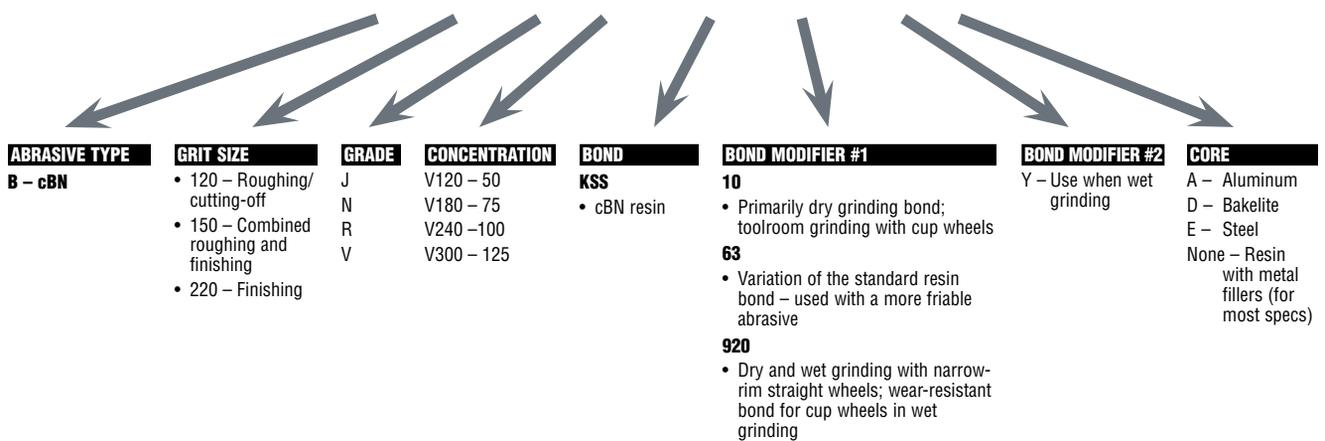

	NORTON										
	ABRASIVES				BONDS						
	RESIN DIAMOND ASD	RESIN DIAMOND SD	METAL DIAMOND M4D	RESIN/VITRIFIED cBN CB	RESIN DIAMOND B99/B99E	RESIN DIAMOND B105	METAL DIAMOND M99	VITRIFIED DIAMOND V99	RESIN cBN B99/B99E	RESIN cBN B99EF	RESIN cBN AZTEC
<b>3M / General Industrial Diamond / Diamond Productions, Inc</b>	CGD, ND	GD, D, MD		CB	PS			V		BC	
<b>Abrasive Technology</b>	SN	S		cBN	B		M		B		
<b>Accurate Diamond Tool</b>	NCD	D, MD		BN	B		M				
<b>Citco</b>	5SD, 6SD	SD	MD	CB	B43, B52		M		B26	C3	
<b>Engis</b>	NMD	D, MD		cBN, CB							
<b>Noritake</b>				CBC		BX4			BD/B38		BX4
<b>Radiac / US Diamond</b>	NCD, WD, 1WD, MDC	D, MD	MD4C	B, CB, BZ	B7Z, BB, B5, B56, BN		M, MF	V	BZ, BN		
<b>Regal Diamond</b>				B, BB	BJ						
<b>Superabrasives, Inc.</b>	MDN	D, MD		B					B82	B5	
<b>Tyrolit / Wickman / Bay State / Cincinnati</b>	SDM, XDL, XDN, D, 7D, CMD	SD, D, 6D, MD	1D	5B, 1BN, BN, BM	BD, BC, BX33, B52, B6	Amigo	MI, MSS, MB		B72, B56, BG, B7	BXU8	Amigo
<b>Wendt / Slip Naxos / Winterthur</b>	SDK			B, BXW					RN	RR	

	NORTON POLYIMIDE				NORTON/WINTER			
	ABRASIVES		BONDS		ABRASIVES		BONDS	
	DIAMOND AD	cBN BX	DIAMOND AND cBN UNIVEL	DIAMOND AND cBN G-FORCE	DIAMOND D	cBN B	RESIN DIAMOND K+888	RESIN cBN K+920
<b>3M / General Industrial Diamond / Diamond Productions, Inc</b>	D	CB	BP	BPP	CGD, ND	CB	PS	
<b>Abrasive Technology</b>					SN	cBN	B	B
<b>Accurate Diamond Tool</b>					NCD	BN	B	
<b>Citco</b>	SD	CB	P	C5	5SD	CB	B43, B52	B26
<b>Engis</b>					NMD	cBN, CB		
<b>Noritake</b>						CBC		BD/B38
<b>Radiac /</b>					NCD, WD, 1WD, MDC	B, CB, BZ	B7Z, BB, B5, B56, BN	BZ, BN
<b>Regal Diamond</b>						B, BB	BJ	
<b>Superabrasives, Inc.</b>					MDN	B		B82
<b>Tyrolit / Wickman / Bay State / Cincinnati</b>					SDM, XDL, XDN, D, 7D, CMD	5B, 1BN, BN, BM	BD, BC, BX33, B52, B6	B72, BG56, BG, B7
<b>Wendt / Slip Naxos / Winterthur</b>					SDK	B, BXW		RN

The “99” line of quality stock Diamond and cBN (cubic Boron Nitride) grinding products includes resin, vitrified, metal and MS� (metal single layer) bonds. Premium, high performance resin bond diamond and cBN wheels are also available.

## TYPICAL APPLICATIONS

### Norton B99 Diamond Wheels

- Sharpening cemented carbide cutting tools
- Cutting off carbide rod
- Grinding or cutting off non-ferrous materials such as ceramics or glass
- Surface grinding dies
- O.D. grinding spray coatings

### Norton B99 cBN Wheels

- Sharpening high-speed (M2, D2, T15, etc.) steel cutting tools
- Surface and ID grinding hardened steel die components
- Precision grinding steel parts Rc 50 or harder



## DIAMOND WHEELS

FEATURES	BENEFITS
■ High quality synthetic diamond	■ High material removal rates; longer wheel life versus conventional green silicon carbide wheels
■ Pre-engineered resin bond – B99	■ Free cutting; superior form holding; efficient wet or dry
■ Premium, heavy-duty resin bond – B105	■ Ideal for dry toolroom reconditioning applications
■ Metal bond – M99	■ Ideal for 1A1R cut-off applications and grinding glass or ceramic materials
■ MS� (metal single layer) diamond	■ Fast stock removal, cool cutting; excellent for dry offhand finishing of carbide tools; no wheel dressing required
■ Vitrified bond – V99	■ Most durable under high grinding forces; excellent for wet, offhand finishing of carbide tools

## cBN WHEELS

FEATURES	BENEFITS
■ cBN (cubic Boron Nitride) abrasive material is second in hardness to diamond	■ Easily cuts difficult-to-grind steel parts Rc 50 or harder
■ Pre-engineered resin bond – B99	■ Highly wear resistant and thermally stable
■ Premium Aztec III resin bond	■ Free cutting, superior form holding
■ Premium Aztec .007 resin bond	■ Most efficient for dry tool resharpening
	■ Most efficient for dry tool resharpening where heavy stock removal is desired

## TECHtip

- Truing makes the wheel concentric with the spindle.
- Dressing opens the wheel’s cutting face.
- Always true and dress diamond and cBN wheels prior to use.
- Diamond and cBN wheels with grit sizes 100 - 180 can be trued with a Brake Controlled Truing Device.
- Refer to the “Mounting, Truing and Dressing Guide” for more information.



It is the user’s responsibility to refer to and comply with ANSI B7.1

HOW TO SELECT NORTON STOCK DIAMOND WHEELS

SELECT

SHAPE		Use the “Wheel Shape Index” to determine shape and availability.
WHEEL DIMENSIONS	<b>D x T x H</b> <b>Select Diameter x Thickness x Hole from the availability tables.</b> Use blueprint numbers where available.	
ABRASIVE	<p><b>RESIN BOND WHEELS:</b></p> <p><b>ASD</b> <b>Armored diamond, durable.</b> Versatile: can be used wet or dry. Also should be used when carbide and steel are ground in the same operation.</p> <p><b>D</b> <b>Micron-sized diamond.</b> Used for finishing and polishing operations.</p> <p><b>SD</b> <b>Free cutting standard.</b> Used wet or dry; should be used on low horsepower (3/4 hp or less) machines.</p> <p><b>METAL BOND WHEELS:</b></p> <p><b>M4D</b> <b>Armored, durable standard.</b> A strong, blocky crystal designed for high performance on glass, ceramics, refractories and other non-metallics.</p> <p><b>VITRIFIED BOND WHEELS:</b></p> <p><b>RMD</b> <b>Medium strength.</b> Specifically designed for use with vitrified bonds.</p> <p><b>SD</b> <b>Free cutting standard.</b></p>	Select the abrasive based on horsepower, grinding wet or dry, and contact with steel.
GRIT SIZE	<p><b>100</b> <b>Roughing.</b> The most common grit size for roughing operations.</p> <p><b>120</b> <b>For roughing where 100 is too coarse.</b> Also for cut-off applications.</p> <p><b>150</b> <b>Medium stock removal plus good finish.</b> For combined roughing and finishing applications.</p> <p><b>180</b> <b>Medium stock removal plus good finish.</b> To improve finish.</p> <p><b>220</b> <b>Finishing</b></p> <p><b>320</b> <b>Finishing</b></p> <p><b>400</b> <b>Fine Finishing</b></p> <p><b>10/12 Mic</b> <b>Super Fine Finishing</b></p> <p><b>6/12 Mic</b> <b>Super Fine Finishing</b></p>	Select the abrasive grit size based on finish and material removal rate required.
GRADE	<p><b>RESIN BOND WHEELS:</b></p> <p><b>R</b> <b>Norton standard</b></p> <p><b>N</b> <b>Free cutting</b></p> <p><b>METAL BOND WHEELS:</b></p> <p><b>N</b> <b>Norton standard</b></p> <p><b>VITRIFIED BOND WHEELS:</b></p> <p><b>P</b> <b>Norton standard</b></p> <p><b>R</b> <b>Most durable</b></p>	The hardness of the wheel
CONCENTRATION	<p><b>50</b> <b>Most economical.</b> For broad area of contact grinding.</p> <p><b>75</b> <b>Norton standard.</b> Freer cutting than 100 and the most economical for dry grinding with ASD diamond.</p> <p><b>100</b> <b>Very durable.</b> Recommended under flood coolant conditions; for use with 220 grit or finer, when durability is required, and for cut-off applications.</p> <p><b>125</b> <b>Form holding.</b> Used in high-volume, high-pressure coolant, precision applications on high speed tool steels.</p>	Select the abrasive concentration based on grinding wet or dry, material removal rates and form holding requirements.
BOND	<p><b>RESIN BOND:</b></p> <p><b>B99</b> <b>Norton standard.</b> Versatile enough to be used wet or dry on most tool making or resharpening applications.</p> <p><b>B105</b> <b>Premium, heat-reducing bond.</b> For dry toolroom reconditioning applications.</p> <p><b>METAL BOND:</b></p> <p><b>M99</b> <b>Best suited for 1A1R cut-off applications</b> as well as grinding glass or ceramic materials.</p> <p><b>MSL</b> <b>Metal Single Layer.</b> Available in shape 6A2C for dry, offhand reconditioning of carbide tools.</p> <p><b>VITRIFIED BOND:</b></p> <p><b>V99</b> <b>Best for wet offhand finishing of carbide tools</b> as well as plunge grinding of carbide tools.</p>	Select the bond based on the material being ground and grinding application.
ABRASIVE DEPTH	<p>1/16</p> <p>1/8</p> <p>1/4</p> <p>9/32</p> <p>Solid</p>	Usable abrasive

HOW TO SELECT NORTON STOCK CBN WHEELS

SELECT

SHAPE			Use the “Wheel Shape Index” to determine shape and availability.
WHEEL DIMENSIONS	D x T x H	<b>Select Diameter x Thickness x Hole from the availability tables.</b> Use blueprint numbers where available.	
ABRASIVE	CB	<b>Norton standard coated cBN (cubic Boron Nitride).</b> Optimized for high performance in resin bond systems.	Select Norton cBN abrasive to grind hard tool steels such as A2, D2, T15, etc., and tough alloy steels.
GRIT SIZE	100 120 150	<b>100</b> Roughing. The most common grit size for roughing operations. <b>120</b> For roughing where 100 is too coarse. Also for cut-off applications. <b>150</b> Medium stock removal plus good finish. For combined roughing and finishing applications.	Select the grit size based on finish and material removal rate required.
GRADE	Q T W	Approximately 50 concentration. Used on wide area of contact applications. <b>Norton standard.</b> Approximately 75 concentration. T is the first choice for lower horsepower equipment or large area of contact between the wheel and the work piece. Ideal for resharpening applications with 11V9, 12A2, 4A2P, and 15V9 wheel shapes when dry grinding. <b>Most durable.</b> Approximately 100 concentration, W is recommended for high-volume coolant operations: flute grinding from solid, flute polishing, surface, and cylindrical grinding.	The hardness of the wheel
BOND	B99 Aztec III Aztec .007	<b>Norton standard.</b> Pre-engineered for optimal performance with cBN abrasive. Available in all shapes. <b>The Norton advanced heat-reducing, lubricating resin bond.</b> Used for dry grinding tool steels. <b>The Norton premium resin bond for increased feed rates,</b> high stock removal and heavier cuts – when dry grinding tool steels.	Select the bond depending on the type of grinding application.
ABRASIVE DEPTH	1/16 1/8 1/4 9/32 Solid		Usable abrasive

**NORTON OFFERS A COMPREHENSIVE STOCK PRODUCT SELECTION TO SERVICE MOST OF YOUR NEEDS – WITH THE FASTEST DELIVERY AND LOWEST PRICES. SEE THIS CATALOG SECTION FIRST:**

- Norton Stock B99 Products

**Can’t find the specification in the above section?**

Then refer to the Norton B99 Express Made-to-Order Resin Product section on pages 24 - 52 and the Norton CNC Wheel section on pages 53 - 59.

**If a product can not be found in the B99 Express offering:**

Contact your Norton sales representative or distributor for a custom-made product recommendation.

TECHtip

**DIAMOND GRINDS:**

In general, diamond is used to grind non-ferrous materials, because it reacts with iron.

- Cemented carbide
- Glass
- Ceramics
- Fiberglass
- Plastics
- Stone
- Abrasives
- Electronic components and materials

**cBN GRINDS:**

cBN is used to grind ferrous materials.

- High-speed tool steels
- Die steels
- Hardened carbon steels
- Alloy steels
- Aerospace alloys
- Hardened stainless steel
- Abrasion-resistant ferrous materials



It is the user’s responsibility to refer to and comply with ANSI B7.1

# SPECcheck

## DIAMOND WHEEL STARTING RECOMMENDATION GUIDE

APPLICATION OR COMMON MACHINE TYPE	COMMON WHEEL SIZE, TYPE & BLUEPRINT	APPLICATION VARIABLES	RECOMMENDED SPECIFICATION
<b>CARBIDE GRINDING – TOOLROOM PRODUCTION</b>			
Blanchard Grinding • Vertical Spindle Surface Grinding	10", 11", 16" & 18" diameters Type 2A2T	Wet – solid carbide • 1" or larger pieces – roughing • Small pieces Carbide & steel (combination)	SD100-R75B99E* ASD100-R75B99E* ASD100-R75B99E*
Hand • Burr Grinding	6" x 3/32" x 1-1/4" Type 1V1P V – 20° ME89562	Dry	ASDC320B-R125B99
Centerless (wet) • Throughfeed Grinding • Unison Dedtru Grinder	12", 14", 16", 18", & 20" diameters Type 1A1 7" x 1" x 1-1/4" Type 1A1	Roughing	ASD100-R75B99E* ASD150-R75B99E*
Cutting Off (wet)	6" x .035" x 1-1/4" Type 1A1R ME43572 10" x .050" x 1-1/4" Type 1A1R ME43565	• Most durable • Free cutting	ASD100S-R100B99 SD100-R75B99 SD120-R100B99
Cylindrical Grinding (wet)	10", 12", 14", 16" & 20" diameters Type 1A1	Wet, rough grinding of cemented carbides, hard (55 Rc+) plasma and ceramic spray coatings Wet, finish grinding of all carbides, plasma and ceramic spray coatings	ASD180-R100B99 ASD180-R75B99E* ASD150-R75B99 ASD120-R75B99 SD220-R100B99E*
Tool Sharpener Grinder (wet) • Bench Type	5" x 1" x 1-1/4" Type 6A2H ME27084 Rim Width (W) = 1-1/16	Tool sharpening	SD320-R50B99
Hand Honing (dry)	Various sizes Type HH1 or HH2		ASD100-R100B99 SD320-100V99
Lamination Dies (wet)	Various sizes Type 1A1	Surface grinding of carbide	ASD120-R75B99
Surface Grinding (wet) • Straight Wheels	Various sizes Type 1A1	Roughing • Durable • Free cutting Finishing only General purpose	ASD100S-R100B99E* SD100S-R100B99 SD220-R100B99 ASD150-R75B99
Tool & Cutter Grinding	Various sizes Type 11V9, 12V9 or 15V9	Wet or dry	ASD120-R7599
<b>CARBIDE GRINDING – OFFHAND</b>			
Single-Point Carbide Tools	6" x 3/4" x 1-1/4" Type 6A2C ME27853	Wet roughing • Durable • Free cutting Wet finishing • Durable • Free cutting Wet or dry grinding where free-cutting and self-dressing wheels are required • Roughing • Finishing	RMD150-P50V99* SD150-P50V99 RMD220-P50V99* SD220-P50V99 ASD120-R75B99 SD220-R50B99E*

Note: Diamond depths are not indicated in above listings. When ordering, be sure to include Diamond depth (1/16, 1/8, etc.).  
\*Non-stock: Refer to the B99E Express Made-to-Order Wheel section.

# SPECcheck

## CBN WHEEL STARTING RECOMMENDATIONS

APPLICATION OR COMMON MACHINE TYPE	COMMON WHEEL SIZE, TYPE & BLUEPRINT	APPLICATION VARIABLES	RECOMMENDED SPECIFICATION
<b>TOOLROOM GRINDING</b>			
Cutter Sharpening • Milling Cutters, Broaches, Reamers, etc.	3-3/4" x 1-1/2" x 1-1/4" Type 11V9 ME92192	Dry Wet	Aztec III 120T CB120-TB99
	6" x 1" x 1-1/4" Type 12A2 ME27758	Wet or dry	CB120-TB99
	6" x 3/4" x 1-1/4" Type 12V9 ME48666	Wet or dry	CB120-TB99
	6" x 3/4" x 1-1/4" Type 15V9 ME40633	Wet or dry	CB100-WB99E*
	10" x 1/2" x 3" Type 1A1	Wet or dry	CB100-TB99E*
Cylindrical Grinding	12" x 1/2" x 3" Type 1A1	Wet or dry	CB150-WB99E*
Internal Grinding Tools	Thinner than 1/2" Type DW	Wet or dry	CB100-WB99
	1/2" or thicker Type 1A1	Wet or dry	CB120-TB99E*
	Slotting 7" x .040" x 1-1/4" Type 1A1R	Water-base coolant	CB120-WB99E*

Note: cBN depths are not indicated in above listings. When ordering, be sure to include cBN depth (1/16, 1/8, etc.)

\* B99 Express made-to-order: Refer to the B99E Express Made-To-Order wheel section.



SIZE D x T	SPECIFICATION	UPC #
<b>TYPE DW MOUNTED POINTS – DIAMOND</b>		
1/8 x 1/4	SD220-R100B99-SOLID	69014192236
Steel Spindle 1/8 x 1-1/2		
3/16 x 1/4	SD100-R100B99-SOLID	69014192238
Steel Spindle 1/8 x 1-1/2		
1/4 x 1/4	SD100-R100B99-SOLID	69014192240
Steel Spindle 1/8 x 1-1/2		
3/8 x 1/4	SD100S-R100B99-SOLID	69014192243
Steel Spindle 1/8 x 1-1/2		
1/2 x 1/2	SD100S-R100B99-SOLID	69014192248
Steel Spindle 1/4 x 1-1/2	SD220-R100B99-SOLID	69014192249
3/4 x 3/8	SD150-R100B99-SOLID	69014192251
Steel Spindle 1/4 x 1-1/2		
1 x 1/2	SD100-R100B99-SOLID	69014192428
Steel Spindle 1/4 x 1-1/2		
<b>TYPE DW MOUNTED POINTS – cBN</b>		
3/16 x 1/4	CB150-WB99-SOLID	69014192258
Carbide Spindle .125 x 1-3/4		
1/4 x 1/4	CB120-WB99-SOLID	69014192260
Carbide Spindle .125 x 1-3/4		
1/2 x 1/2	CB100-WB99-SOLID	69014192272
Carbide Spindle .250 x 2-1/4		
3/4 x 1/4	CB100-WB99-SOLID	69014192276
Carbide Spindle .250 x 2-1/4		
1 x 1/4	CB100-WB99-SOLID	69014192277
Carbide Spindle .250 x 2-1/4		
SIZE T x W x L	SPECIFICATION	UPC #
<b>TYPE HH1 HAND HONES – DIAMOND</b>		
1/4 x 1/4 x 6	ASD220-R100B99-1/16	69014192139
One 1/16 deep 1" long insert in one 1/4 surface		
1/4 x 3/8 x 4	ASD100-R100B99-1/16	69014192141
One 1/16 deep 1" long insert in one 3/8 surface	ASD180-R100B99-1/16	69014192142
1" long insert in one 3/8 surface	ASD220-R100B99-1/16	69014191670
	ASD320-R100B99-1/16	69014191672
	ASD400-R100B99-1/16	69014192143
	D10/20MIC-R100B99-1/16	69014192144
	SD220-100V99-1/16	69014191671
	SD320-100V99-1/16	69014192140
<b>TYPE HH2 HAND HONES – DIAMOND</b>		
1/4 x 3/8 x 4	ASD120/220-R100B99-1/16	69014192150
Two 1/16 deep 1" long inserts in one 3/8 surface	ASD150/320-R100B99-1/16	69014192177
	ASD220/320-R100B99-1/16	69014192178
	ASD220/400-R100B99-1/16	69014192179
	ASD320/400-R100B99-1/16	69014192180
	SD220/320-100V99-1/16	69014192149
	SD320/400-100V99-1/16	69014192182

### Type DW

D - DIAMETER  
T - THICKNESS  
Y - SPINDLE DIAMETER  
SP - SPINDLE LENGTH

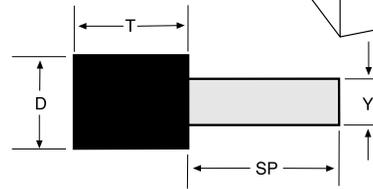

### Type HH1

L - LENGTH  
L1 - LENGTH OF ABRASIVE  
X - ABRASIVE DEPTH  
W - WIDTH  
T - THICKNESS (BACK)

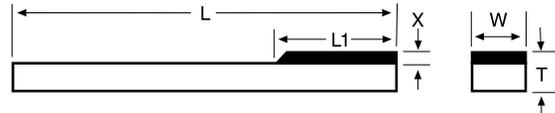

### Type HH2

L - LENGTH  
L1 - LENGTH OF ABRASIVE  
X - ABRASIVE DEPTH  
W - WIDTH  
T - THICKNESS (BACK)

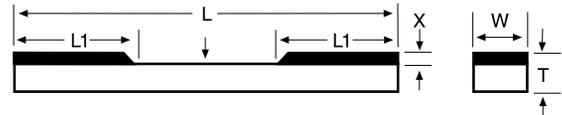

### CAN'T FIND YOUR SPECIFICATION HERE?

CHECK OUT THE NORTON/WINTER TOOLROOM SECTION. THEN REFER TO OUR B99 EXPRESS MADE-TO-ORDER RESIN WHEEL SECTION.

The Norton B99 Express service is designed to offer you up to 65,000 made-to-order choices of resin bond Diamond and cBN wheels. Almost all popular sizes are offered. Size and shape availability are shown.

12" and less diameter B99 Express wheels will ship in two weeks or less from the date the order is received by Norton. 14" and larger wheels are available at standard lead-times.

SIZE D x T x H	SPECIFICATION	UPC #
<b>TYPE 1A1 STRAIGHT – DIAMOND</b>		
3/4 x 1/4 x 1/4	ASD150-R100B99-1/8	69014192174
1 x 1/4 x 1/4	SD100-R100B99-1/8	69014192175
1-1/2 x 1/2 x 1/2	D6/12MIC-N100B99-1/8	69014192176
2 x 1/8 x 1/4	SD100-R100B99-1/8	69014192184
3 x 1/4 x 3/4	SD180-N100B99-1/8	69014192187
4 x 1/32 x 1-1/4	SD100S-R100B99-1/4	69014192192
4 x 1/16 x 1-1/4	SD100S-R100B99-1/4	66260273583
	SD150-R100B99-1/4	66260273584
	SD220-R100B99-1/4	66260273586
4 x 1/8 x 3/4	SD150-R100B99-1/4	69014192024
4 x 1/8 x 1-1/4	SD150-R100B99-1/4	69014191677
4 x 1/4 x 1/2	SD150-R100B99-1/4	66260273590
4 x 1/4 x 3/4	SD150-R100B99-1/4	66260273592
4 x 1/4 x 1-1/4	SD100S-R100B99-1/4	66260273587
	SD120-R100B99-1/4	66260273588
	SD150-R100B99-1/4	66260273589
4 x 1/2 x 1-1/4	SD150-R100B99-1/4	66260273594
6 x 1/32 x 1-1/4	SD220-R100B99-1/4	69014192197
6 x 1/16 x 1-1/4	SD100-R100B99-1/4	66260273596
	SD150-R100B99-1/4	66260273597
	SD180-R100B99-1/4	66260273598
	SD220-R100B99-1/4	66260273599
6 x 1/8 x 1-1/4	ASD150-R75B99-1/4	66260273617
	SD100-R100B99-1/4	66260273611
	SD120-R100B99-1/4	66260273612
	SD150-R100B99-1/4	66260273613
	SD180-R100B99-1/4	66260273614
	SD220-R100B99-1/4	66260273615
6 x 1/4 x 1-1/4	ASD100S-R75B99-1/4	69014192205
	ASD120-R75B99-1/4	69014192769
	ASD150-R75B99-1/4	66260273609
	ASD180-R75B99-1/4	69014192770
	ASD220-R75B99-1/4	69014192771
	ASD320-R75B99-1/4	69014192772
	RMD180-P100V99-1/8	69014192203
	SD120-R100B99-1/4	69014191691
	SD150-R100B99-1/4	69014191692
	SD180-R100B99-1/4	69014191693
	SD220-R100B99-1/4	69014192764
6 x 3/8 x 1-1/4	ASD120-R75B99-1/4	69014192773
	ASD150-R75B99-1/4	69014191695
	SD150-R100B99-1/4	69014191696
6 x 1/2 x 1-1/4	ASD120-R75B99-1/4	69014192777
	ASD150-R75B99-1/4	69014191698
	ASD220-R75B99-1/4	69014192779
	ASD320-R75B99-1/4	69014192780
	SD120-R100B99-1/4	66260273557
	SD150-R100B99-1/4	66260273561
	SD180-R100B99-1/4	69014191700
7 x 1/4 x 1-1/4	ASD150-R75B99-1/8	69014191701
	SD100S-R100B99-1/4	69014192210
	SD120-R100B99-1/4	66260273566
	SD150-R100B99-1/4	69014191703
	SD180-R100B99-1/4	69014191704
	SD220-R100B99-1/4	69014191705
7 x 3/8 x 1-1/4	ASD150-R75B99-1/4	69014191848
	SD120-R100B99-1/4	69014191849
	SD220-R100B99-1/4	69014191852
7 x 1/2 x 1-1/4	ASD100-R75B99-1/4	69014192211
	ASD150-R75B99-1/4	69014191853
	ASD180-R75B99-1/4	69014192212
	SD120-R100B99-1/4	69014191854
	SD150-R100B99-1/4	69014191855
	SD180-R100B99-1/4	69014191856
	SD220-R100B99-1/4	69014191857
8 x 1/2 x 1-1/4	SD150-R100B99-1/4	66260273574

STANDARD PACKAGE = 1 MOUNTED POINT, HAND HONE, OR WHEEL  
CONTINUED

SIZE D x T x H	SPECIFICATION	UPC #
<b>TYPE 1A1 STRAIGHT – DIAMOND (CONT'D)</b>		
10 x 1/2 x 3	ASD120-R75B99-1/4	69014192305
	ASD180-R100B99-1/4	69014192306
12 x 1/2 x 3	ASD150-R75B99-1/4	69014192310
12 x 1/2 x 5	ASD150-R75B99-1/4	69014192311
12 x 1 x 3	ASD120-R75B99-1/4	69014192312
12 x 1 x 5	ASD120-R75B99-1/4	69014192313
14 x 1/2 x 5	ASD150-R75B99-1/4	69014192314
14 x 1 x 5	ASD120-R75B99-1/4	69014192316
20 x 1 x 12	ASD120-R75B99-1/4	69014192325
<b>TYPE 1A1 STRAIGHT – cBN</b>		
6 x 1/8 x 1-1/4	CB120-TB99-1/4	66260273601
6 x 1/4 x 1-1/4	CB120-TB99-1/4	66260273605
6 x 1/2 x 1-1/4	CB120-TB99-1/4	66260273607
7 x 1/4 x 1-1/4	CB120-TB99-1/4	69014192021
7 x 1/2 x 1-1/4	CB120-TB99-1/4	66260273567
12 x 1/2 x 5	CB150-TB99-1/4	66260273560
12 x 1 x 5	CB150-TB99-1/4	66260273562

STANDARD PACKAGE = 1 WHEEL

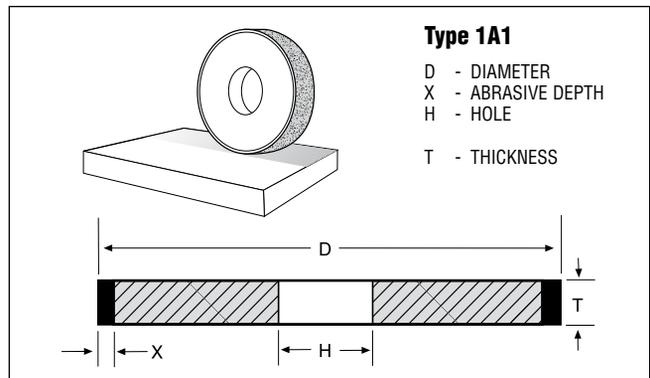

**NOTE: 1A1 NORTON STOCK WHEELS WITH 1/8" DIAMOND DEPTH HAVE BEEN CONVERTED TO 1/4" DEPTH – AND PRICED TO DELIVER EXCEPTIONAL VALUE!**

## TECHtip

### CYLINDRICAL GRINDING APPLICATIONS – 1A1 WHEELS:

- Includes all outside grinding of round parts, even though the finished product is not always a true cylinder.
- Infeed at both ends of the traverse to keep wheel face flat.
- Use work supports to prevent deflection.
- Rough grinding traverse speed should be 1/2 to 2/3 of the thickness of the wheel per work revolution.
- Finishing grinding traverse speed should be 1/2" or less per work revolution.

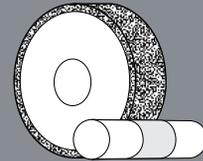

It is the user's responsibility to refer to and comply with ANSI B7.1

### DIAMOND GRINDS:

- Cemented carbide
- Glass
- Ceramics
- Fiberglass
- Plastics
- Stone
- Abrasives
- Electronic components and materials

### CBN GRINDS:

- High-speed tool steels
- Die steels
- Hardened carbon steels
- Alloy steels
- Aerospace alloys
- Hard stainless steel
- Abrasion-resistant ferrous materials

SIZE D x T x H	SPECIFICATION	UPC #
<b>TYPE 1A1R CUT-OFF – DIAMOND</b>		
3 x .020 x 1/2 (ME104177)	M4D150-N50M99-1/8	69014192060
4 x .012 x 1/2 (ME104180)	M4D180-N75M99-1/8	69014192063
4 x .020 x 1/2 (ME104180)	M4D220-N75M99-1/8	69014192064
4 x .020 x 1/2 (ME104180)	M4D220-N100M99-1/8	69014192067
4 x .030 x 1/2 (ME104180)	M4D150-N75M99-1/8	69014192068
4 x 1/32 x 3/4 (ME43570)	SD100S-R100B99-1/4	69014192151
4 x 1/32 x 1-1/4 (ME43570)	SD120-R100B99-1/4	69014191706
4 x 1/32 x 1-1/4 (ME43570)	SD100S-R100B99-1/4	69014192152
5 x .015 x 1/2 (ME104180)	M4D150-N100M99-1/8	69014192069
6 x .017 x 1-1/4 (ME104180)	M4D220-N100M99-1/8	69014192070
6 x .017 x 1-1/4 (ME104180)	M4D150-N100M99-1/8	69014192082
6 x .025 x 1-1/4 (ME104180)	M4D220-N100M99-1/8	69014192083
6 x .025 x 1-1/4 (ME104180)	M4D150-N100M99-1/8	69014192086
6 x .035 x 5/8 (ME104177)	M4D100-N75M99-1/8	69014192088
6 x .035 x 1-1/4 (ME43572)	ASD120-R75B99-1/4	69014191707
	SD100-R75B99-1/4	69014192155
	ASD100S-R100B99-1/4	69014192158
	ASD120-R100B99-1/4	69014192159
	SD100-R100B99-1/4	69014191858
	SD100S-R100B99-1/4	69014192156
	SD220-R100B99-1/4	69014192157
6 x .035 x 1-1/4 (ME73316)	ASD100S-R100B99-9/32	69014192164
	ASD120-R100B99-9/32	69014192165
	SD100-R100B99-9/32	69014192161
	SD120-R100B99-9/32	69014192162
	SD150-R100B99-9/32	69014192163
6 x .045 x 1-1/4 (ME83991)	SD100-R50B99-1/8	69014192166
6 x .055 x 1-1/4 (ME104177)	M4D100-N75M99-1/8	69014192099
7 x .035 x 1-1/4 (ME82347)	ASD100-R100B99-1/4	66260238686
7 x .040 x 1-1/4 (ME104177)	M4D120-N75M99-1/8	69014192105
7 x .055 x 1-1/4 (ME104177)	M4D120-N100M99-1/8	69014192108
8 x .030 x 1-1/4 (ME104180)	M4D180-N75M99-1/8	69014192110
8 x .045 x 5/8 (ME43569)	SD120-R100B99-1/4	69014192167
8 x .045 x 1 (ME43569)	SD120-R100B99-1/4	69014192168
8 x .045 x 1-1/4 (ME43569)	SD120-R100B99-1/4	69014192169
8 x .050 x 1-1/4 (ME104180)	M4D180-N75M99-1/8	69014192114
10 x .050 x 1-1/4 (ME 43565)	ASD120-R100B99-1/4	66260230236
	CD100-R100B99-1/4	69014192815
	SD120-R100B99-1/4	69014192170
10 x .050 x 3 (ME 43565)	ASD100S-R75B99-1/4	69014192172
12 x .070 x 3/4 (ME 43567)	SD150-R100B99-1/4	69014192173
14 x .070 x 3/4 (ME 106589)	SD120-R100B99-1/4	66260259011
<b>TYPE 1A1R CUT-OFF – cBN</b>		
6 x .035 x 1-1/4 (ME43572)	CB100-WB99-1/4	69014192160

SIZE D x T x H	SPECIFICATION	UPC #
<b>TYPE 1V1P FLUTING – DIAMOND</b>		
6 x 3/32 x 1-1/4	ASD320B-R125B99-1/4	69014192302
Face Bevel 1 Side	ASDC320C-R100B99-1/4	69014192761
20 Deg		
Copper Core		
(ME89562)		
<b>STANDARD PACKAGE = 1 WHEEL</b>		

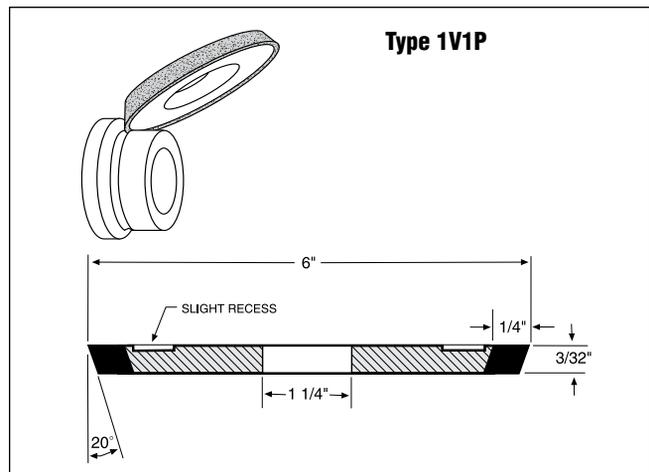
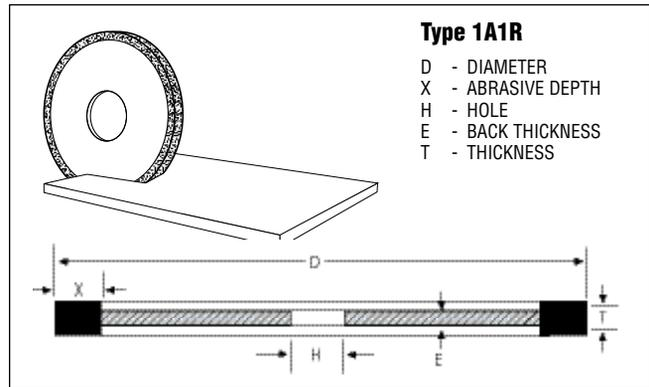

## TECHtip

### CUT-OFF APPLICATIONS – 1A1R WHEELS:

- Use the largest diameter flanges possible
- Use flanges of equal diameter
- Use the thickest wheel possible for increased stiffness and straightness of cut

cBN wheels are used on hardened steels. Diamond wheel are used to cut or slot carbide, glass or ceramic parts.

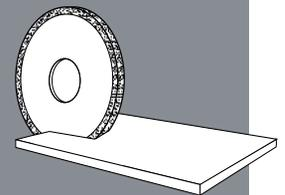

It is the user's responsibility to refer to and comply with ANSI B7.1

SIZE D x T x H	SPECIFICATION	UPC #
<b>TYPE 4A2P DISH – DIAMOND</b>		
6 x 3/8 x 1-1/4 Rim Width 1/4" (ME88369)	ASD120-R75B99-1/16	69014192280
<b>TYPE 6A2C STRAIGHT CUP – DIAMOND</b>		
6 x 7/16 x 1-1/4 Rim Width 1" (0640185M)	D120/140-H-MSL	66260269172
6 x 3/4 x 1-1/4 Rim Width 3/4" (ME27853)	SD220-R50B99-1/16 ASD120-R75B99-1/16 ASD120-R75B99-1/8 SD150-P50V99-1/16 SD220-P50V99-1/16	69014191665 69014191860 69014192786 69014192217 69014191623
6 x 3/4 x 1-1/4 Rim Width 1/2" (ME30621)	ASD120-R75B99-1/8	66260273565

**STANDARD PACKAGE = 1 WHEEL**

SIZE D x T x H	SPECIFICATION	UPC #
<b>TYPE 6A2H STRAIGHT CUP – DIAMOND</b>		
5 x 1 x 1-1/4 Rim Width 1-1/16" (ME27084)	SD320-R50B99-1/16	69014192221
<b>TYPE 11A2 FLARING CUP – DIAMOND</b>		
6 x 1-1/2 x 1-1/4 Rim Width 1/4" (ME128467)	ASD150-R100B99-1/4	69014192799

**STANDARD PACKAGE = 1 WHEEL**

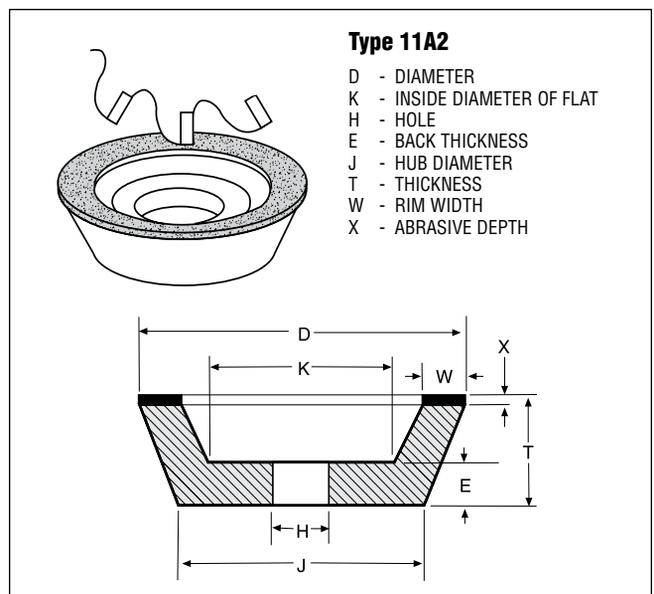
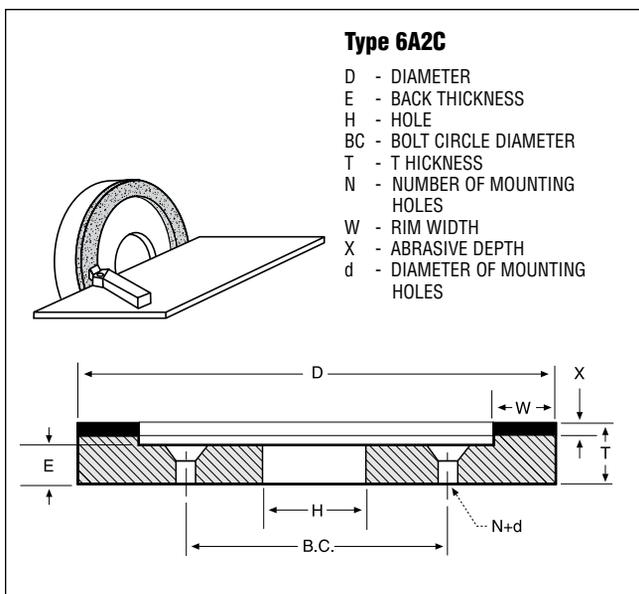
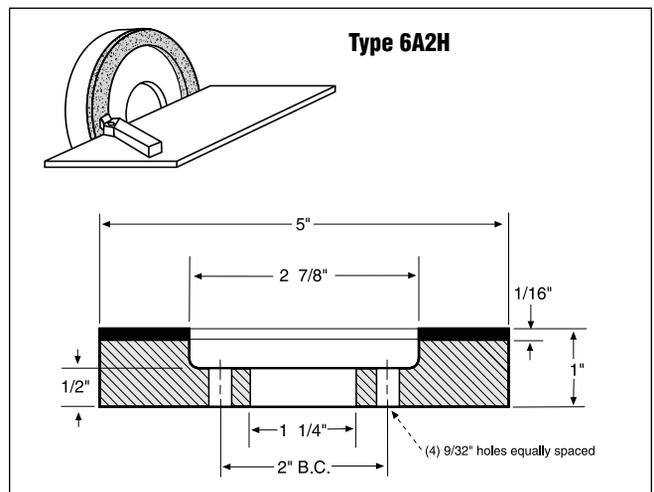
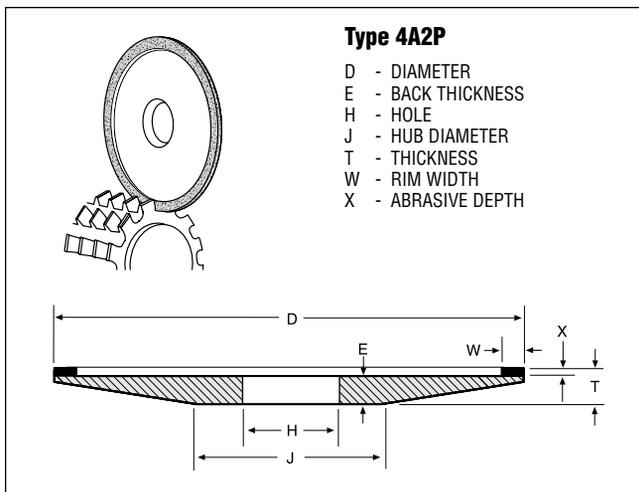

REFER TO "BRAKE CONTROLLED TRUING DEVICES" AND "DRESSING STICKS" SECTIONS FOR TRUING AND DRESSING PRODUCTS.

## BEST

## ASD DIAMOND / B105 RESIN BOND WHEELS – IDEAL FOR DRY GRINDING CARBIDE TOOLS

FEATURES	BENEFITS
■ Premium quality diamond	■ Produces keen cutting tools that hold their shape, are easier to sharpen, and require fewer reconditionings
■ Advanced, heat-reducing bond	■ Minimizes heat generation and thermal damage to tool ■ Increases tool life and productivity ■ Lasts more than 2X as long as standard diamond wheels ■ Lowest total wheel costs; highest productivity
■ Self-lubricating bond	■ No steel or braze loading ■ Uses less power
■ Unique self-dressing core	■ Eliminates wheel core damage ■ Eliminates downtime to dress core

SIZE D x T x H	SPECIFICATION	UPC #
<b>TYPE 11V9 FLARING CUP – DIAMOND</b>		
3-3/4 x 1-1/2 x 1-1/4	ASD100S-R75B105-1/16	69014191904
Insert Length 3/8" (ME92192)	ASD120-R75B105-1/16	69014191905
	ASD150-R75B105-1/16	69014191906
	ASD100S-R75B105-1/8	69014191908
	ASD120-R75B105-1/8	69014191909
	ASD150-R75B105-1/8	69014191910
5 x 1-3/4 x 1-1/4	ASD120-R75B105-1/16	69014191913
Insert Length 7/16" (ME98298)	ASD150-R75B105-1/16	69014191914
	ASD100S-R75B105-1/8	69014191916
	ASD120-R75B105-1/8	69014191917
	ASD150-R75B105-1/8	69014191918

STANDARD PACKAGE = 1 WHEEL

SIZE D x T x H	SPECIFICATION	UPC #	
<b>TYPE 11V9 FLARING CUP – DIAMOND</b>			
3 x 1-1/4 x 3/4	ASD120-R75B99-1/16	69014192291	
Insert Length 3/8" (ME93912)	ASD150-R75B99-1/16	69014192292	
	SD150-R100B99-1/16	69014192293	
3-3/4 x 1-1/2 x 3/4	ASD120-R75B99-1/16	69014192022	
Insert Length 3/8" (M92192)	ASD150C-R50B99-1/8	69014190751	
	ASD120-R75B99-1/16	69014191660	
Insert Length 3/8" (ME92192)	ASD150-R75B99-1/16	69014191725	
	ASD180-R75B99-1/16	69014191658	
	ASD220-R75B99-1/16	69014192363	
	ASD100S-R75B99-1/8	69014191653	
	ASD120-R75B99-1/8	69014191652	
	ASD150-R75B99-1/8	69014191651	
	ASD180-R75B99-1/8	69014191650	
	SD120-R100B99-1/16	69014191657	
	SD150-R100B99-1/16	69014191656	
	SD220-R100B99-1/16	69014191654	
	SD320-R100B99-1/16	69014192814	
	SD100S-R100B99-1/8	69014192427	
	SD120-R100B99-1/8	69014191649	
	SD150-R100B99-1/8	69014191648	
	SD180-R100B99-1/8	69014191647	
	SD220-R100B99-1/8	69014191646	
	5 x 1-3/4 x 1-1/4 Insert Length 7/16" (ME98298)	ASD100S-R75B99-1/16	69014191645
		ASD120-R75B99-1/16	69014191644
		ASD150-R75B99-1/16	69014191643
		ASD100S-R75B99-1/8	69014191637
ASD120-R75B99-1/8		69014191636	
ASD150-R75B99-1/8		69014191635	
ASD180-R75B99-1/8		69014191634	
ASD320-R75B99-1/8		69014192810	
SD120-R100B99-1/16		69014191641	
SD150-R100B99-1/16		69014191640	
SD180-R100B99-1/16		69014191639	
SD220-R100B99-1/16		69014191638	
SD150-R100B99-1/8	69014191632		
SD180-R100B99-1/8	69014191631		

STANDARD PACKAGE = 1 WHEEL

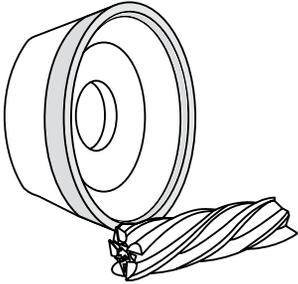

**Type 11V9**

- D - DIAMETER
- K - INSIDE DIAMETER OF FLAT
- H - HOLE
- E - BACK THICKNESS
- T - THICKNESS
- J - HUB DIAMETER
- U - INSERT LENGTH
- X - ABRASIVE DEPTH
- S - FACE ANGLE

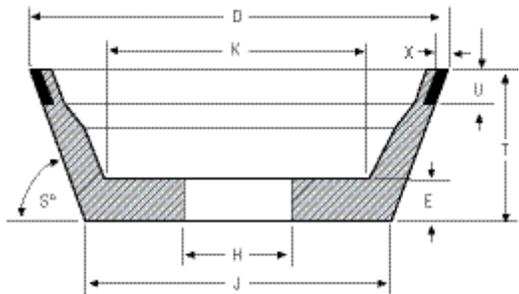

## BEST

## NORTON AZTEC cBN WHEELS – IDEAL FOR DRY RESHARPENING OF STEEL TOOLS

FEATURES	BENEFITS
<ul style="list-style-type: none"> <li>Consistent, high quality cBN (cubic Boron Nitride) abrasive</li> </ul>	<ul style="list-style-type: none"> <li>85% longer life than standard cBN wheels</li> </ul>
<ul style="list-style-type: none"> <li>Advanced heat-reducing bond conducts heat away from the workpiece</li> </ul>	<ul style="list-style-type: none"> <li>Eliminates heat build-up and damage</li> <li>Extends wheel life</li> <li>Freer cutting action</li> <li>Maintains cutting tool steel integrity</li> <li>Extends cutting tool life</li> </ul>

### Aztec III

<ul style="list-style-type: none"> <li>Lubricating bond</li> </ul>	<ul style="list-style-type: none"> <li>Eliminates steel and braze loading</li> <li>Reduces drag</li> <li>Allows greater infeeds</li> </ul>
--------------------------------------------------------------------	--------------------------------------------------------------------------------------------------------------------------------------------

### Aztec .007

<ul style="list-style-type: none"> <li>Allows increased infeed (start at .007)</li> </ul>	<ul style="list-style-type: none"> <li>High stock removal rate</li> <li>Heaviest cuts with less wheel wear</li> <li>Lower grinding forces</li> <li>Elimination of chatter</li> </ul>
-------------------------------------------------------------------------------------------	--------------------------------------------------------------------------------------------------------------------------------------------------------------------------------------

SIZE D x T x H	SPECIFICATION	UPC #
<b>TYPE 11V9 FLARING CUP – cBN</b>		
3-3/4 x 1-1/2 x 1-1/4	AZTEC .007-100-1/16	69014195683
Insert Length 3/8"	AZTEC .007-150-1/16	69014195679
(ME92192)	AZTEC III 100T-1/16	69014191832
	AZTEC III 120T-1/16	69014191833
	AZTEC III 150T-1/16	69014191834
	AZTEC .007-150-1/8	69014195680
	AZTEC III 100T-1/8	69014191838
	AZTEC III 120T-1/8	69014191839
	AZTEC III 150T-1/8	69014191840
	AZTEC III 100W-1/16	69014191835
	AZTEC III 150W-1/16	69014191837
5 x 1-3/4 x 1-1/4	AZTEC .007-100-1/16	69014195685
Insert Length 7/16"	AZTEC III 100T-1/16	69014191841
(ME98298)	AZTEC III 120T-1/16	69014191842
	AZTEC III 150T-1/16	69014191843
	AZTEC .007-100-1/8	69014195686
	AZTEC .007-150-1/8	69014195682
	AZTEC III 100T-1/8	69014191844

SIZE D x T x H	SPECIFICATION	UPC #
<b>TYPE 11V9 FLARING CUP – cBN</b>		
3-3/4 x 1-1/2 x 1-1/4	CB100-TB99-1/16	69014191719
Insert Length 3/8"	CB100-TB99-1/8	69014191722
(ME92192)	CB120-TB99-1/8	69014191723
	CB150-TB99-1/8	69014191724
	CB120-WB99-1/16	69014191720
	CB150-WB99-1/16	69014191721
5 x 1-3/4 x 1-1/4	CB120-TB99-1/8	69014191715
Insert Length 7/16"	CB150-TB99-1/8	69014191716
(ME98298)		

### STANDARD PACKAGE – 1 WHEEL

### STANDARD PACKAGE = 1 WHEEL

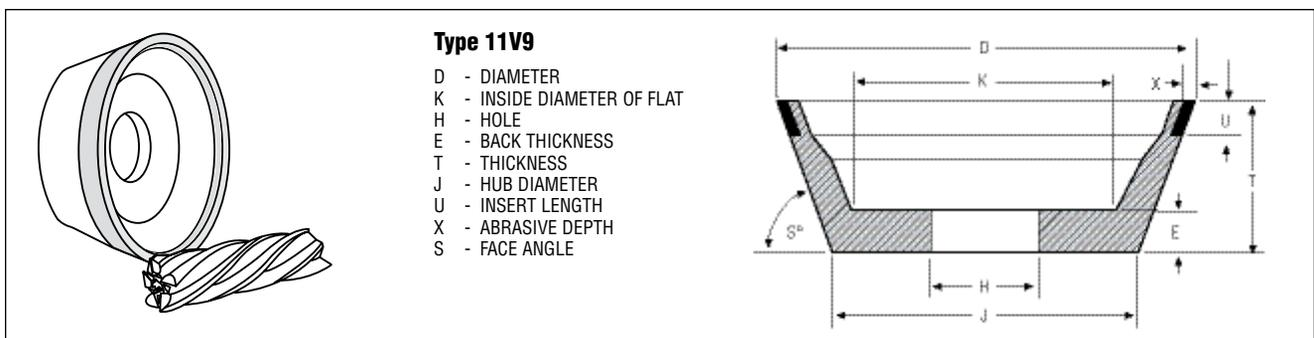

SIZE D x T x H	SPECIFICATION	UPC #
<b>TYPE 12A2 DISH – DIAMOND</b>		
4 x 1/2 x 1-1/4 Rim Width 1/4" (ME40745)	SD180-R75B99-1/8	69014192223
6 x 1 x 1-1/4 Rim Width 3/16" (ME27758)	ASD120-R75B99-1/8 ASD180-R75B99-1/8	69014191630 69014192226
<b>TYPE 12A2 DISH – cBN</b>		
6 x 1 x 1-1/4 Rim Width 3/16" (ME27758)	CB120-TB99-1/16	69014192227
<b>TYPE 12V9 DISH – DIAMOND</b>		
3 x 7/16 x 3/4 Insert Length 7/16" (ME41755)	SD150-R100B99-1/16	69014192228
4 x 1/2 x 1-1/4 Insert Length 1/4" (ME58734)	SD180-R100B99-1/8	69014191629
6 x 3/4 x 1-1/4 Insert Length 3/8" (ME48666)	ASD150-R75B99-1/16	69014191628
<b>TYPE 12V9 DISH – cBN</b>		
4 x 1/2 x 1-1/4 Insert Length 1/4" (ME58734)	CB120-TB99-1/8	69014192229
6 x 3/4 x 1-1/4 Insert Length 3/8" (ME48666)	CB120-TB99-1/8 CB150-TB99-1/8	69014192020 69014192784
<b>TYPE 15V9 DISH – DIAMOND</b>		
6 x 3/4 x 1-1/4 Insert Length 3/8" (ME40633)	SD150-R100B99-1/16	69014192230

STANDARD PACKAGE = 1 WHEEL

**NORTON OFFERS A COMPREHENSIVE STOCK PRODUCT SELECTION TO SERVICE MOST OF YOUR NEEDS – WITH THE FASTEST DELIVERY AND LOWEST PRICES. SEE THESE CATALOG SECTIONS FIRST:**

- Norton Stock B99 Products
- Norton/Winter Stock Toolroom Products

**Can't find the specification in the above sections?**

Then refer to the Norton B99 Express Made-to-Order Resin Product section.

**If a product can not be found in the B99 Express offering:**

Contact your Norton sales representative or distributor for a custom-made product recommendation.

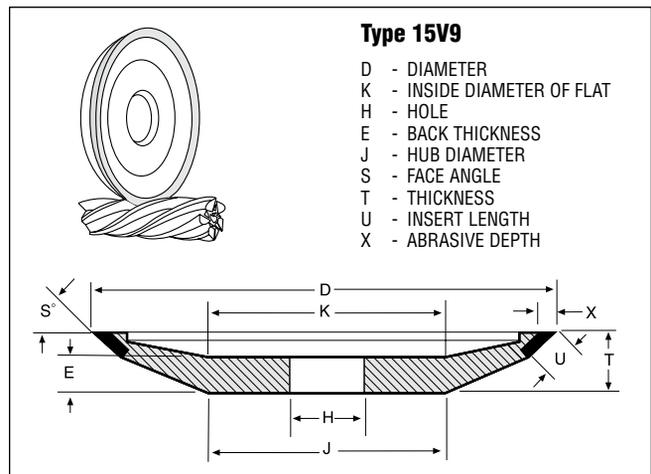
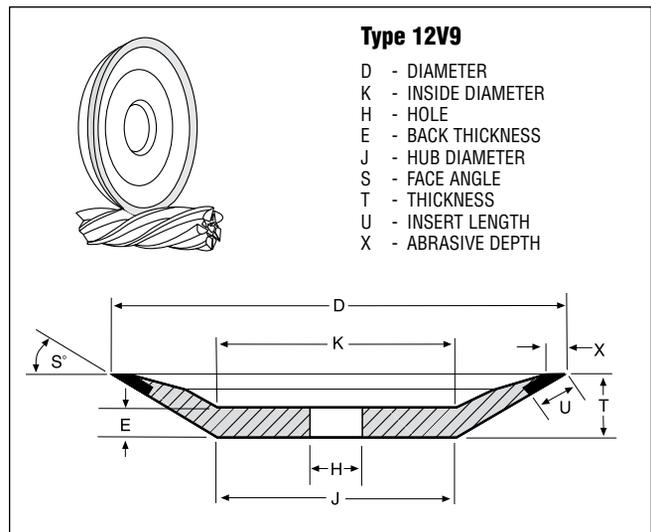
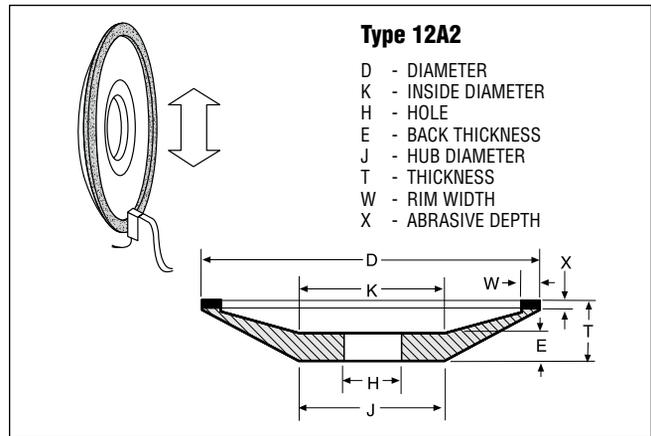

**NORTON B99 EXPRESS  
MADE-TO-ORDER RESIN PRODUCTS**

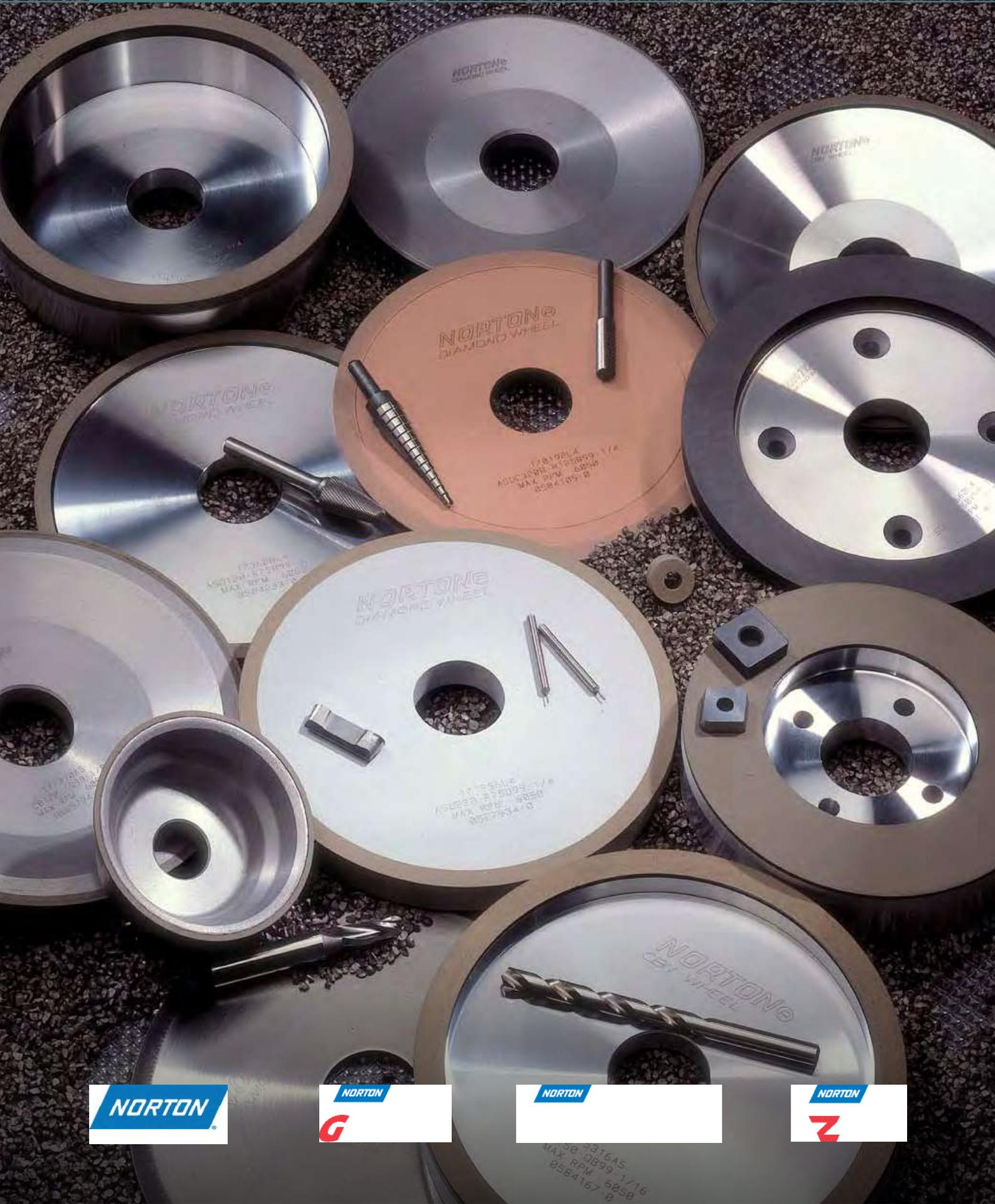



65,000+ made-to-order resin products; 25 wheel shapes, with 2 week lead-times for 12" and less diameter wheels. 14" and larger wheels and 80 grit and coarser wheels are available with standard made-to-order lead-times. If you do not find the resin specification and/or shape you need in our stock offering, you will most likely find it in our B99 Express made-to-order offering.

**TYPICAL APPLICATIONS**

**Norton B99E Diamond Wheels**

- Sharpening cemented carbide cutting tools
- Cutting off carbide rod
- Grinding or cutting off non-metallic materials such as ceramics or glass
- Surface grinding dies
- O.D. grinding spray coatings

**Norton B99E cBN Wheels**

- Sharpening high-speed (M2, D2, T15, etc.) steel cutting tools
- Surface and ID grinding hardened steel die components
- Precision grinding steel parts Rc 50 or harder



**BETTER**

**B99 EXPRESS DIAMOND AND cBN WHEELS**

**FEATURES**

- Superior diamond and cBN abrasives in durable resin bond systems
- Thousands of abrasive, grit, grade, concentration, and bond combinations
- Made in our state-of the art, USA, ISO-certified facilities
- Priced as stock products
- Two week (and less) lead-times

**BENEFITS**

- These quality wheels will get your job done
- There is a B99 Express wheel for almost every resin bond application
- Exceptional quality and performance
- Excellent performance/price ratio
- Minimal time from order to production floor

**HOW TO SELECT B99 EXPRESS MADE-TO-ORDER DIAMOND WHEELS**

**SELECT**

SHAPE			Use the “Wheel Shape Index” to determine shape and availability.
WHEEL DIMENSIONS	D x T x H	<b>Select Diameter x Thickness x Hole from the availability tables.</b> Use blueprint numbers where available.	
ABRASIVE	ASD SD	<b>Armored diamond; most durable.</b> Versatile: can be used wet or dry. ASD should be used when carbide and steel are ground in the same operation. <b>Free cutting standard.</b> Can be used wet or dry; should be used on low horsepower (3/4 hp or less) machines.	Select the abrasive based on horsepower, grinding wet or dry, and contact with steel.
GRIT SIZE	80 100 120 150 180 220 320 400	<b>Roughing</b> <b>Roughing.</b> The most common grit size for roughing operations. <b>For roughing where 100 is too coarse.</b> Also for cut-off applications. <b>Medium stock removal plus good finish.</b> For combined roughing and finishing applications. <b>Medium stock removal plus good finish.</b> To improve finish. <b>Finishing</b> <b>Finishing</b> <b>Fine finishing</b>	Select the grit size based on finish and material removal rate required. <b>Note:</b> Standrad made-to-order lead-times apply to 80 grit and coarser wheels.
GRADE	R	<b>Resin bond standard</b>	The hardness of the wheel
CONCENTRATION	50 75 100 125	<b>Shape 2A2T only.</b> For broad area of contact grinding. <b>Norton standard.</b> Freer cutting than 100 and the most economical for dry grinding with ASD diamond. <b>Very durable.</b> Recommended under flood coolant conditions. For use with 220 grit or finer, when durability is required. Also for cut-off applications. <b>Improved form holding.</b> Used with B99EF bond only for form holding in high-volume, high-pressure coolant applications. Used with ASD abrasive.	Select the abrasive concentration based on grinding wet or dry, material removal rates and form holding requirements.
BOND	B99E B99EF	<b>Norton standard pre-engineered resin bond.</b> Versatile enough to be used wet or dry on most tool making or resharpening applications as well as for grinding non-metallic materials such as ceramics or glass. Available in all shapes. <b>Improved form holding.</b> More durable than B99E. Improved heat dissipation in wet or dry applications. Available in wheel shapes 1V1, 1B1, 1E1, 1EE1, 1F1 and 1FF1.	Select the bond based on the material being ground and grinding application.
ABRASIVE DEPTH	1/16 1/8 1/4 1/2		Usable abrasive

**NORTON OFFERS A COMPREHENSIVE STOCK PRODUCT SELECTION TO SERVICE MOST OF YOUR NEEDS – WITH THE FASTEST DELIVERY AND LOWEST PRICES. SEE THESE CATALOG SECTIONS FIRST:**

- Norton Stock B99 Products
- Norton/Winter Stock Toolroom Products
- Norton CNC Products

**Can’t find the specification in the above sections?**

Then refer to the Norton B99 Express Made-to-Order Resin Product section.

**If a product can not be found in the B99 Express offering:**

Contact your Norton sales representative or distributor for a custom-made product recommendation.

**TECHtip**

**DIAMOND GRINDS:**

In general, diamond is used to grind non-ferrous materials, because it reacts with iron.

- Cemented carbide
- Glass
- Ceramics
- Fiberglass
- Plastics
- Stone
- Abrasives
- Electronic components and materials

**cBN GRINDS:**

cBN is used to grind ferrous materials.

- High-speed tool steels
- Die steels
- Hardened carbon steels
- Alloy steels
- Aerospace alloys
- Hardened stainless steel
- Abrasion-resistant ferrous materials

**HOW TO SELECT B99 EXPRESS MADE-TO-ORDER CBN WHEELS**

**SELECT**

SHAPE			Use the “Wheel Shape Index” to determine shape and availability.
WHEEL DIMENSIONS	<b>D x T x H</b>	<b>Select Diameter x Thickness x Hole from the availability tables.</b> Use blueprint numbers where available.	<b>Note:</b> Standard made-to-order lead-times apply to 14” and larger wheels.
ABRASIVE	<b>CB</b>	<b>Norton standard coated cBN (cubic Boron Nitride).</b> Optimized for high performance in resin bond systems.	Select Norton cBN abrasive to grind hard tool steels such as A2, D2, T15, etc., and tough alloy steels.
GRIT SIZE	<b>100</b> <b>120</b> <b>150</b> <b>180</b> <b>220</b> <b>320</b> <b>400</b>	<b>Roughing.</b> The most common grit size for roughing operations. <b>For roughing where 100 is too coarse.</b> Also for cut-off applications. <b>Medium stock removal plus good finish.</b> For combined roughing and finishing applications. <b>Medium stock removal plus good finish.</b> To improve finish. <b>Finishing</b> <b>Finishing</b> <b>Fine finishing</b>	Select the grit size based on finish and material removal rate required. <b>Note:</b> Standard made-to-order lead-times apply to 80 grit and coarser wheels.
GRADE	<b>T</b> <b>W</b> <b>Z</b>	<b>Norton standard.</b> Approximately 75 concentration, T is the first choice for lower horsepower equipment or wide area of contact between the wheel and the workpiece. Ideal for resharpening applications with 11V9, 12A2, 4A2P, and 15V9 wheel shapes when dry grinding. <b>Very Durable.</b> Approximately 100 concentration, W is recommended for high volume coolant operations: flute grinding from solid, flute polishing, surface, and cylindrical grinding. <b>Form holding.</b> Approximately 125 concentration, Z grade is extremely durable and is recommended where long life or form holding is required in high-volume, high-pressure coolant applications. Used with B99EF bond only.	The hardness of the wheel
BOND	<b>B99E</b> <b>B99EF</b>	<b>Norton standard resin bond.</b> Pre-engineered for optimal performance with cBN abrasive. Available in all shapes. <b>Improved form holding.</b> More durable than B99E. Improved heat dissipation in wet or dry applications. Available in wheel shapes 1V1, 1B1, 1E1, 1EE1, 1F1 and 1FF1.	Select the bond depending on the type of grinding application.
ABRASIVE DEPTH	<b>1/16</b> <b>1/8</b> <b>1/4</b> <b>1/2</b>		Usable abrasive

# NORTON B99 EXPRESS MADE-TO-ORDER RESIN PRODUCTS

D	T	X
<b>TYPE 1A1 – STRAIGHT WHEELS</b>		
1	1/16	1/8
1	3/32	1/8
1	1/8	1/8
1	1/4	1/8
1	3/8	1/8
1	1/2	1/8
1	5/8	1/8
1	3/4	1/8
1	1	1/8
1-1/8	1/4	1/8
1-1/8	1/2	1/8
1-1/8	5/8	1/8
1-1/4	1/16	1/8
1-1/4	1/8	1/8
1-1/4	1/4	1/8
1-1/4	3/8	1/8
1-1/4	1/2	1/8
1-1/4	3/4	1/8
1-3/8	1/4	1/8
1-3/8	1/2	1/8
1-1/2	1/16	1/8
1-1/2	1/8	1/8
1-1/2	1/4	1/8
1-1/2	3/8	1/8
1-1/2	1/2	1/8
1-1/2	3/4	1/8
1-1/2	1	1/8
1-3/4	3/16	1/8
1-3/4	1/8	1/8
1-3/4	1/4	1/8
1-3/4	1/2	1/8
1-3/4	1	1/8
2	1/16	1/8
2	3/32	1/8
		1/4
2	1/8	1/8
		1/4
2	3/16	1/8
		1/4
2	1/4	1/8
2	3/8	1/8
		1/4

CONTINUED

D	T	X
<b>TYPE 1A1 – STRAIGHT WHEELS (CONT'D)</b>		
2	1/2	1/8
		1/4
2	3/4	1/8
2	1	1/8
2-1/4	1/2	1/8
		1/4
2-1/2	1/4	1/8
		1/4
2-1/2	1/2	1/8
2-3/4	1/4	1/8
2-3/4	1/2	1/8
3	1/32	1/8
		1/4
3	1/16	1/8
		1/4
3	3/32	1/8
		1/4
3	1/8	1/8
		1/4
3	3/16	1/8
		1/4
3	1/4	1/8
		1/4
3	3/8	1/8
		1/4
3	1/2	1/8
		1/4
3	3/4	1/8
4	1/32	1/8
		1/4
4	1/16	1/8
		1/4
4	3/32	1/8
		1/4
4	1/8	1/8
		1/4
4	3/16	1/8
		1/4
4	1/4	1/8
		1/4
4	5/16	1/8
		1/4

CONTINUED

D	T	X
<b>TYPE 1A1 – STRAIGHT WHEELS (CONT'D)</b>		
4	3/8	1/8
		1/4
4	1/2	1/8
		1/4
4	3/4	1/8
		1/4
4	1	1/8
		1/4
5	1/32	1/8
		1/4
5	1/16	1/8
		1/4
5	3/32	1/8
		1/4
5	1/8	1/4
5	3/16	1/4
5	1/4	1/4
		1/2
5	3/8	1/4
		1/2
5	1/2	1/4
		1/2
6	1/32	1/4
6	1/16	1/4
6	3/32	1/4
6	1/8	1/4
6	3/16	1/4
6	1/4	1/4
		1/2
6	5/16	1/4
		1/2
6	3/8	1/4
		1/2
6	1/2	1/4
		1/2
6	5/8	1/4
		1/2
6	3/4	1/4
		1/2
6	1	1/4
		1/2
7	1/16	1/4
7	3/32	1/4
7	1/8	1/4
7	3/16	1/4
7	1/4	1/4
		1/2
7	5/16	1/4
		1/2
7	3/8	1/4
		1/2
7	1/2	1/4
		1/2
7	1	1/4
		1/2
8	1/16	1/4
8	3/32	1/4
8	1/8	1/4
8	3/16	1/4
8	1/4	1/4
		1/2
8	3/8	1/4
		1/2

CONTINUED

D	T	X
<b>TYPE 1A1 – STRAIGHT WHEELS (CONT'D)</b>		
8	1/2	1/4
		1/2
8	5/8	1/4
		1/2
8	3/4	1/4
		1/2
8	1	1/4
		1/2
9	1/2	1/4
		1/2
10	1/4	1/4
		1/2
10	3/8	1/4
		1/2
10	1/2	1/4
		1/2
10	3/4	1/4
		1/2
10	1	1/4
		1/2
11	1/2	1/4
		1/2
12	1/4	1/4
		1/2
12	3/8	1/4
		1/2
12	1/2	1/4
		1/2
12	5/8	1/4
		1/2
12	3/4	1/4
		1/2
12	1	1/4
		1/2
14	1/2	1/4
		1/2
14	3/4	1/4
		1/2
14	1	1/4
		1/2
16	1/2	1/4
		1/2
16	3/4	1/4
		1/2
16	1	1/4
		1/2
18	1/2	1/4
		1/2
18	1	1/4
		1/2
20	1/2	1/4
		1/2
20	3/4	1/4
		1/2
20	1	1/4
		1/2
24	3/4	1/4
		1/2
24	1	1/4
		1/2
30	1	1/4
		1/2

STANDARD PACKAGE = 1 WHEEL

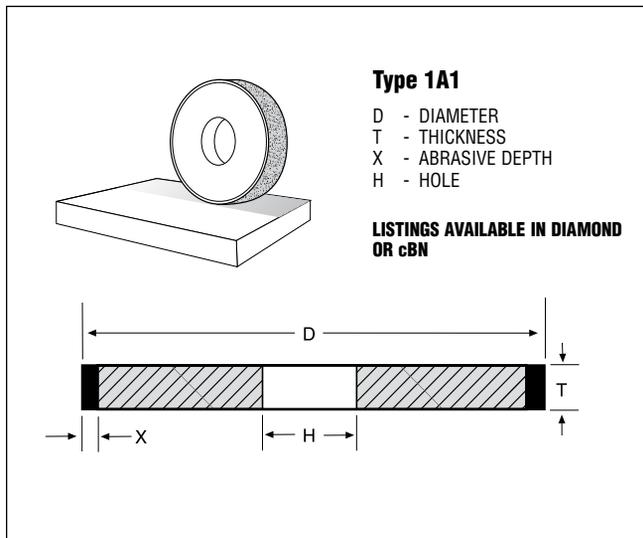

# NORTON B99 EXPRESS MADE-TO-ORDER RESIN PRODUCTS

BLUEPRINT NUMBER	D	T	MINIMUM H	E	X	X1
<b>TYPE 1A1R – CUT-OFF WHEELS</b>						
ME43571	3	1/32	1/2	.022	1/4	3/16
ME93308	3	.035	1/2	.027	1/4	3/16
ME87950	4	.025	1/2	.017	1/8	3/32
ME77202	4	.031	1/2	.022	1/8	3/32
ME43570	4	1/32	1/2	.022	1/4	3/16
ME81257	4	.035	1/2	.027	1/8	3/32
ME86670	4	.035	1/2	.027	1/4	3/16
ME65456	4	1/16	1/2	.052	1/4	3/16
ME81104	5	.018	1/2	.015	1/8	3/32
ME80798	5	.025	1/2	.020	1/8	3/32
ME79842	5	.035	1/2	.030	1/8	3/32
ME76331	5	.040	1/2	.035	1/8	3/32
ME89529	5	1/16	1/2	.057	1/8	3/32
ME100815	5	1/8	1/2	.117	1/8	3/32
ME97801	6	.0305	1/2	.022	1/8	3/32
ME89709	6	1/32	1/2	.022	1/8	3/32
ME81121	6	1/32	1/2	.022	1/4	3/16
ME83187	6	.035	5/8	.027	1/8	1/16
ME80676	6	.035	1/2	.027	1/8	3/32
ME43572	6	.035	1/2	.027	1/4	3/16
ME73316	6	.035	1/2	.027	9/32	1/4
ME72577	6	.040	1/2	.032	1/4	3/16
ME83991	6	.045	1/2	.037	1/8	3/32
ME72002	6	.045	1/2	.037	1/4	3/16
ME74626	6	.050	1/2	.042	1/4	3/16
ME82694	6	.062	1/2	.054	1/8	3/32
ME69777	6	.062	1/2	.054	1/4	3/16
ME93344	6	.125	1/2	.117	1/8	3/32
ME82347	7	.035	1/2	.030	1/4	3/16
ME70075	7	.040	1/2	.030	1/4	3/16
ME75148	8	.035	5/8	.027	9/32	1/4
ME73768	8	.040	5/8	.027	1/4	3/16
ME106550	8	.045	5/8	.032	3/16	1/8
ME102293	8	.045	5/8	.027	1/4	3/16
ME43569	8	.045	5/8	.032	1/4	3/16
ME118534	8	.045	5/8	.032	5/16	1/4
ME43565	10	.050	5/8	.036	1/4	3/16
ME85766	10	1/16	5/8	.041	1/4	3/16
ME43567	12	.070	5/8	.056	1/4	3/16
ME106589	14	.070	3/4	.056	1/4	3/16

**X1 = USABLE ABRASIVE DEPTH**  
**STANDARD PACKAGE = 1 WHEEL**

D	T	H
<b>TYPE 1A8 – ID WHEELS</b>		
1/4	1/8	1/8
5/16	1/4	1/8
3/8	1/32	1/8
3/8	1/4	1/8
3/8	3/8	1/8
3/8	1/2	1/8
3/8	1/2	3/16
7/16	3/8	1/8
7/16	1/2	1/8
1/2	1/4	1/8
1/2	1/4	1/4
1/2	3/8	1/8
1/2	1/2	1/8
1/2	1/2	3/16
1/2	1/2	1/4
1/2	5/8	1/4
9/16	1/2	1/4
9/16	3/4	1/4

D	T	H
<b>TYPE 1A8 – ID WHEELS (CONT'D)</b>		
5/8	1/4	1/4
5/8	3/8	1/4
5/8	1/2	3/16
5/8	1/2	1/4
5/8	5/8	1/4
5/8	3/4	1/4
3/4	1/32	3/16
3/4	1/16	1/8
3/4	1/4	1/4
3/4	3/8	1/4
3/4	1/2	1/4
3/4	3/4	1/4
7/8	1/2	1/4
7/8	5/8	1/4
1	1/16	1/4
1	1/4	1/4
1	1/2	1/4

**STANDARD PACKAGE = 1 WHEEL**

**CONTINUED**

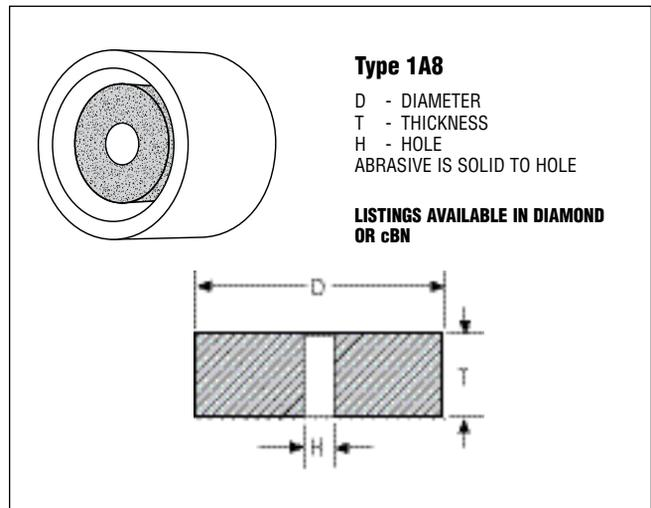
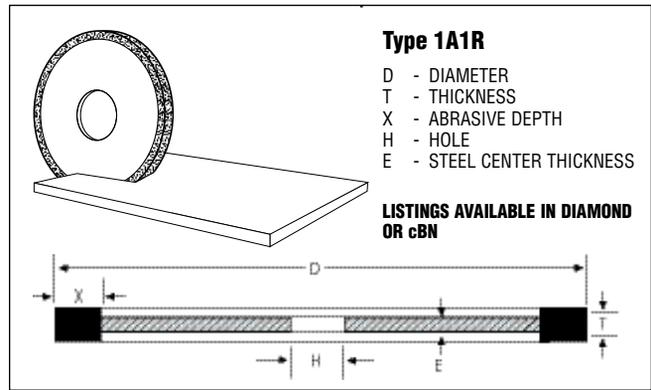

# NORTON B99 EXPRESS MADE-TO-ORDER RESIN PRODUCTS

D	T	V	X
<b>TYPE 1B1</b>			
3	1/16	5° - 45°	1/8
3	1/16	5° - 71°	1/4
3	3/32	5° - 63°	1/8
4	1/16	5° - 45°	1/8
4	1/16	5° - 71°	1/4
4	3/32	5° - 33°	1/8
4	3/32	5° - 63°	1/4
6	1/16	5° - 45°	1/8
6	1/16	5° - 71°	1/4
6	3/32	5° - 33°	1/8
6	3/32	5° - 63°	1/4

STANDARD PACKAGE = 1 WHEEL

D	T	V	X
<b>TYPE 1E1</b>			
3	3/32	74° & LARGER	1/8
4	1/16	53° & LARGER	1/8
4	1/8	90° & LARGER	1/8
6	1/16	53° & LARGER	1/8
6	3/32	74° & LARGER	1/8
6	1/8	90° & LARGER	1/8

STANDARD PACKAGE = 1 WHEEL

D	T	V	X
<b>TYPE 1EE1</b>			
3	1/8	60°	1/8
3	1/8	70°	1/8
3	1/8	90°	1/8
3	3/16	60°	1/8
3	3/16	90°	1/8
3	1/4	60°	1/8
3	1/4	70°	1/8
3	1/4	90°	1/8
3	1/4	60°	1/4
3	1/2	90°	1/8
4	1/8	30°	1/8
4	1/8	45°	1/8
4	1/8	50°	1/8
4	1/8	60°	1/8
4	1/8	70°	1/8
4	1/8	90°	1/8
4	1/8	120°	1/8
4	1/4	45°	1/8
4	1/4	60°	1/8
4	1/4	70°	1/8
4	1/4	90°	1/8
4	1/4	60°	1/4
4	3/8	90°	1/8
4	3/8	120°	1/8
4	3/8	90°	1/4
4	3/4	45°	1/8
4	3/4	60°	1/8
5	1/8	45°	1/8
5	1/8	90°	1/8
5	3/8	90°	1/8
5	3/8	90°	1/4
6	1/8	60°	1/8
6	1/8	70°	1/8
6	1/8	90°	1/8
6	1/4	30°	1/8
6	1/4	45°	1/8
6	1/4	60°	1/8
6	1/4	70°	1/8
6	1/4	90°	1/8
6	1/4	60°	1/4
6	1/4	90°	1/4
6	3/8	30°	1/8
6	3/8	60°	1/8
6	3/8	90°	1/8
6	1/2	60°	1/8
6	1/2	90°	1/8
6	3/4	90°	1/8
7	1/8	60°	1/8
7	1/8	90°	1/8
7	1/4	45°	1/8
7	1/4	60°	1/8
7	1/4	70°	1/8
7	1/4	90°	1/8
7	3/8	60°	1/8
7	3/8	90°	1/8
7	3/8	120°	1/8
7	1/2	60°	1/8
7	1/2	90°	1/8
7	1/2	100°	1/8

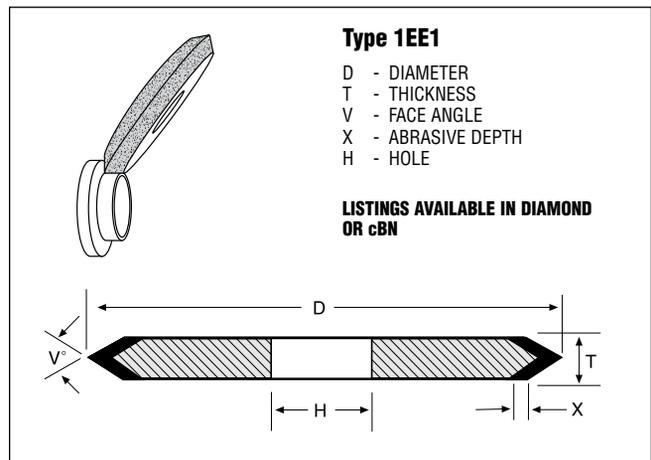
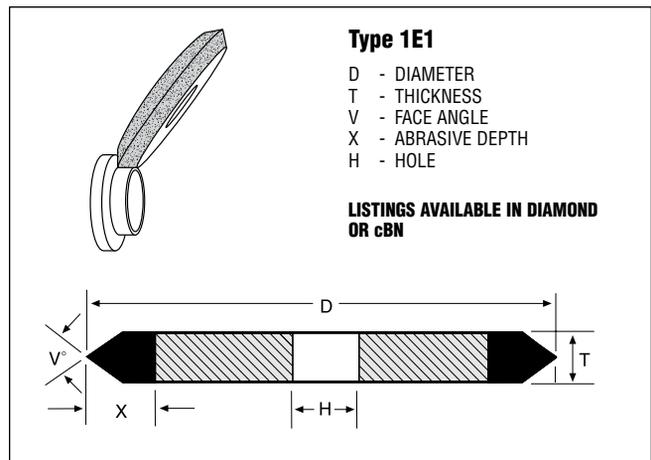
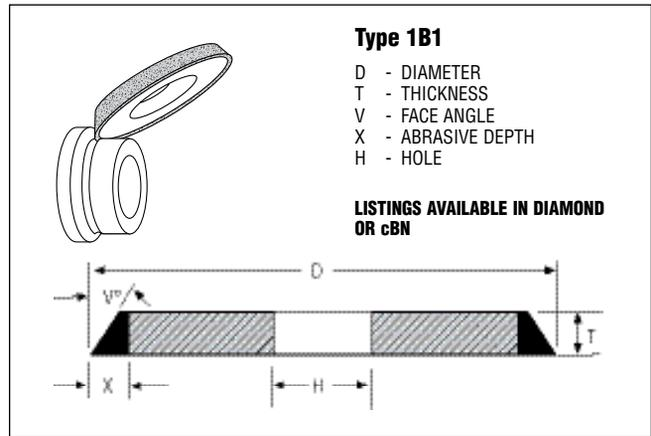

CUSTOMER TO SPECIFY HOLE SIZE, SUBJECT TO SAFETY STANDARDS.

D	T	MIN. R	X
<b>TYPE 1F1 – RADIUS WHEELS</b>			
3	1/16	1/32	1/8 1/4
3	3/32	3/64	1/8 1/4
4	1/16	1/32	1/8 1/4
4	3/32	3/64	1/8 1/4
4	1/8	1/16	1/8 1/4
4	3/16	3/32	1/8 1/4
5	1/16	1/32	1/8 1/4
5	3/32	3/64	1/8 1/4
6	1/16	1/32	1/8 1/4
6	3/32	3/64	1/8 1/4
6	1/8	1/16	1/8 1/4
6	1/4	1/8	1/4

**STANDARD PACKAGE = 1 WHEEL**

D	T	R	X
<b>TYPE 1FF1 – RADIUS WHEELS</b>			
3	1/8	1/16	1/8
3	1/4	1/8	1/8
3	3/16	3/32	1/8
3	3/8	3/16	1/8
3	1/2	1/4	1/8
4	1/8	1/16	1/8
4	5/32	5/64	1/8
4	3/16	3/32	1/8
4	7/32	7/64	1/8
4	1/4	1/8	1/8 1/4
4	5/16	5/32	1/8
4	3/8	3/16	1/8
4	1/2	1/4	1/8
5	1/8	1/16	1/8
5	3/16	3/32	1/8
5	1/4	1/8	1/8

**CONTINUED**

D	T	R	X
<b>TYPE 1FF1 – RADIUS WHEELS (CONT'D)</b>			
6	1/8	1/16	1/8
6	5/32	5/64	1/8
6	3/16	3/32	1/8 1/4
6	1/4	1/8	1/8
6	5/16	5/32	1/4
6	3/8	3/16	1/8
6	1/2	1/4	1/8
6	5/8	5/16	1/8
7	1/8	1/16	1/8
7	3/16	3/32	1/8
7	1/4	1/8	1/8
7	3/8	3/16	1/8
7	1/2	1/4	1/8

**STANDARD PACKAGE = 1 WHEEL**

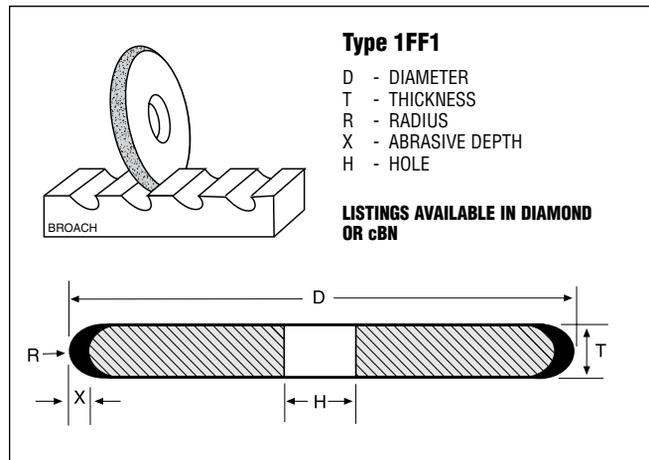
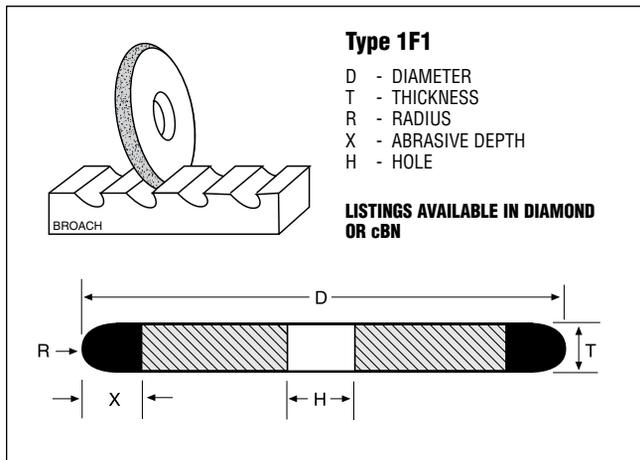

**CUSTOMER TO SPECIFY HOLE SIZE, SUBJECT TO SAFETY STANDARDS.**

# NORTON B99 EXPRESS MADE-TO-ORDER RESIN PRODUCTS

D	T	V	X
<b>TYPE 1V1</b>			
2	1/8	20°	1/8
2	1/8	30°	1/8
2	1/8	45°	1/8
2	1/4	30°	1/8
2	1/4	45°	1/8
3	1/8	15°	1/8
3	1/8	30°	1/8
3	1/8	45°	1/8
3	1/8	60°	1/8
3	1/8	30°	1/4
3	1/8	45°	1/4
3	1/4	20°	1/8
3	1/4	30°	1/8
3	1/4	45°	1/8
4	1/8	15°	1/8
4	1/8	20°	1/8
4	1/8	30°	1/8
4	1/8	45°	1/8
4	1/8	15°	1/4
4	3/16	15°	1/8
4	3/16	20°	1/8
4	3/16	30°	1/8
4	3/16	45°	1/8
4	1/4	15°	1/8
4	1/4	20°	1/8
4	1/4	25°	1/8
4	1/4	30°	1/8
4	1/4	45°	1/8
4	1/4	15°	1/4
4	3/8	15°	1/8
4	3/8	20°	1/8
4	3/8	25°	1/8
4	3/8	30°	1/8
4	3/8	45°	1/8
4	1/2	15°	1/8
4	1/2	30°	1/8
4	1/2	45°	1/8
5	1/8	45°	1/8
5	3/16	45°	1/8
5	1/4	30°	1/8

CONTINUED

D	T	V	X
<b>TYPE 1V1 (CONTD)</b>			
5	1/4	15°	1/4
5	1/4	25°	1/4
5	1/4	30°	1/4
5	3/8	15°	1/4
6	1/8	45°	1/8
6	1/8	15°	1/4
6	1/8	20°	1/4
6	1/8	30°	1/4
6	1/8	45°	1/4
6	3/16	30°	1/8
6	3/16	45°	1/8
6	3/16	15°	1/4
6	1/4	15°	1/8
6	1/4	25°	1/8
6	1/4	30°	1/8
6	1/4	45°	1/8
6	1/4	15°	1/4
6	1/4	30°	1/4
6	1/4	45°	1/4
6	5/16	15°	1/8
6	5/16	12°	1/4
6	3/8	45°	1/8
6	3/8	10°	1/4
6	3/8	20°	1/4
6	3/8	30°	1/4
6	1/2	20°	1/8
6	1/2	45°	1/8
7	1/8	60°	1/8
7	1/4	10°	1/8
7	1/4	20°	1/8
7	1/4	30°	1/8
7	1/4	45°	1/8
7	3/8	10°	1/8
7	3/8	20°	1/8
7	3/8	45°	1/8
7	1/2	25°	1/8
7	1/2	30°	1/8
7	1/2	35°	1/8
7	1/2	45°	1/8

STANDARD PACKAGE = 1 WHEEL

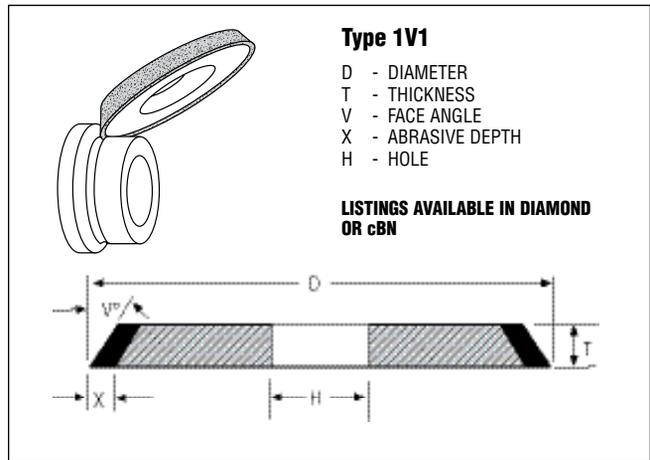

**CUSTOMER TO SPECIFY HOLE SIZE, SUBJECT TO SAFETY STANDARDS.**

**REMEMBER TO CHECK NORTON STOCK AND NORTON/WINTER STOCK AVAILABILITY FIRST, FOR THE FASTEST DELIVERY AND LOWEST PRICE.**



BLUEPRINT		D	T	H	W	N	B.C.	TH'D	X
<b>TYPE 2A2T – RING WHEELS</b>									
C	MC37792	10	13/16 15/16	8	1/4	6	9.000	3/8-16 NC	1/8 1/4
B	ME69812	10	13/16	8	3/8	6	9.000	3/8-16 NC	1/8
B	ME65611	10	7/8 1	8	1/2	6	9.000	3/8-16 NC	1/8 1/4
A	ME39973	10	3/4 7/8	9	1/2	6	9.500	1/4-20 NC	1/8 1/4
B	MC93183	10	3/4	8	3/4	6	9.000	3/8-16 NC	1/8
A	MC35771	10	3/4	8	1	6	9.000	3/8-16 NC	1/8
C	MB91584	11	13/16	9	1/4	6	10.000	3/8-16 NC	1/8
C	MC41891	11	13/16 15/16	9	1/2	6	10.000	3/8-16 NC	1/8 1/4
A	MC45060	11	3/4 7/8	9-1/2	3/4	6	10.250	5/16-18 NC	1/8 1/4
A	MB39846	11	3/4	9	1	6	10.000	3/8-16 NC	1/8
A	MC90807	16	3/4	15	1/2	12	15.500	1/4-20 NC	1/8 1/4
B	MC87885	18	7/8 1	16-9/16	1/4	12	17.250	5/16-18 NC	1/8 1/4
B	ME73188	18	7/8 1	16-1/2	3/8	12	17.250	5/16-18 NC	1/8 1/4
B	MC88985	18	7/8 1	16	1/2	12	17.000	3/8-16 NC	1/8 1/4
A	MC47306	18	7/8 1	16-1/2	3/4	12	17.250	5/16-18 NC	1/8 1/4
A	MC38343	18	3/4 7/8	16	1	12	17.000	3/8-16 NC	1/8 1/4

**NOTE: 2A2T DOES NOT INCLUDE ADAPTER. CONTACT YOUR LOCAL NORTON DISTRIBUTOR FOR PRICE, DELIVERY AND APPLICATION INFORMATION. STANDARD PACKAGE = 1 WHEEL**

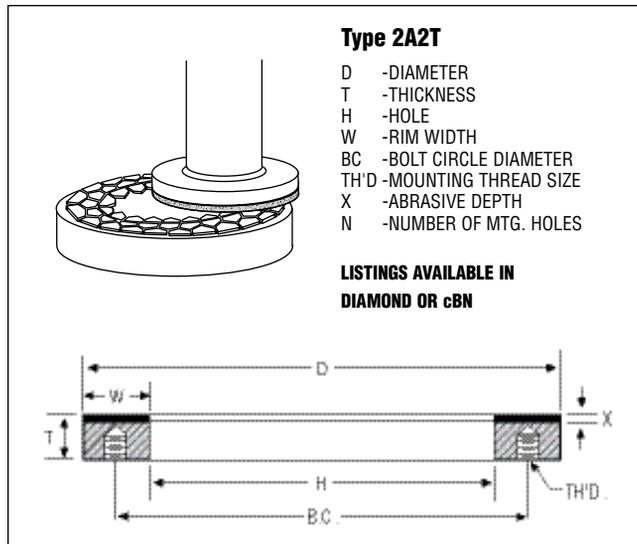
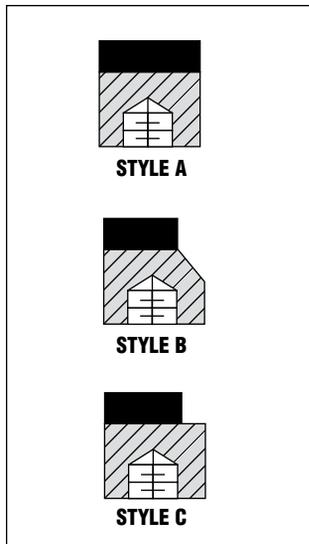

BLUEPRINT NUMBER	D	T	U	J	D2	X
<b>TYPE 3A1 – HUB 1-SIDE WHEELS</b>						
ME114297	3-1/2	1/4	1/8	2-3/4	2-15/16	1/8
ME92383	5	5/16	1/16	3-3/4	4-3/16	1/8
ME66716	5	3/8	1/8	3-3/4	4-3/16	1/8
ME74734	6	1/4	1/8	5-1/16	5-1/4	1/8
ME60795	6	3/8	1/8	5	5-1/2	1/8
ME87172	6	3/8	1/16	4-13/16	5-7/16	1/8
ME87805	6	3/8	1/32	4-15/16	5-5/8	1/8
ME128352	12-1/4	3/8	3/16	11-3/4	—	1/8

STANDARD PACKAGE = 1 WHEEL

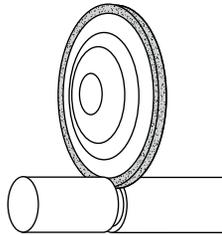

### Type 3A1

- D - DIAMETER
- T - THICKNESS
- H - HOLE
- U - ABRASIVE THICKNESS
- J - HUB DIAMETER
- D2 - LARGE HUB DIAMETER
- X - ABRASIVE DEPTH

LISTINGS AVAILABLE IN DIAMOND OR cBN

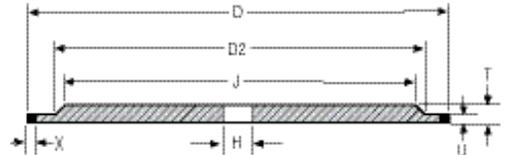

### Type 3A1 – Specific Blueprints

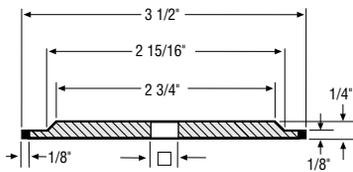

ME114297

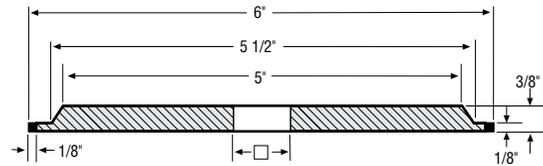

ME60795

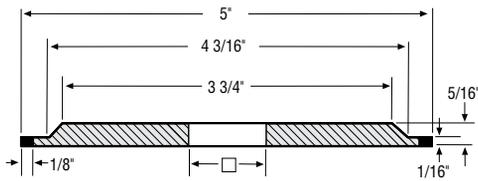

ME92383

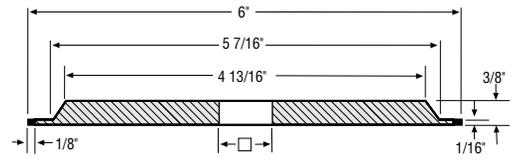

ME87172

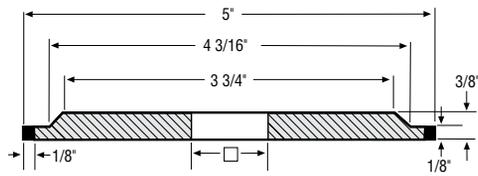

ME66716

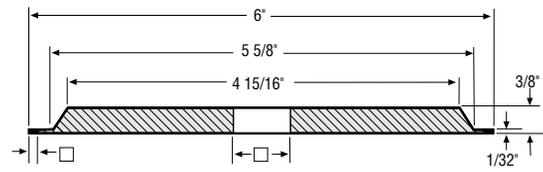

ME87805

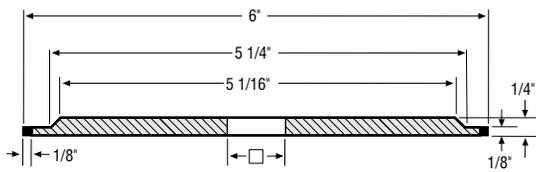

ME74734

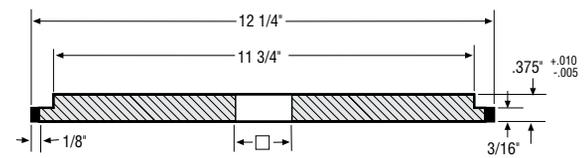

ME128352

VARIABLE

CUSTOMER TO SPECIFY HOLE SIZE, SUBJECT TO SAFETY STANDARDS.

BLUEPRINT NUMBER	D	T	W	J	X
<b>TYPE 4A2P – DISH (SAW SHARPENING) WHEELS</b>					
ME84209	6	3/8 7/16	1/8	2-1/4	1/16 1/8
ME80016	6	3/8 7/16	3/16	2-1/4	1/16 1/8
ME94471	6	1/2 9/16	3/16	3-1/2	1/16 1/8
ME105175	6	17/64 21/64	1/4	3	1/16 1/8
ME88369	6	3/8 7/16	1/4	2-1/4	1/16 1/8
ME97016	6	3/8	1/4	3	1/16
ME91942	6	3/8 7/16	1/4	4-1/4	1/16 1/8
ME83387	6	3/8 7/16	3/8	3	1/16 1/8

STANDARD PACKAGE = 1 WHEEL

## Type 4A2P

- D - DIAMETER
- T - THICKNESS
- H - HOLE
- J - HUB DIAMETER
- W - RIM WIDTH
- X - ABRASIVE DEPTH

LISTINGS AVAILABLE IN  
DIAMOND OR cBN

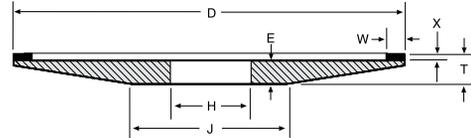
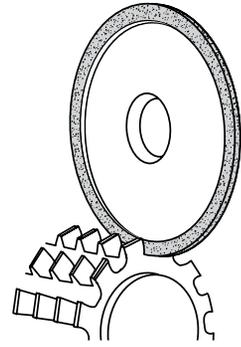

## Type 4A2P – Specific Blueprints

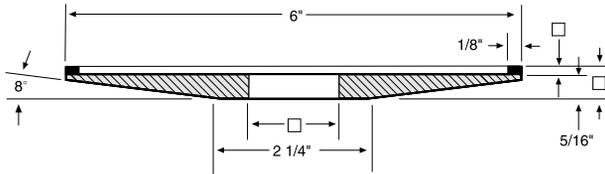

ME84209

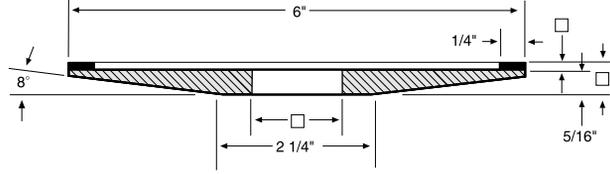

ME88369

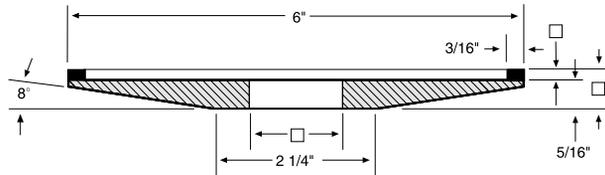

ME80016

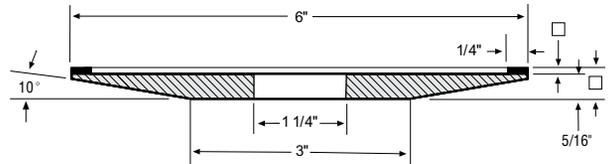

ME97016

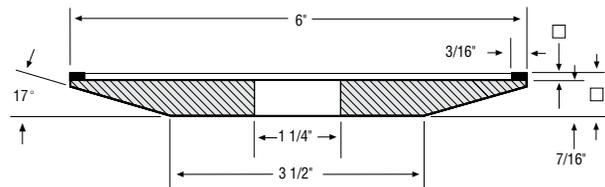

ME94471

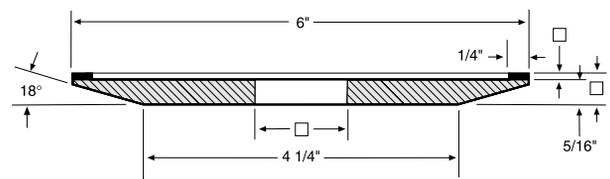

ME91942

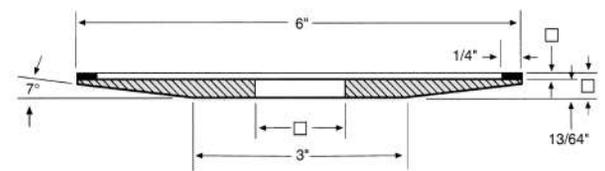

ME105175

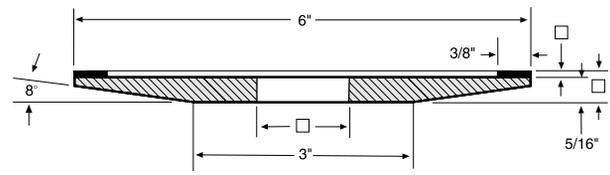

ME83387

VARIABLE

BLUEPRINT NUMBER	D	T	F	V	X
<b>TYPE 4Y1</b>					
ME35789	6	1/8	1/16	45°	1/8
ME65953	6	1/4	1/8	30°	1/8
ME54623	6	1/4	1/8	45°	1/8
ME54649	6	3/8	3/16	45°	1/8
ME38936	6	1/2	1/4	45°	1/8
ME98975	6	1/2	1/4	45°	1/8
ME57664	7	1/4	1/8	45°	1/8
ME68742	7	3/8	3/16	45°	1/8

STANDARD PACKAGE = 1 WHEEL

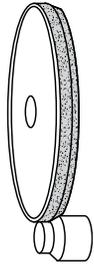

### Type 4Y1

- D - DIAMETER
- T - THICKNESS
- H - HOLE
- V - FACE ANGLE
- F - ABRASIVE FLAT
- X - ABRASIVE DEPTH

LISTINGS AVAILABLE IN DIAMOND OR cBN

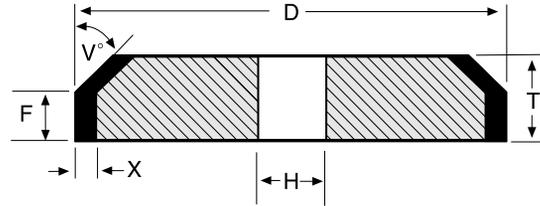

### Type 4Y1 – Specific Blueprints

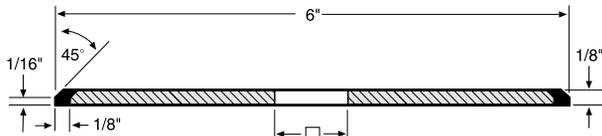

ME35789

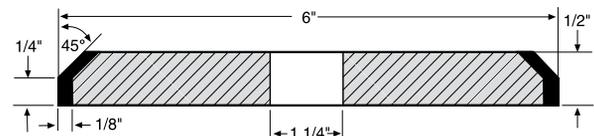

ME38936

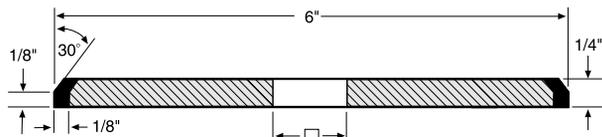

ME65953

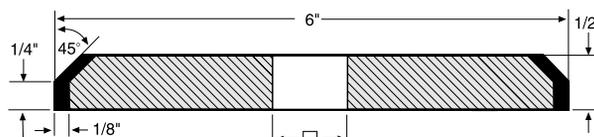

ME98975

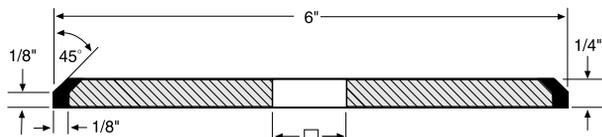

ME54623

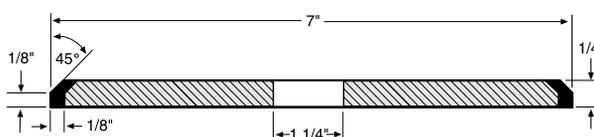

ME57664

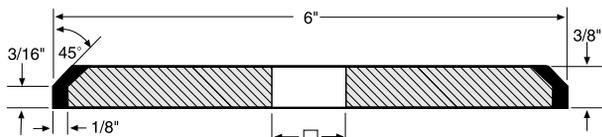

ME54649

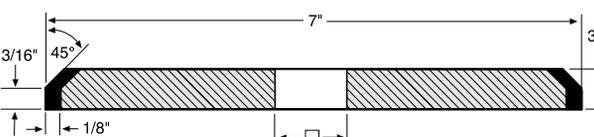

ME68742

VARIABLE

BLUEPRINT NUMBER	D	T	W	E	X
<b>TYPE 6A2 – STRAIGHT CUP WHEELS</b>					
ME156751	2	1/2 9/16	1/2	1/4	1/16 1/8
ME156752	3	3/4 13/16	3/8	3/8	1/16 1/8
ME156755	4	3/4 13/16	1/4	3/8	1/16 1/8
ME156756	4	3/4 13/16	3/8	3/8	1/16 1/8
ME156754	4	3/4 13/16	1/2	3/8	1/16 1/8
ME156757	5	3/4 13/16	3/8	3/8	1/16 1/8
ME156758	6	9/16 5/8	1/4	3/8	1/16 1/8
ME156763	6	3/4 13/16	1/8	3/8	1/16 1/8
ME156761	6	3/4 13/16	3/16	3/8	1/16 1/8
ME156764	6	3/4 13/16	1/4	3/8	1/16 1/8
ME156759	6	3/4 13/16	3/8	3/8	1/16 1/8
ME156762	6	3/4 13/16	1/2	3/8	1/16 1/8
ME156760	6	3/4 13/16	3/4	3/8	1/16 1/8
ME156765	6	3/4 13/16	1	3/8	1/16 1/8
ME156766	6	1.575 1.637	1/2	5/8	1/16 1/8
ME156767	7	3/4 13/16	1/2	3/8	1/16 1/8
ME156768	8	3/4 13/16	3/4	3/8	1/16 1/8
ME156769	10	15/16 1	1	1/2	1/16 1/8

**STANDARD PACKAGE = 1 WHEEL**

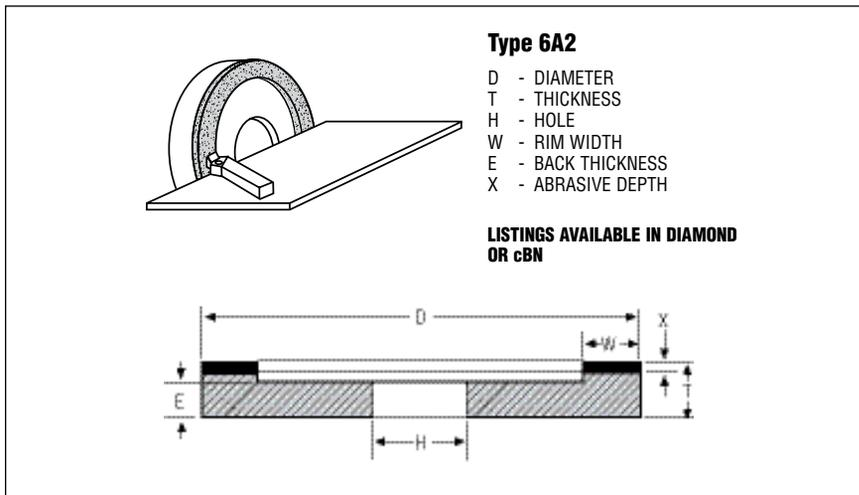

**CUSTOMER TO SPECIFY HOLE SIZE, SUBJECT TO SAFETY STANDARDS.**

BLUEPRINT NUMBER	D	T	W	N	D	E	B.C.	X
<b>TYPE 6A2C – STRAIGHT CUP WHEELS WITH MOUNTING HOLES</b>								
ME36743	6	3/4 13/16	1/4	4	9/32	7/16	3-1/4	1/16 1/8
ME27852	6	3/4 13/16 13/16	3/8	4	9/32	7/16	3-1/4	1/16 1/8 1/4
ME30621	6	3/4 13/16 13/16	1/2	4	9/32	7/16	3-1/4	1/16 1/8 1/4
ME27853	6	3/4 13/16 13/16	3/4	4	9/32	7/16	3-1/4	1/16 1/8 1/4
ME27854	6	3/4 13/16	1	4	9/32	7/16	3-1/4	1/16 1/8
ME54263	7	1-1/4 1-5/16	1	4	9/32	1/2	1-7/8	1/16 1/8
ME34522	10	1 1-1/16	3/4	6	11/32	3/4	3-1/2	1/16 1/8
ME34647	10	1 1-1/16	1	6	11/32	3/4	3-1/2	1/16 1/8

**STANDARD PACKAGE = 1 WHEEL**

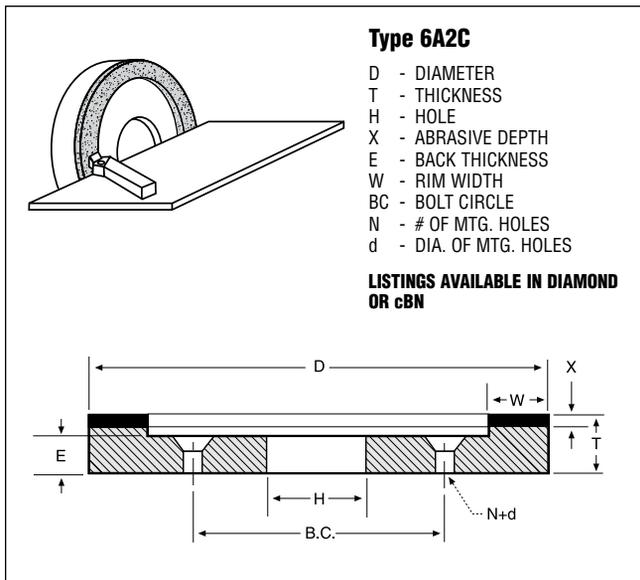

**SEE SPECIFIC TYPE 6A2C BLUEPRINTS ON THE FOLLOWING PAGE.**

**NORTON OFFERS A COMPREHENSIVE STOCK PRODUCT SELECTION TO SERVICE MOST OF YOUR NEEDS – WITH THE FASTEST DELIVERY AND LOWEST PRICES. SEE THESE CATALOG SECTIONS FIRST:**

- Norton Stock B99 Products
- Norton/Winter Stock Toolroom Products

**Can't find the specification in the above sections?**

Then refer to this B99 Express Made-to-Order Resin Product section.

**If a product can not be found in the B99 Express offering:**

Contact your Norton sales representative or distributor for a custom-made product recommendation.

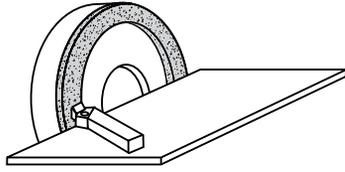

**Type 6A2C**

- D - DIAMETER
- T - THICKNESS
- H - HOLE
- X - ABRASIVE DEPTH
- E - BACK THICKNESS
- W - RIM WIDTH
- BC - BOLT CIRCLE
- N - # OF MTG. HOLES
- D - DIA. OF MTG. HOLES

**LISTINGS AVAILABLE IN DIAMOND OR cBN**

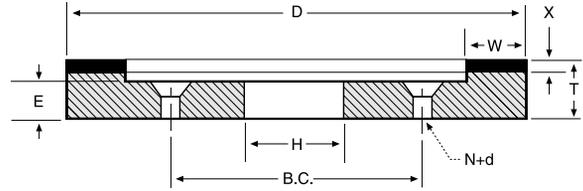

**Type 6A2C – Specific Blueprints (Continued)**

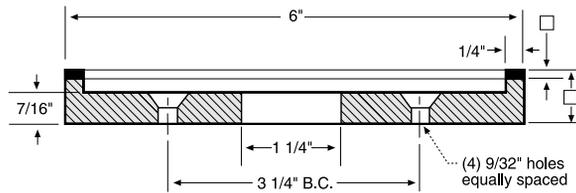

**ME36743**

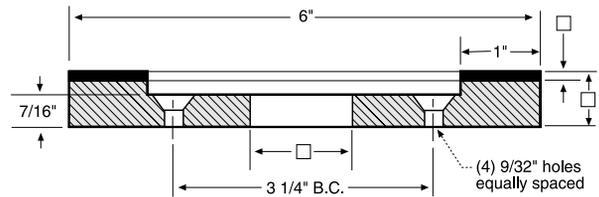

**ME27854**

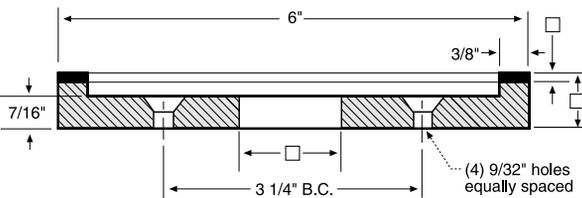

**ME27852**

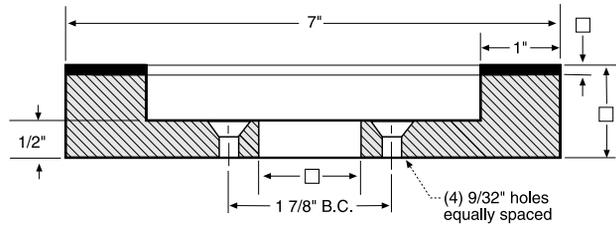

**ME54263**

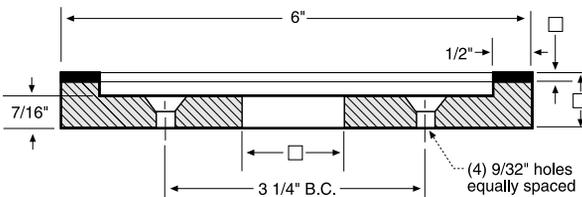

**ME30621**

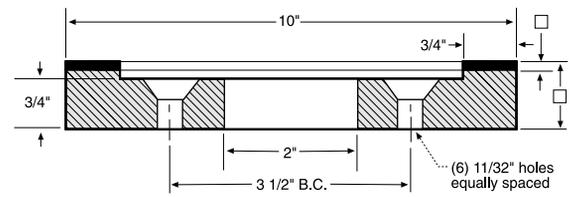

**ME34522**

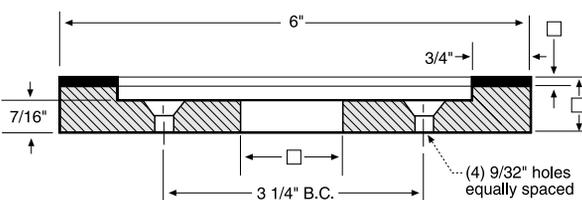

**ME27853**

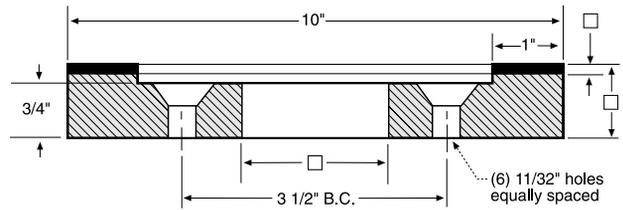

**ME34647**

VARIABLE

**CUSTOMER TO SPECIFY HOLE SIZE, SUBJECT TO SAFETY STANDARDS.**

BLUEPRINT NUMBER	D	T	U	E	K	X
<b>TYPE 6A9 – STRAIGHT CUP WHEELS</b>						
ME57851	3	1-1/2	1/2	3/8	2-1/2	1/16 1/8
ME59701	4	1-1/4	3/8	1/2	3	1/16 1/8
ME57805	5	1-1/2	7/16	1/2	4-1/4	1/16 1/8
ME41681	6	1-1/2	7/16	1/2	5-1/16	1/16 1/8
ME100028	8	2	1/2	3/4	7-1/4	1/8
ME106885	12	1-3/8	1/4	1-1/16	11-1/8	3/16

**STANDARD PACKAGE = 1 WHEEL**

**Type 6A9**

- D - DIAMETER
- T - THICKNESS
- H - HOLE
- E - BACK THICKNESS
- U - INSERT LENGTH
- K - INSIDE DIAMETER
- X - ABRASIVE DEPTH

LISTINGS AVAILABLE IN DIAMOND OR cBN

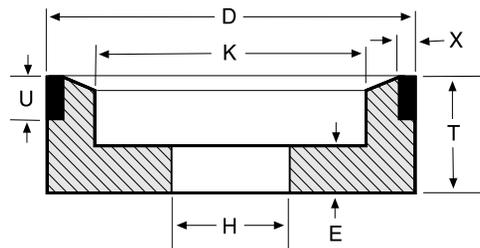

**Type 6A9 – Specific Blueprints**

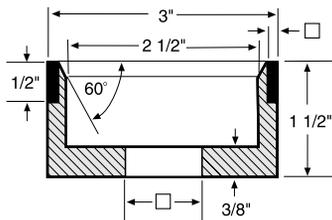

**ME57851**

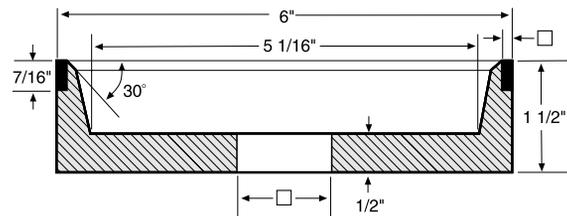

**ME41681**

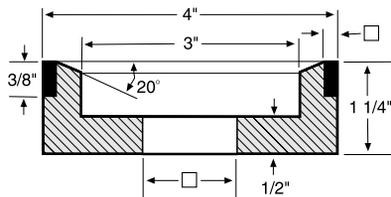

**ME59701**

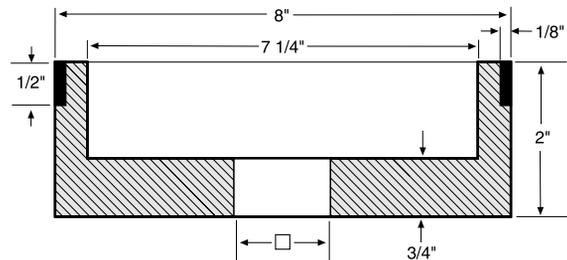

**ME100028**

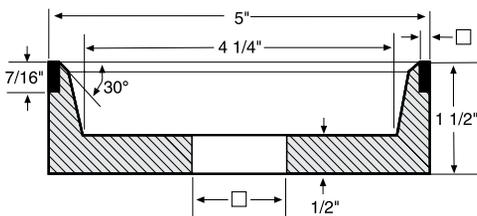

**ME57805**

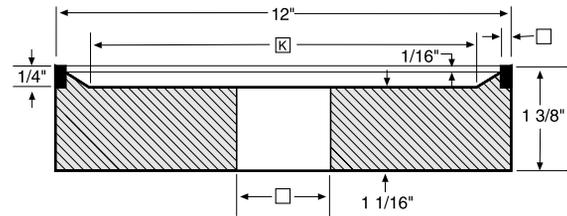

**ME106885**

VARIABLE



BLUEPRINT NUMBER	D	T	W	E	K	X
<b>TYPE 11A2 – CUP WHEELS</b>						
ME26849	3	7/8	3/8	5/16	1-3/4	1/8
ME31815	3	1-5/16	3/8	3/8	1-3/4	1/8
ME28280	3-1/2	1-5/16	3/8	3/8	2-1/4	1/8
ME27793	4	1-1/4	1/2	1/2	2-1/4	1/8
ME33862	5	1-3/4	3/8	1/2	3-1/2	1/8
ME101095	6	1-9/16	3/8	1/2	5-9/64	1/8
		1-11/16				1/4
ME100998	6	1-1/2	1/2	1/2	4-11/16	1/8
		1-5/8				1/4
ME128467	6	1-1/2	1/4	1/2	5-1/32	1/8
					5-3/16	1/4

STANDARD PACKAGE = 1 WHEEL



### Type 11A2

- D - DIAMETER
- T - THICKNESS
- H - HOLE
- E - BACK THICKNESS
- J - HUB DIAMETER

- K - INSIDE DIAMETER OF FLAT
- W - RIM WIDTH
- X - ABRASIVE DEPTH

LISTINGS AVAILABLE IN  
DIAMOND OR cBN

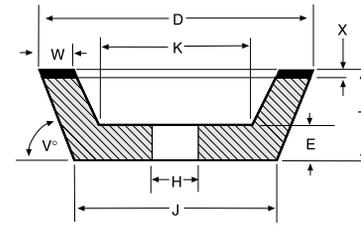

### Type 11A2 – Specific Blueprints

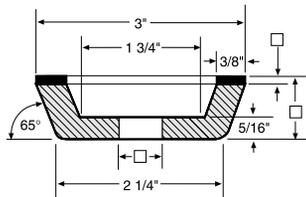

ME26849

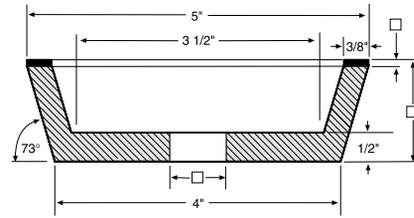

ME33862

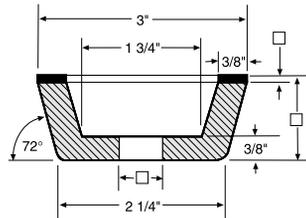

ME31815

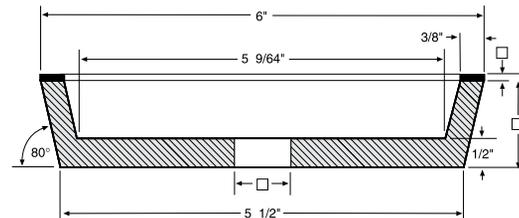

ME101095

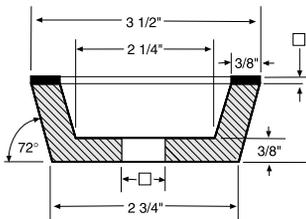

ME28280

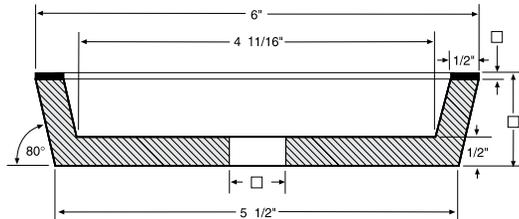

ME100998

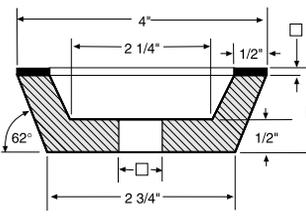

ME27793

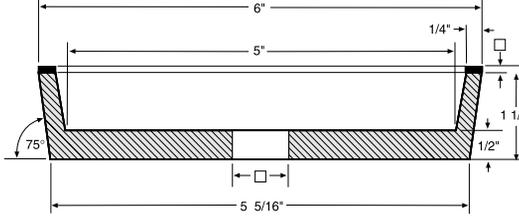

ME128467

VARIABLE

CUSTOMER TO SPECIFY HOLE SIZE, SUBJECT TO SAFETY STANDARDS.

STYLE	BLUEPRINT NUMBER	D	T	S	U	X
<b>TYPE 11V9 – FLARING CUP WHEELS</b>						
B	ME51239*	1	5/8	80°	1/4	1/16 1/8
A	ME88398*	1-1/2	5/8	80°	1/4	1/8
B	ME51238*	1-1/2	5/8	80°	1/4	1/8
B	ME58512*	1-1/2	7/8	70°	1/4	1/16
B	ME89516*	2	5/8	60°	1/4	3/32
B	ME55562*	2	7/8	60°	5/16	1/16 1/8
B	ME42599*	2	1	75°	3/8	1/16 1/8
A	ME93912	3	1-1/4	70°	3/8	1/16 1/8
A	ME92192	3-3/4	1-1/2	70°	3/8	1/16 1/8
A	ME130503	100MM	35MM	70°	6MM	1.5MM 3.0MM
A	ME130500	100MM	35MM	70°	10MM	1.5MM 3.0MM
A	ME130501	125MM	40MM	70°	10MM	1.5MM 3.0MM
A	ME98298	5	1-3/4	70°	7/16	1/16 1/8
A	ME85913	6	1-3/4	70°	1/2	1/16 1/8

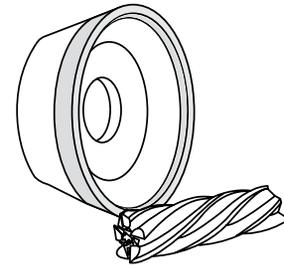

**Type 11V9**

- D - DIAMETER
- T - THICKNESS
- H - HOLE
- E - BACK DIAMETER
- J - HUB DIAMETER
- K - INSIDE DIAMETER OF FLAT
- U - INSERT LENGTH
- S - FACE ANGLE
- X - ABRASIVE DEPTH

**LISTINGS AVAILABLE IN DIAMOND OR cBN**

\*SEE BLUEPRINT FOR MAXIMUM HOLE SIZE. STANDARD PACKAGE = 1 WHEEL

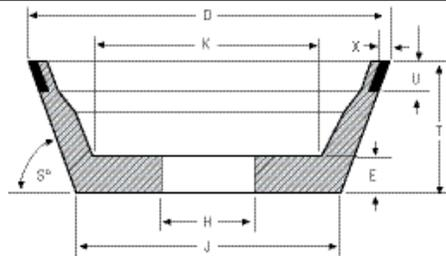

**STYLE A**

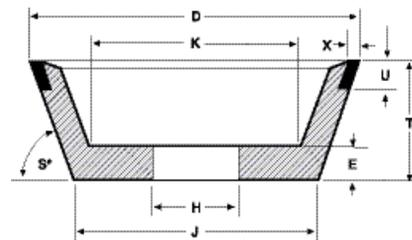

**STYLE B**

**Type 11V9 – Specific Blueprints**

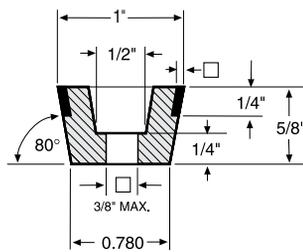

**ME51239**

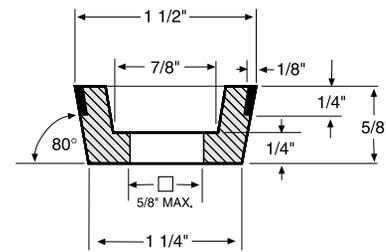

**ME51238**

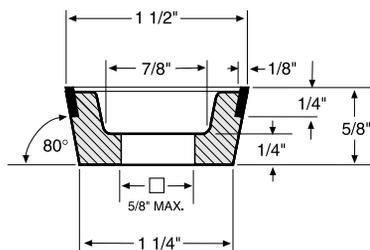

**ME88398**

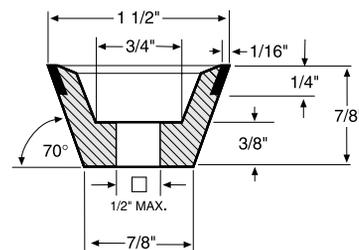

**ME58512**

VARIABLE

**SEE ADDITIONAL TYPE 11V9 BLUEPRINTS ON THE FOLLOWING PAGES.**

**Type 11V9 – Specific Blueprints (continued)**

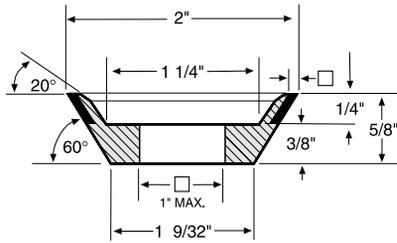

**ME89516**

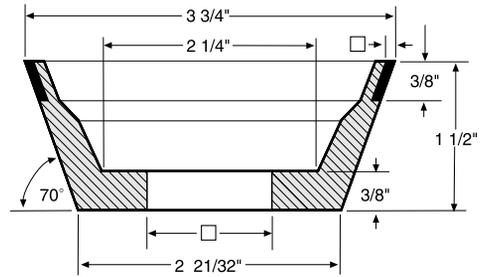

**ME92192**

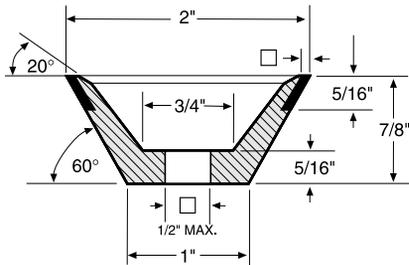

**ME55562**

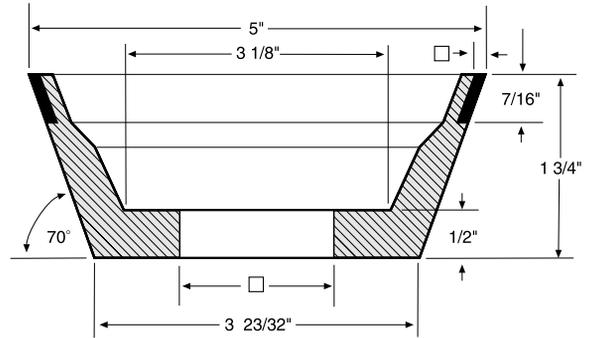

**ME98298**

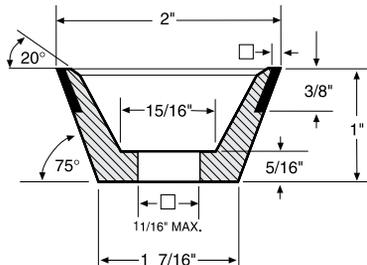

**ME42599**

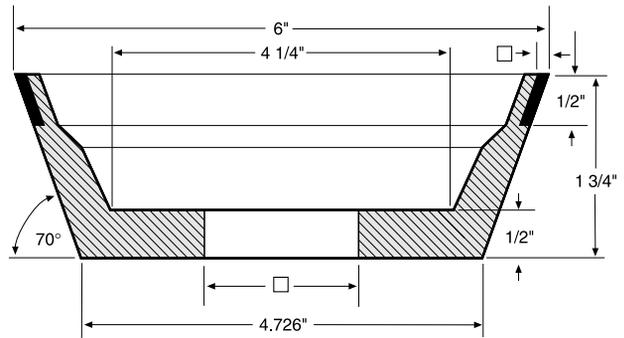

**ME85913**

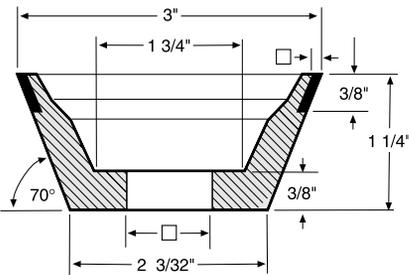

**ME93912**

VARIABLE

**CUSTOMER TO SPECIFY HOLE SIZE, SUBJECT TO SAFETY STANDARDS.**

**Type 11V9 – Specific Blueprints – Metric**

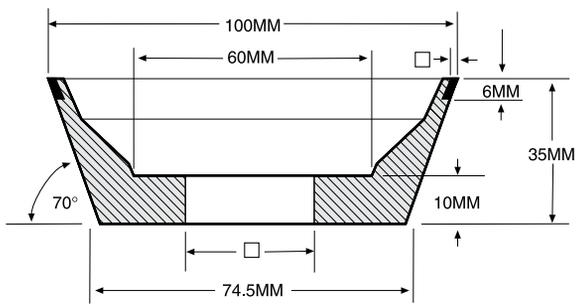

**ME130503**

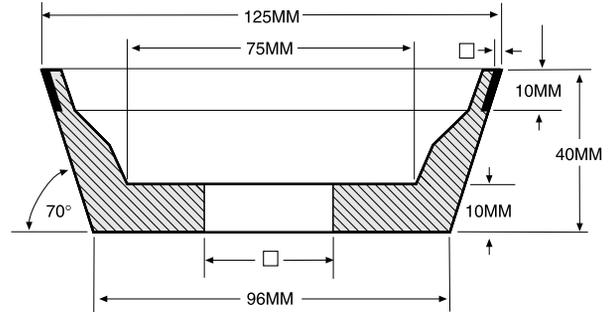

**ME130501**

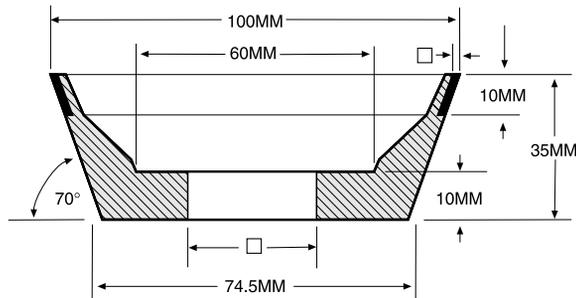

**ME130500**

VARIABLE

BLUEPRINT NUMBER	D	T	W	E	K	X
<b>TYPE 12A2 – DISH WHEELS</b>						
ME40747	3	9/16	1/4	5/16	1-1/2	1/8
ME27757	3	15/16	1/8	3/8	1-1/2	1/8
ME27174*	3	15/16	1/4	3/8	1-1/2	1/8
ME40745	4	9/16	1/4	5/16	2-1/4	1/8
ME40746	4	9/16	3/8	5/16	2-1/4	1/8
ME73686	6	9/16	3/16	5/16	3-1/4	1/8
ME27758	6	1-1/16	3/16	1/2	2-5/8	1/8
ME27175	6	1-1/16	1/4	1/2	2-5/8	1/8
ME33914	6	1-1/16	3/8	1/2	2-5/8	1/8
ME73752	8	1-3/32	3/8	15/16	4-5/8	5/32

\*SEE BLUEPRINT FOR MAXIMUM HOLE SIZE.

STANDARD PACKAGE = 1 WHEEL

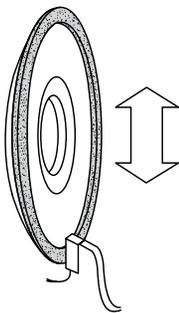

**Type 12A2**

- D - DIAMETER
- T - THICKNESS
- H - HOLE
- E - BACK THICKNESS
- J - HUB DIAMETER
- K - INSIDE DIAMETER OF FLAT
- W - RIM WIDTH
- X - ABRASIVE DEPTH

**LISTINGS AVAILABLE IN  
DIAMOND OR cBN**

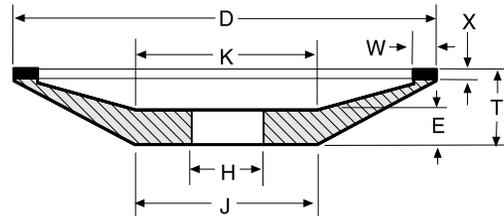

**SEE SPECIFIC TYPE 12A2 BLUEPRINTS ON THE FOLLOWING PAGE.**

**Type 12A2 – Specific Blueprints (continued)**

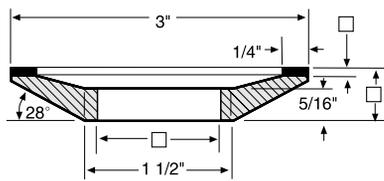

**ME40747**

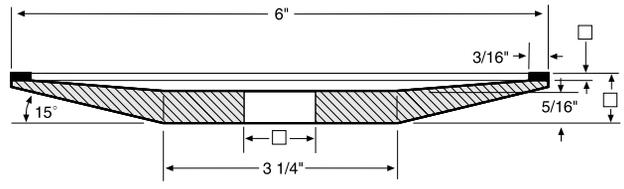

**ME73686**

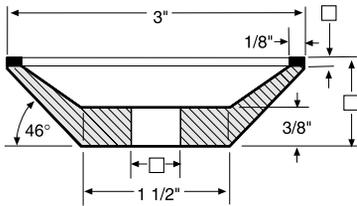

**ME27757**

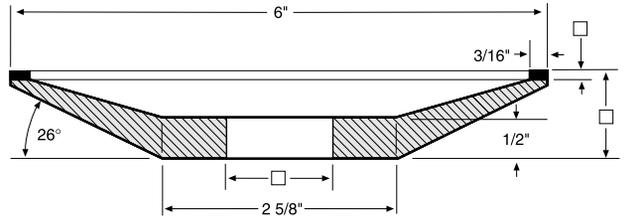

**ME27758**

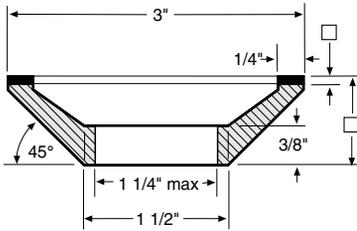

**ME27174**

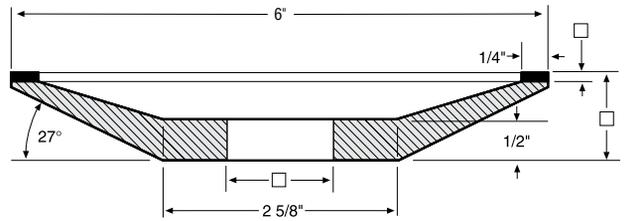

**ME27175**

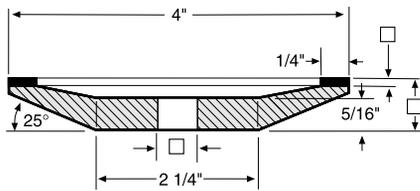

**ME40745**

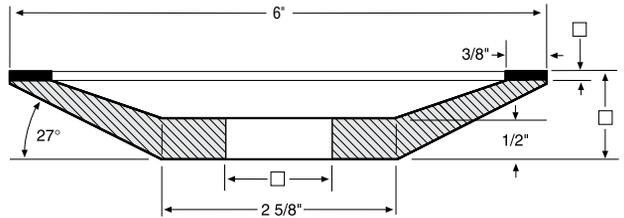

**ME33914**

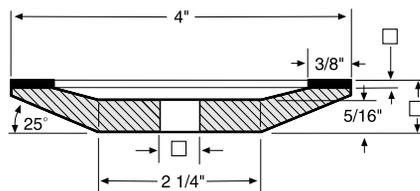

**ME40746**

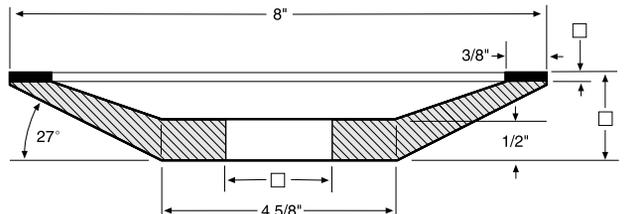

**ME73752**

VARIABLE

**CUSTOMER TO SPECIFY HOLE SIZE, SUBJECT TO SAFETY STANDARDS.**

**REMEMBER TO CHECK NORTON STOCK AND NORTON/WINTER STOCK AVAILABILITY FIRST, FOR THE FASTEST DELIVERY AND LOWEST PRICE.**

BLUEPRINT NUMBER	D	T	E	K	S	U	X
<b>TYPE 12V9 – DISH WHEELS</b>							
ME41755	3	7/16	5/16	1-1/2	30°	7/16	1/16 1/8
ME78406*	3	1/2	1/4	1-1/2	30°	1/4	1/8
ME69978	3	13/16	3/8	1-3/8	45°	11/32	1/16 1/8
ME37191*	3	13/16	3/8	1-3/8	45°	1/2	1/16 1/8
ME58734	4	1/2	1/4	2-1/4	30°	1/4	1/16 1/8
ME80849	4	7/8	3/8	2-1/4	45°	13/32	1/16 1/8
ME120095	5	.709	.394	3-13/32	45°	.394	3/32
ME73312	6	1/2	5/16	4-17/64	30°	3/8	1/16 1/8
ME109758	6	3/4	3/8	2-1/4	25°	1/2	1/16
ME98875	6	3/4	.610	2-1/2	25°	1/2	.148
ME48666	6	3/4	3/8	3-13/32	30°	3/8	1/16 1/8
ME118022	6	1	1/2	3-1/32	30°	1/2	1/16 1/8
ME44377	6	1	1/2	4	45°	3/8	1/8
ME54386	6	1-1/2	3/8	3	45°	17/32	1/16

\*SEE BLUEPRINT FOR MAXIMUM HOLE SIZE. STANDARD PACKAGE = 1 WHEEL

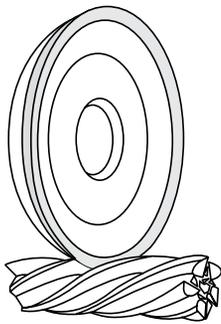

### Type 12V9

- D - DIAMETER
- T - THICKNESS
- H - HOLE
- E - BACK THICKNESS
- J - HUB DIAMETER
- K - INSIDE DIAMETER
- U - INSERT LENGTH
- S - FACE ANGLE
- X - ABRASIVE DEPTH

LISTINGS AVAILABLE IN DIAMOND OR cBN

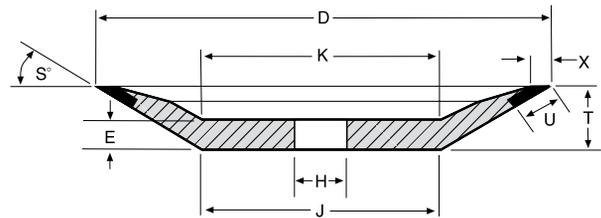

### Type 12V9 – Specific Blueprints

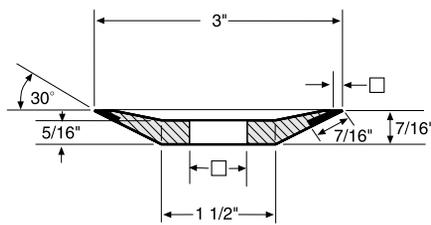

ME41755

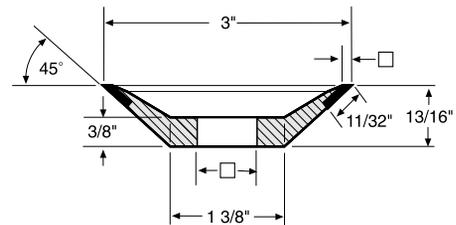

ME69978

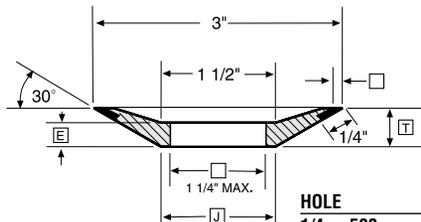

ME78406

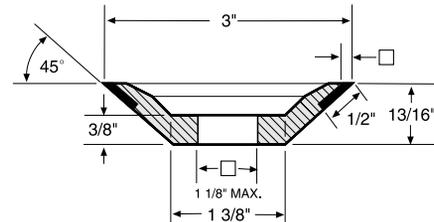

ME37191

VARIABLE

SEE ADDITIONAL SPECIFIC TYPE 12V9 BLUEPRINTS ON THE FOLLOWING PAGE.

**Type 12V9 – Specific Blueprints (Continued)**

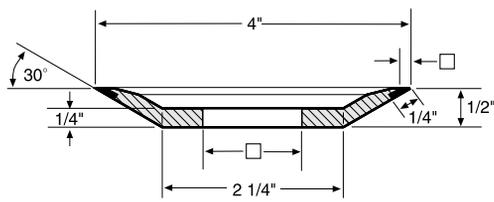

**ME58734**

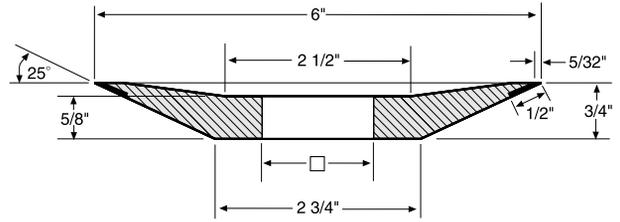

**ME98875**

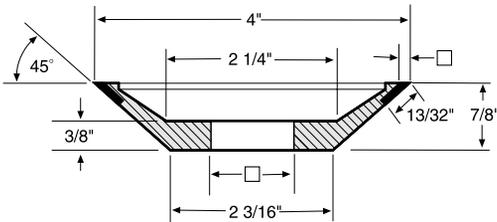

**ME80849**

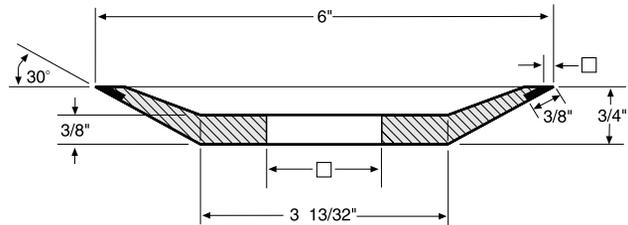

**ME48666**

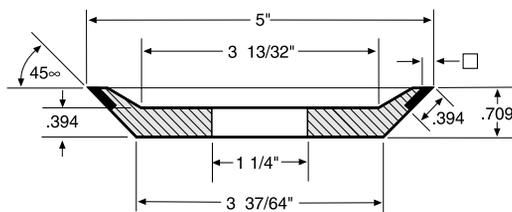

**ME120095**

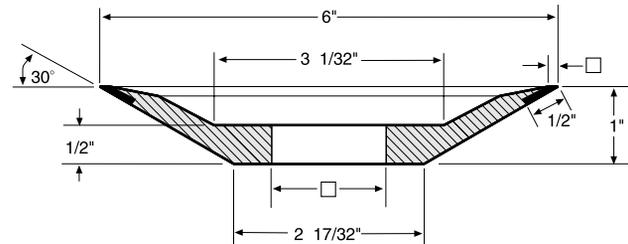

**ME118022**

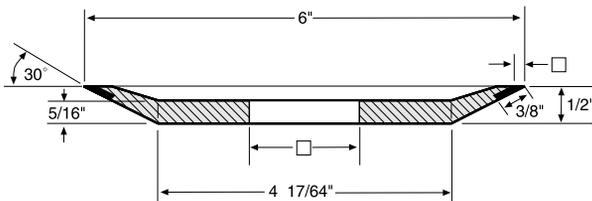

**ME73312**

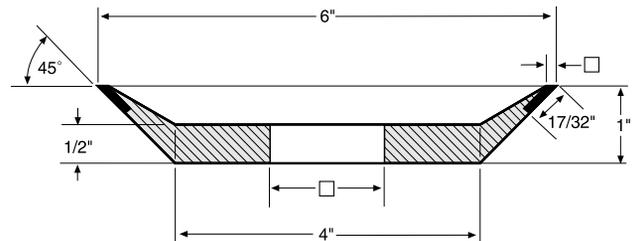

**ME44377**

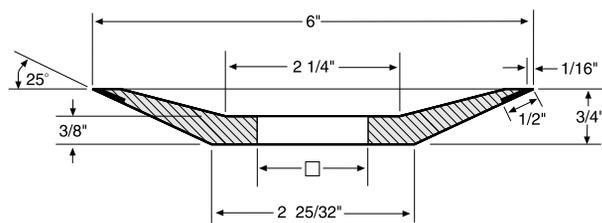

**ME109758**

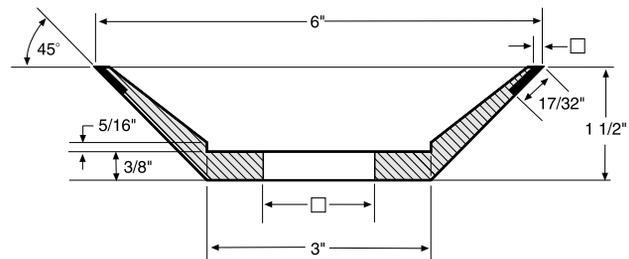

**ME54386**

 **VARIABLE**

**CUSTOMER TO SPECIFY HOLE SIZE, SUBJECT TO SAFETY STANDARDS.**

BLUEPRINT NUMBER	D	T	J	U	X
<b>TYPE 14A1 – HUB 2-SIDES WHEELS</b>					
ME54382	6	1/2	4-15/16	1/16	1/8
ME41276	6	1/2	4	1/8	1/16
ME34745	7	1/2	3-15/16	1/8	1/8
ME41385	10	1/2	7	1/4	1/16
					1/8

STANDARD PACKAGE = 1 WHEEL

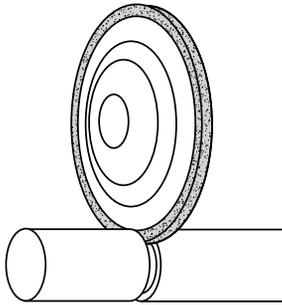

**Type 14A1**

D - DIAMETER  
T - THICKNESS  
H - HOLE  
D2 - LARGE HUB DIAMETER  
X - ABRASIVE DEPTH  
U - ABRASIVE THICKNESS  
J - HUB DIAMETER

LISTINGS AVAILABLE IN DIAMOND OR cBN

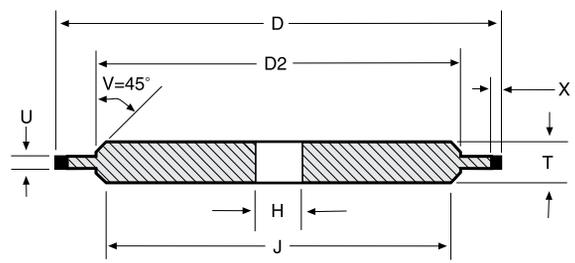

**Type 14A1 – Specific Blueprints**

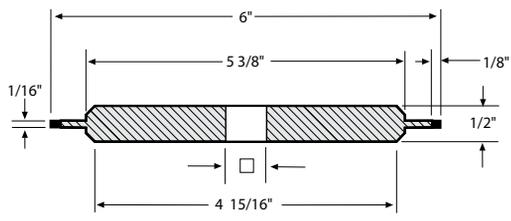

**ME54382**

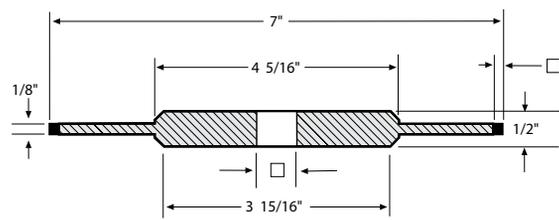

**ME34745**

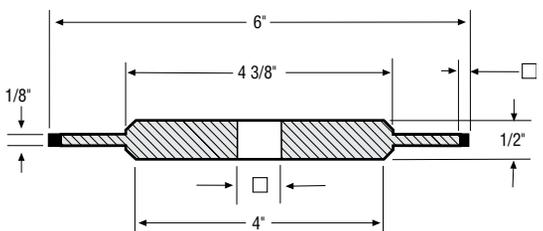

**ME41276**

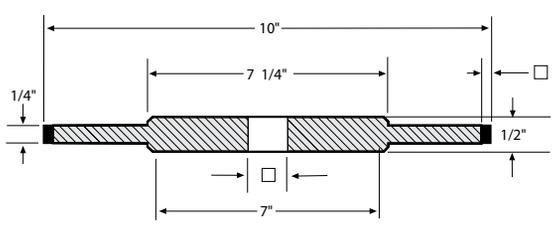

**ME41385**

VARIABLE

REMEMBER TO CHECK NORTON STOCK AND NORTON/WINTER STOCK AVAILABILITY FIRST, FOR THE FASTEST DELIVERY AND LOWEST PRICE.



BLUEPRINT NUMBER	D	T	W	E	K	S	X
<b>TYPE 15A2 – DISH WHEELS</b>							
ME32717	6	13/16	1/8	7/16	3-1/8	45°	1/8
ME32718	6	13/16	3/16	7/16	3-1/8	45°	1/8
ME32719	6	13/16	1/4	7/16	3-1/8	45°	1/8
ME32720	6	13/16	3/8	7/16	3-1/8	45°	1/8

**STANDARD PACKAGE = 1 WHEEL**

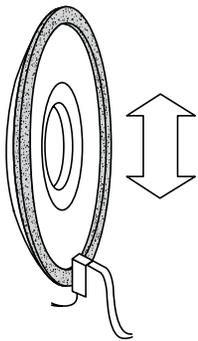

**Type 15A2**

- D - DIAMETER
- T - THICKNESS
- H - HOLE
- X - ABRASIVE DEPTH
- J - HUB DIAMETER
- W - RIM WIDTH
- E - BACK THICKNESS
- K - INSIDE DIAMETER OF FLAT

**LISTINGS AVAILABLE IN DIAMOND OR cBN**

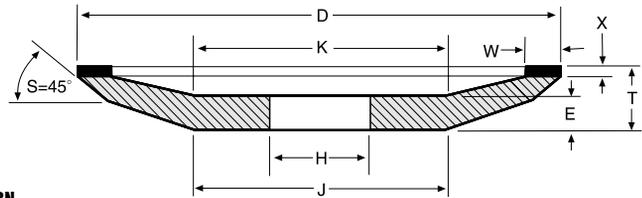

**Type 15A2 – Specific Blueprints**

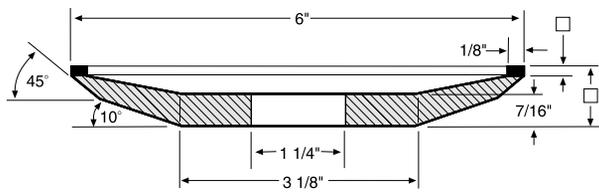

**ME32717**

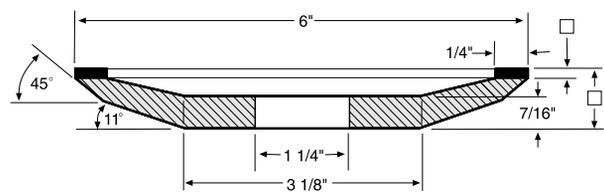

**ME32719**

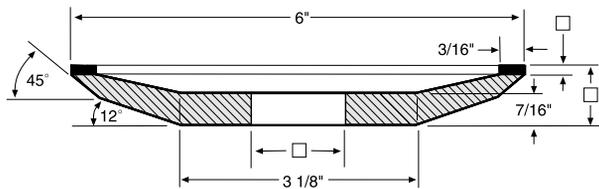

**ME32718**

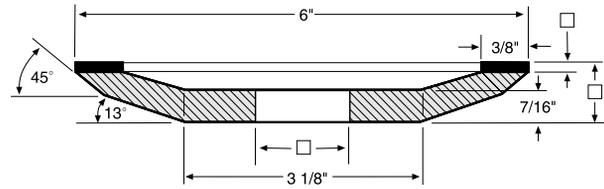

**ME32720**

VARIABLE

**CUSTOMER TO SPECIFY HOLE SIZE, SUBJECT TO SAFETY STANDARDS.**

BLUEPRINT NUMBER	D	T	W	E	K	S	X
<b>TYPE 15V4 – DISH WHEELS</b>							
ME29109	3	15/16	1/8	3/8	1-1/2	30°	1/8
ME40846	6	13/16	1/8	7/16	3-1/8	45°	1/8
ME40847	6	13/16	3/8	7/16	3-1/8	45°	1/8
ME40844	6	1-1/16	1/8	1/2	2-5/8	30°	1/8

**STANDARD PACKAGE = 1 WHEEL**

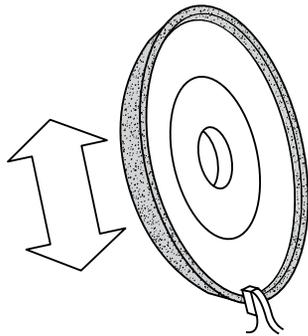

**Type 15V4**

- D - DIAMETER
- T - THICKNESS
- H - HOLE
- E - BACK THICKNESS
- K - INSIDE DIAMETER OF FLAT
- X - ABRASIVE DEPTH
- V - FACE ANGLE = 10°
- W - RIM WIDTH
- J - HUB DIAMETER
- S - BACK ANGLE

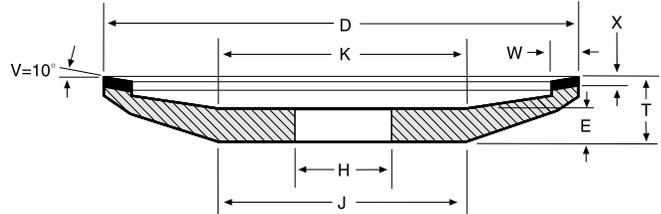

**LISTINGS AVAILABLE IN DIAMOND OR cBN**

**Type 15V4 – Specific Blueprints**

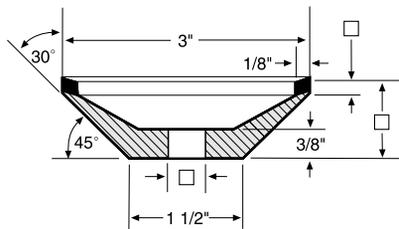

**ME29109**

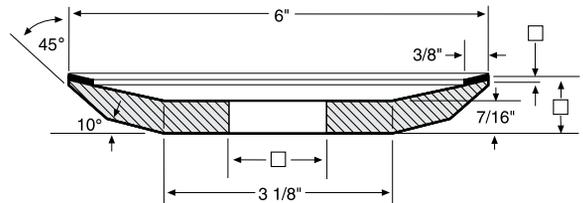

**ME40847**

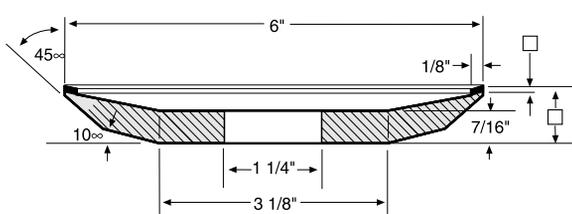

**ME40846**

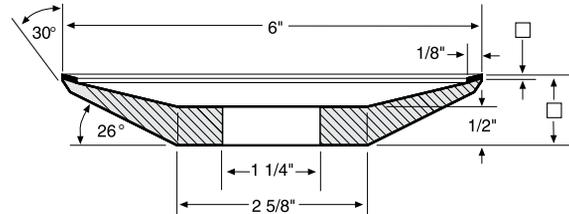

**ME40844**

VARIABLE

**CUSTOMER TO SPECIFY HOLE SIZE, SUBJECT TO SAFETY STANDARDS.**

BLUEPRINT NUMBER	D	T	E	S	U	X
<b>TYPE 15V9 – DISH WHEELS</b>						
ME78452*	2	1/2	5/16	45°	3/16	1/8
ME95738*	2-1/2	1/2	3/8	45°	1/4	1/16
ME70688	3	1/2	1/4	45°	5/16	1/16
						1/8
ME106011	3-1/2	3/4	7/16	45°	3/8	1/16
ME109735	4	1/2	5/16	45°	9/32	1/16
						1/8
ME54577	4	3/4	7/16	45°	9/32	1/16
						1/8
ME68744	5	3/4	7/16	45°	9/32	1/8
ME52205	5	1-3/8	1/2	45°	1/2	1/16
						1/8
ME75786	6	3/4	3/8	30°	3/8	1/16
						1/8
ME40633	6	3/4	7/16	45°	3/8	1/16
						1/8
ME55489	8	3/4	7/16	45°	3/8	1/16
					13/32	1/8

\*SEE BLUEPRINT FOR MAXIMUM HOLE SIZE.  
STANDARD PACKAGE = 1 WHEEL

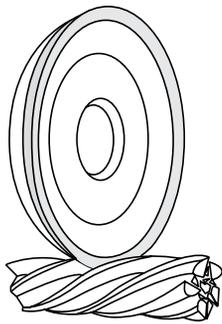

### Type 15V9

- D - DIAMETER
- T - THICKNESS
- H - HOLE
- X - ABRASIVE DEPTH
- E - BACK THICKNESS
- J - HUB DIAMETER
- K - INSIDE DIAMETER
- U - INSERT LENGTH
- S - FACE ANGLE

LISTINGS AVAILABLE IN DIAMOND OR cBN

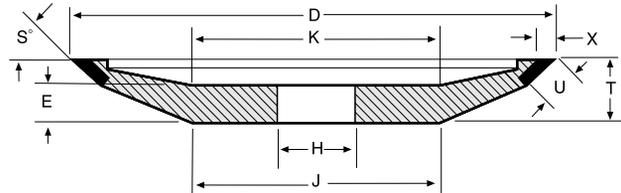

### Type 15V9 – Specific Blueprints

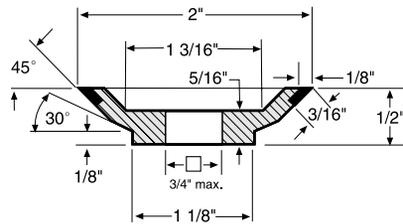

ME78452

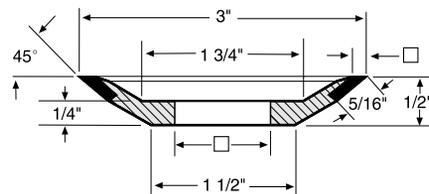

ME70688

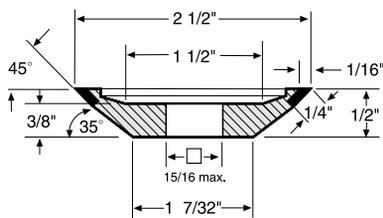

ME95738

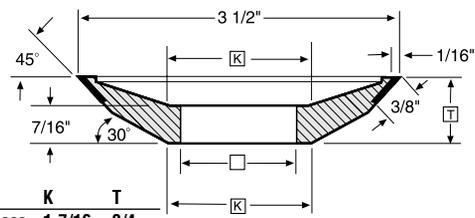

ME106011

HOLE	K	T
1-3/16 or less	1-7/16	3/4
1-1/4	1-1/2	47/64

□ VARIABLE

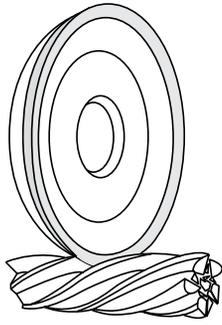

**Type 15V9**

- D - DIAMETER
- T - THICKNESS
- H - HOLE
- X - ABRASIVE DEPTH
- E - BACK THICKNESS
- J - HUB DIAMETER
- K - INSIDE DIAMETER
- U - INSERT LENGTH
- S - FACE ANGLE

**LISTINGS AVAILABLE IN DIAMOND OR cBN**

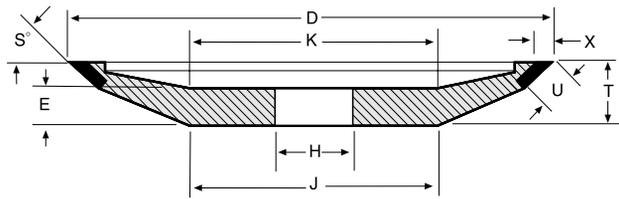

**Type 15V9 – Specific Blueprints**

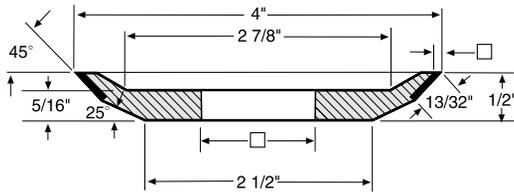

**ME109735**

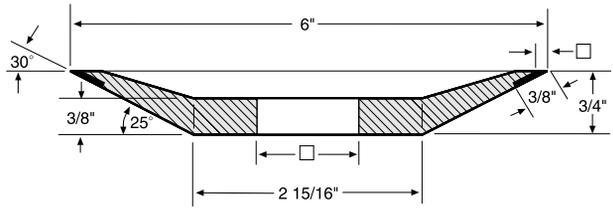

**ME75786**

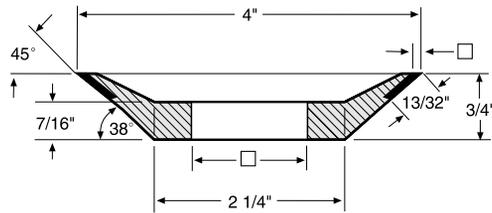

**ME54577**

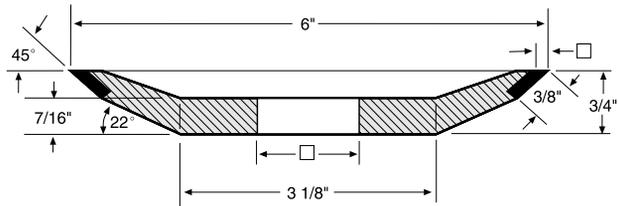

**ME40633**

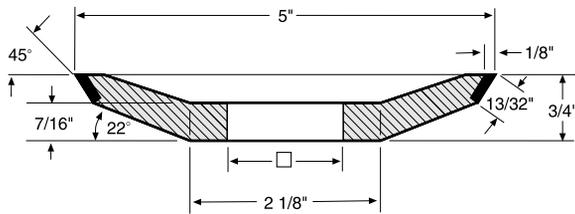

**ME68744**

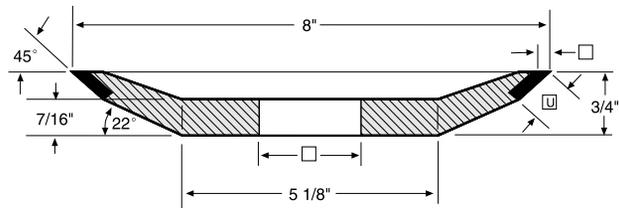

**ME55489**

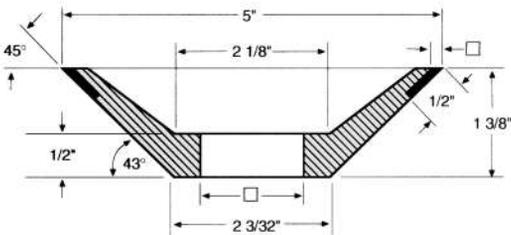

**ME52205**

VARIABLE

**REMEMBER TO CHECK NORTON STOCK AND NORTON/WINTER STOCK AVAILABILITY FIRST, FOR THE FASTEST DELIVERY AND LOWEST PRICE.**



These superior, pre-engineered wheels have been specifically developed to meet the demanding needs of precision cutting tool manufactures as well as re-sharpeners. The use of the highest quality diamond and cBN abrasives matched to superior high temperature bond systems, guarantees high performing wheels. These wheels are manufactured under the strictest quality control protocols ensuring the same, consistent, high-performing product. Cutting tool manufactures who use these wheels report much improved dimensional accuracy and superior cutting edges.

This product offering provides wheel sizes for most CNC machines and wheels shapes to produce the required cutting tool geometries. If you do not find a wheel in this offering to suit your specific needs, a custom-made wheel can be provided.



## TYPICAL APPLICATIONS

- CNC round tool grinding

### BEST

**NORTON PARADIGM DIAMOND WHEELS – FOR CNC WC ROUND TOOL MANUFACTURING**  
**NORTON G-FORCE CBN WHEELS – FOR CNC HSS ROUND TOOL MANUFACTURING**

#### FEATURES

- Truable
- Wear and load resistant
- High grain retention; uniform structure
- Low specific cutting energy

#### BENEFITS

- Online and offline truable for maximum productivity
- Superior grinding on 6% to 12% cobalt
- Better control over core growth
- High G-ratio; up to 2.5 times longer life and 30% higher MRR than existing superabrasive wheels
- Faster grinding with lower power draw and less burn

### BETTER

**NORTON G-FORCE AND POLYIMIDE DIAMOND WHEELS – FOR CNC WC ROUND TOOL MANUFACTURING**

#### FEATURES

#### Univel and G-Force premium products

- Polyimide bond systems

#### BENEFITS

- Superior form-holding and lower-power requirements compared to premium competitive wheels
- Reduced frequency of dresses
- Decreased chances of burn and heat damage to the part

#### G-Force

- Unique bond technology
- Self-dressing
- The only product on the market that is truly rotary dress-able
- Leads the industry in depth of cut, traverse rates and form holding
- Excels on round, carbide and steel tools
- Abrasive is strongly held – and wear-resistant
- Maintains a consistently sharp grinding edge
- Allows for lights-out manufacturing
- Reduces total grinding costs by 30% or more

### GOOD

**NORTON/WINTER AND NORTON CNC WHEELS – FOR SHORT RUNS AND FREQUENT GEOMETRY CHANGES**

#### FEATURES

#### Norton/Winter

- A price competitive alternative to Univel and G-Force

#### BENEFITS

- The product of choice for short-run manufacturing jobs where frequent wheel profile changes are required, and premium wheels can not be cost-justified
- Can be reshaped for numerous short runs
- Great performance/price ratio

#### Norton

- Ideal for resharping and short-run manufacturing operations
- Free cutting phenolic specifications formulated for oil coolants
- Consistent wheel-to-wheel performance
- Precision tolerances
- Competitively-priced while providing premium performance
- Grind with less heat and pressure – eliminating burning
- Reduced cycle times, less dressing = longer wheel life
- Repeatable part geometry

SEE PRODUCT IDENTIFICATION SYSTEM/USAGE INFORMATION ON PAGES 9-10 FOR ADDITIONAL INFORMATION.

DIAMOND CNC WHEELS

		BEST NORTON PARADIGM			BETTER NORTON G-FORCE/UNIVEL			GOOD NORTON/WINTER AND NORTON			
ABR. WIDTH U,W	ANGLE V	SPECIFICATION		ABR. DEPTH X	UPC #	SPECIFICATION		ABR. DEPTH X	UPC #	SPECIFICATION	
<b>TYPE 1A1 – DIAMOND FLUTE</b>											
4 x 1/2 x 1-1/4		SD320-D168-P100C	3/8	07958783055*	AD320-UP061 G-Force	1/4	60157663909	A4D180-R115B610	1/4	69014118200	
								D220-C100-K+925	6mm	60157623605	
5 x 3/8 x 1-1/4		SD320-D168-P100C	1/2	07958783058*	AD320-UP061 G-Force	1/2	60157668409	A4D220-R115B610	1/2	69014118255	
								D220-C100-K+925	6mm	60157625123	
5 x 1/2 x 1-1/4		SD320-C176-P100C	1/2	07958783061	AD320-UP061 G-Force	1/2	60157662240	A4D180-R115B610	1/2	69014118202	
								D220-C100-K+925	6mm	60157613099	
5 x 5/8 x 1-1/4		SD320-C176-P100C	1/2	07958783063*	AD320-UP061 G-Force	1/2	60157663486*	A4D180-R115B610	1/2	69014118203*	
6 x 1/2 x 1-1/4		SD320-C176-P100C	1/2	07958783064	AD320-UP061 G-Force	1/4	60157682133*	A4D180-R115B610	1/4	69014118216*	
								D280-N100K+1421	6mm	60157624551	
<b>TYPE 1A1 – DIAMOND POLISH</b>											
5 x 1/2 x 1-1/4					80D1000-100UP731 Univel	1/2	07958784316*				
<b>TYPE 1A1 – DIAMOND RELIEF</b>											
6 x 1/2 x 1-1/4		SD320-E168-P100C	1/2	07958783073*	AD320-UP892 G-Force	1/2	69014117684*	A4D180-R115B610	1/2	69014118217*	
								D280-N100-K+1421	6mm	60157624551	
<b>TYPE 1A1RN – DIAMOND FLUTE</b>											
5 x 3/8 x 1-1/4		SD320-D168-P100C	1/2	07958783067*	AD320-UP061 G-Force	1/2	60157663501	A4D180-R115B610	1/2	69014118201	
								D220-C100-K+925	6mm	60157625123	
5 x 1/2 x 1-1/4					AD220-UP061 G-Force	1/2	66260322280				
5 x 5/8 x 1-1/4					AD220-UP061 G-Force	1/2	60157664141				
<b>TYPE 1B1 – DIAMOND FLUTE</b>											
4 x 3/8 x 1-1/4	V=20°	SD320-D168-P100C	3/8	07958783054							
<b>TYPE 1B1 – DIAMOND FLUTE/GASH</b>											
5 x 3/8 x 1-1/4	V=45°	SD320-E168-P100C	1/2	07958783065							
<b>TYPE 1B1 – DIAMOND GASH</b>											
5 x 1/2 x 1-1/4	V= 45°	SD320-E168-P100C	1/4	07958783062*							
5 x 1/2 x 1-1/4	V=60°	SD320-E168-P100C	1/4	07958783060*							
5 x 1/2 x 1-1/4	V=30°	SD320-E168-P100C	3/4	07958783070*				A4D320-R115B610	3/4	69014118207	
								D220-C100-K+925	6mm	60157613112	
5 x 1/2 x 1-1/4	V=45°	SD320-E168-P100C	3/4	07958783068*	AD320-UP531 G-Force	3/4	66260329603	A4D320-R115B610	3/4	69014118208	
								D220-C100-K+925	6mm	60157623673	
<b>TYPE 1V1 – DIAMOND FLUTE</b>											
4 x 3/8 x 1-1/4	V=20°				AD320-UP061 G-Force	1/4	66260316591	A4D180-R115B610	1/4	69014118263	
5 x 1/2 x 1-1/4	V=10°	SD320-C176-P100C	1/2	07958783071*	AD320-UP061 G-Force	1/2	66260116723	A4D180-R115B610	1/2	69014118204	
5 x 1/2 x 1-1/4	V=20°	SD320-C176-P100C	1/2	07958783074	AD320-UP061 G-Force	1/2	60157693843	A4D180-R115B610	1/2	69014118205	
								D220-C100-K+925	6mm	60157623953	
5 x 1/2 x 1-1/4	V=30°	SD320-C176-P100C	1/2	07958783085*	AD320-UP671 G-Force	1/2	60157693841	A4D180-R115B610	1/2	69014118206	

\* NON-STOCK: CONTACT YOUR NORTON REPRESENTATIVE FOR CURRENT LEAD-TIMES.  
ALL HOLES (BORES) ARE MACHINED TO (H7) CLASS FIT.

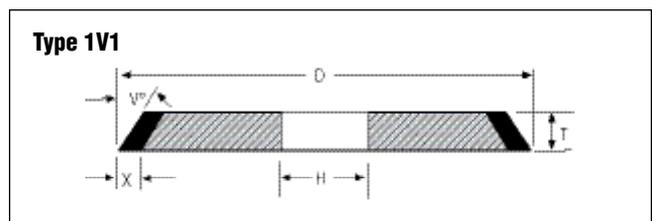
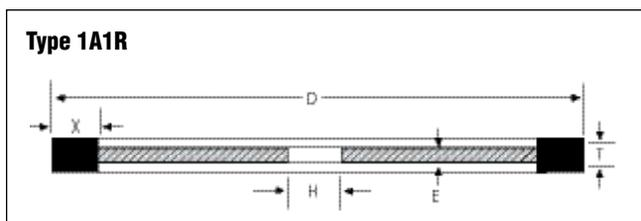
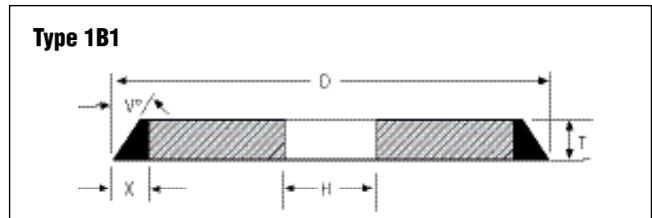
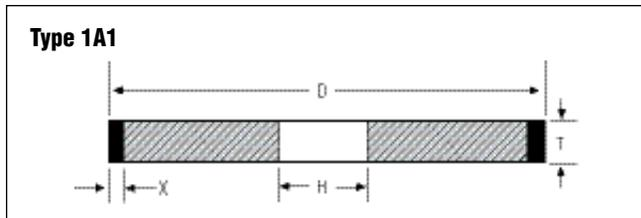

**DIAMOND CNC WHEELS**

		BEST NORTON PARADIGM			BETTER NORTON G-FORCE/UNIVEL			GOOD NORTON/WINTER AND NORTON		
ABR. WIDTH U, W	ANGLE V	SPECIFICATION	ABR. DEPTH X	UPC #	SPECIFICATION	ABR. DEPTH X	UPC #	SPECIFICATION	ABR. DEPTH X	UPC #
<b>TYPE 1V1 – DIAMOND FLUTE/GASH</b>										
5 x 3/8 x 1-1/4	V=45°				AD320-UP531 G-Force	1/2	60157696562	A4D320-R115B610	1/2	69014118257
<b>TYPE 1V1 – DIAMOND GASH</b>										
5 x 1/2 x 1-1/4	V= 45°				AD320-UP531 G-Force	1/4	66260329604	A4D320-R115B610	1/4	69014118209
5 x 1/2 x 1-1/4	V=60°				AD320-UR331 Univel	1/4	66260329469	A4D320-R115B610	1/4	69014118210
<b>TYPE 6A2 – DIAMOND POINT</b>										
4 x 1-1/4 x 1-1/4		SD320-E168-P100C	1/4	07958783057*	AD320-UP251 G-Force	1/4	69014118644*	ASD320C-R100B56	1/4	69014118219*
W=1/4										
<b>TYPE 11A2 – DIAMOND RELIEF</b>										
3 x 1-1/4 x 1-1/4					10D320-NB100U Univel	1/4	60157692199			
W=1/4										
4 x 1-1/4 x 1-1/4		SD320-E168-P100C	1/4	07958783059*	AD320-UP701 G-Force	1/4	60157696315	ASDC320-R100B80	1/4	69014118213
W=1/4										
4 x 1-1/4 x 1-1/4					AD320-UP561 G-Force	1/4	69014118479*	ASDC320-R100B80	1/4	69014118265*
W=1/4										
<b>TYPE 11V5 – DIAMOND RELIEF</b>										
4 x 1-1/4 x 1-1/4	V=30°				AD320-UP561 G-Force	1/4	69014117838	ASDC320-R100B80	1/4	69014118211
W=1/4										
4 x 1-1/4 x 1-1/4	V=10°				AD320-UP561 G-Force	1/4	69014117812	ASDC320-R100B80	1/4	69014118212
W=3/8										
<b>TYPE 11V9 – DIAMOND RELIEF</b>										
3-3/4 x 1-1/2 x 1-1/4					10D240-PB125-U Univel	1/8	66260322134	ASDC320-R100B80	1/8	69014118259
U=3/8										
5 x 1-3/4 x 1-1/4					10D240-PB125-U Univel	1/8	66260118300	ASDC320-R100B80	1/8	69014118215
U=5/8								D280-R100-K+4821	3mm	60157612443
<b>TYPE 12V9 – DIAMOND RELIEF</b>										
4 x 3/4 x 1-1/4					AD320-UP531 G-Force	1/8	66260127950*	ASDC320-R100B80	1/8	69014118221*
U=3/8								D280-R100K+4821	3mm	60157612442
5 x 3/4 x 1-1/4					AD320-UP531 G-Force	1/8	66260127911*	ASDC320-R100B80	1/8	69014118222*
U=1/2										

\* NON-STOCK; CONTACT YOUR NORTON REPRESENTATIVE FOR CURRENT LEAD-TIMES. ALL HOLES (BORES) ARE MACHINED TO (H7) CLASS FIT.

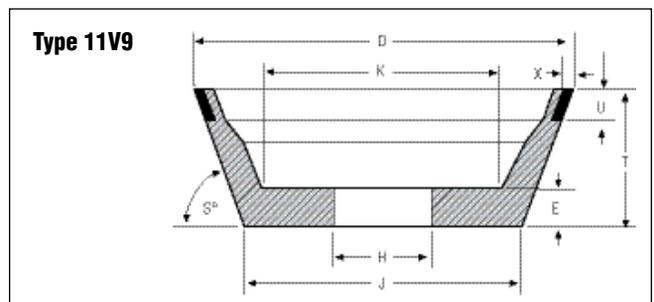
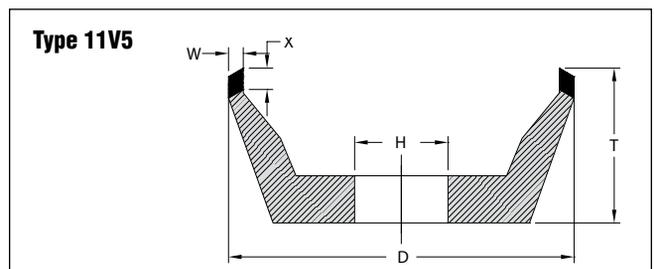
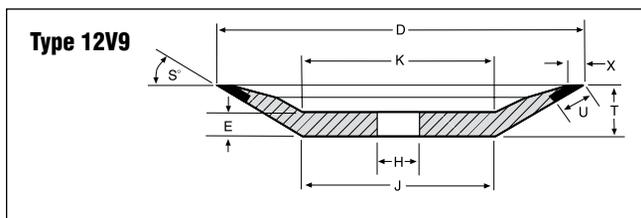
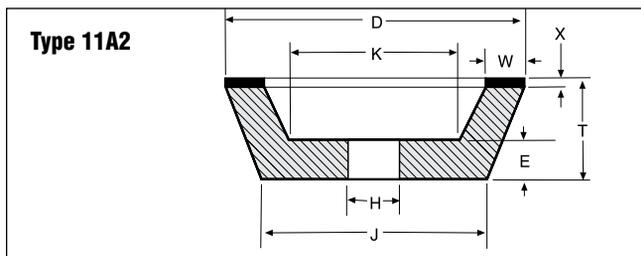
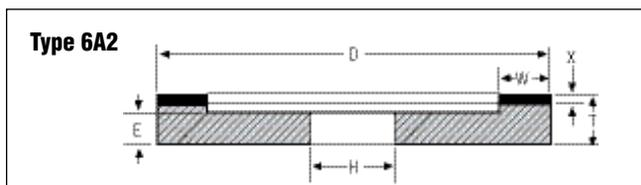



## CBN CNC WHEELS

		BEST NORTON G-FORCE/UNIVEL			GOOD NORTON/WINTER AND NORTON		
ABR. WIDTH U,W	ANGLE V	SPECIFICATION	ABR. DEPTH X	UPC #	SPECIFICATION	ABR. DEPTH X	UPC #
<b>TYPE 1A1 – cBN FLUTE</b>							
4 x 1/2 x 1-1/4		BX220-UP241 G-Force	1/4	60157669935*	BAM180-WBXD3037	1/4	69014118223*
					B220-V240-KSS920	6mm	60157623498
5 x 3/8 x 1-1/4		BX220-UP241 G-Force	1/2	69014118436*	BAM320C-WBXD3037	1/2	69014118256*
5 x 1/2 x 1-1/4		BX220-UP241 G-Force	1/2	60157670869*	BAM180-WBXD3037	1/2	69014118224*
					B220-V240-KSS920	6mm	60157602944
5 x 5/8 x 1-1/4		BX220-UP241 G-Force	1/2	66260329385*	BAM180-WBXD3037	1/2	69014118225*
6 x 1/4 x 1-1/4		BX240-UP241 G-Force	1/4	69014118435*	BAM180-WBXD3037	1/4	69014118240*
<b>TYPE 1A1 – cBN RELIEF</b>							
6 x 1/2 x 1-1/4		BX320-UP892 G-Force	1/2	69014117679*	BAM180-WBXD3037	1/2	69014118237*
<b>TYPE 1A1RN – cBN FLUTE</b>							
5 x 1/4 x 1-1/4		BX150-UP241 G-Force	1/2	07958773216*			
5 x 3/8 x 1-1/4		BX150-UP241 G-Force	1/2	07958773217*			
5 x 1/2 x 1-1/4		BX150-UP241 G-Force	1/2	69014141373*			
<b>TYPE 1B1 – cBN GASH</b>							
5 x 1/2 x 1-1/4	V=30°	BX320-UP701 G-Force	3/4	66260329388*	BAM320C-WBXD3037	3/4	69014118229*
5 x 1/2 x 1-1/4	V=45°	BX320-UP531 G-Force	3/4	66260329391*	BAM320C-WBXD3037	3/4	69014118230*
					B220-V240-KSS920	6mm	60157623542
<b>TYPE 1V1 – cBN FLUTE</b>							
4 x 3/8 x 1-1/4	V=20°	BX220-UP241 G-Force	1/4	69014118342*	BAM180C-WBXD3037	1/4	69014118264*
5 x 1/2 x 1-1/4	V=20°	BX220-UP241 G-Force	1/2	60157680042*	BAM180-WBXD3037	1/2	69014118227*
					B220-V240-KSS920	6mm	60157623944
5 x 1/2 x 1-1/4	V=30°	BX220-UP241 G-Force	1/2	60157691380*	BAM180-WBXD3037	1/2	69014118228*
5 x 1/2 x 1-1/4	V=10°	BX220-UP241 G-Force	1/2	66260119876*	BAM180-WBXD3037	1/2	69014118226*
<b>TYPE 1V1 – cBN FLUTE/GASH</b>							
5 x 3/8 x 1-1/4	V=45°	BX220-UP531 G-Force	1/2	60157697699*	BAM320C-WBXD3037	1/4	69014118262*
					B220-V240-KSS920	6mm	60157623524
<b>TYPE 1V1 – cBN GASH</b>							
5 x 1/2 x 1-1/4	V=60°	BX320-UR331 Univel	1/4	66260329461*	BAM320C-WBXD3037	1/4	69014118232*
5 x 1/2 x 1-1/4	V=45°	BX320-UP531 G-Force	1/4	66260329275*	BAM320C-WBXD3037	1/4	69014118231*
					B220-V240-KSS920	6mm	60157623776
<b>TYPE 6A2 – cBN POINT</b>							
4 x 1-1/4 x 1-1/4		BX320-UP241 G-Force	1/4	69014118543*	CB320C-WBB	1/4	69014118239*
5 X 1-1/4 X 1-1/4		BX320-UP241 G-Force	1/4	69014118447*	CB320C-WBB	1/4	69014118238*

\* NON-STOCK: CONTACT YOUR NORTON REPRESENTATIVE FOR CURRENT LEAD-TIMES.  
ALL HOLES (BORES) ARE MACHINED TO (H7) CLASS FIT.

## TECHtip

### DIAMOND GRINDS:

In general, diamond is used to grind non-ferrous materials, because it reacts with iron.

- Cemented carbide
- Glass
- Ceramics
- Fiberglass
- Plastics
- Stone
- Abrasives
- Electronic components and materials

### cBN GRINDS:

cBN is used to grind ferrous materials.

- High-speed tool steels
- Die steels
- Hardened carbon steels
- Alloy steels
- Aerospace alloys
- Hardened stainless steel
- Abrasion-resistant ferrous materials



It is the user's responsibility to refer to and comply with ANSI B7.1

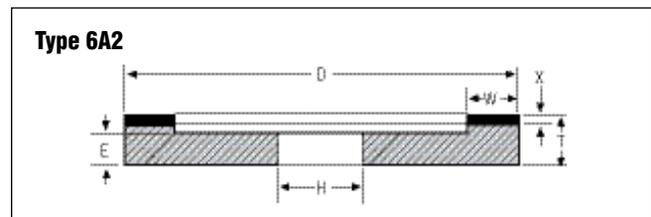
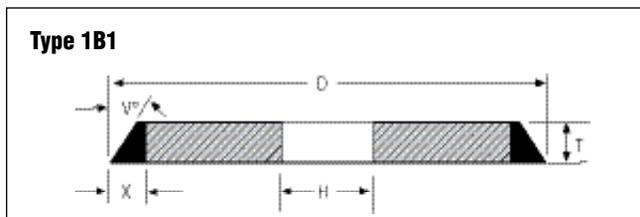
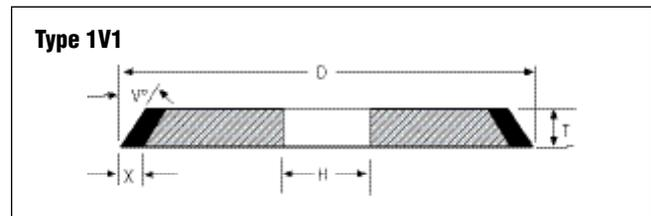
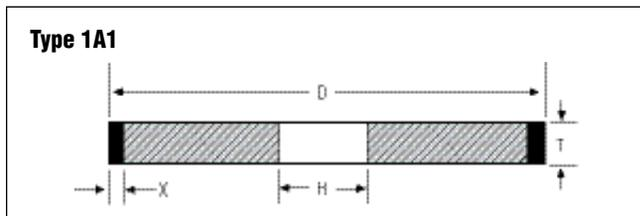

SEE PRODUCT IDENTIFICATION SYSTEM/USAGE INFORMATION ON PAGES 9-10 FOR ADDITIONAL INFORMATION.

## CBN CNC WHEELS

		BEST			GOOD		
		NORTON G-FORCE/UNIVEL			NORTON/WINTER AND NORTON		
ABR. WIDTH U, W	ANGLE V	SPECIFICATION	ABR. DEPTH		SPECIFICATION	ABR. DEPTH	
			X	UPC #		X	UPC #
<b>TYPE 11A2 – cBN RELIEF</b>							
5 x 1-1/2 x 2 W=1/4		BX320-UP531 G-Force	1/4	69014118406*	BAM220-WBE	1/4	69014118254*
<b>TYPE 11A2 – cBN RELIEF</b>							
4 x 1-1/4 x 1-1/4 W=1/4		BX320-UP531 G-Force	1/4	69014118445*	BAM220-WBE	1/4	69014118266*
<b>TYPE 11V5 – cBN RELIEF</b>							
4 x 1-1/4 x 1-1/4 W=1/4 V=30°		BX320-UP701 G-Force	1/4	69014117833*	BAM220-WBE	1/4	69014118233*
4 x 1-1/4 x 1-1/4 W=3/8 V=10°		BX320-UP701 G-Force	1/4	69014117820*	B220-J240-KSS63Y	6mm	60157623563
<b>TYPE 11V9 – cBN RELIEF</b>							
3-3/4 x 1-1/2 x 1-1/4 U=3/8		90B240-PB125-U Univel	1/8	69014118345*	BAM220-WBE	1/8	69014118260*
<b>TYPE 11V9 – cBN RELIEF</b>							
3-3/4 x 1-1/2 x 1-1/4 U=3/8		90B240-PB125-U Univel	1/8	69014118029*	BAM220-WBE	1/8	69014118235*
5 x 1-3/4 x 2 U=3/8		90B240-PB125-U Univel	1/8	69014118043*	BAM220-WBE	1/8	69014118248*
<b>TYPE 12V9 – cBN RELIEF</b>							
4 x 3/4 x 1-1/4 U=3/8		BX320-UP531 G-Force	1/8	69014118470*	BAM220-WBE	1/8	69014118241*
5 x 3/4 x 1-1/4 U=1/2		BX320-UP531 G-Force	1/8	69014118441*	BAM220-WBE	1/8	69014118242*

\* NON-STOCK: CONTACT YOUR NORTON REPRESENTATIVE FOR CURRENT LEAD-TIMES.  
ALL HOLES (BORES) ARE MACHINED TO (H7) CLASS FIT.

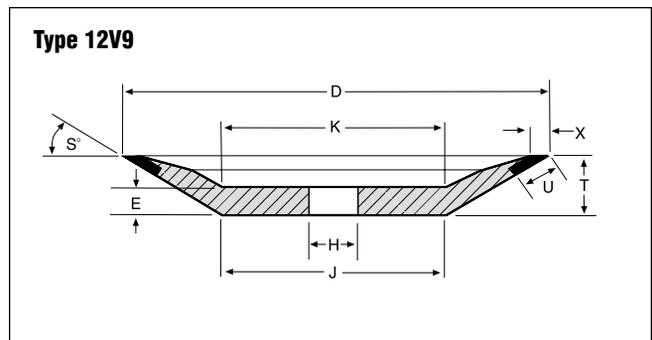
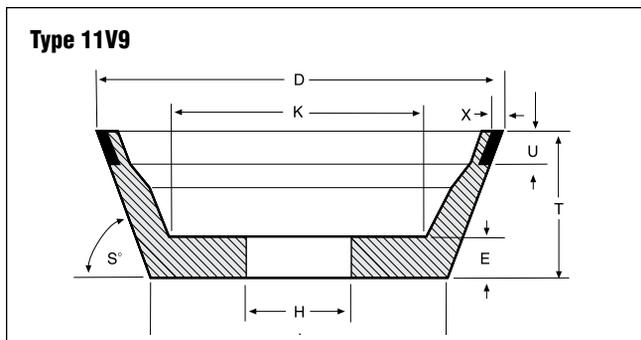
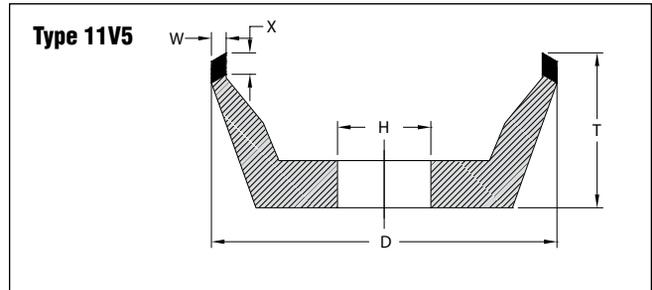
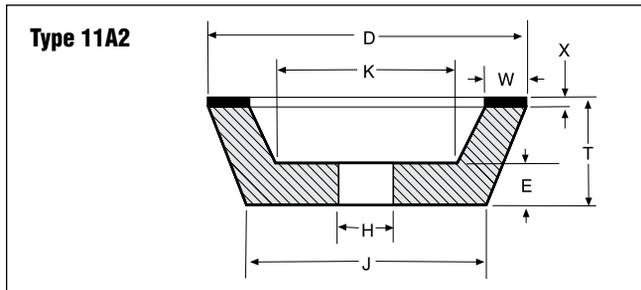

SEE PRODUCT IDENTIFICATION SYSTEM/USAGE INFORMATION ON PAGES 9-10 FOR ADDITIONAL INFORMATION.

**NORTON CNC EXPRESS MADE-TO-ORDER WHEELS**

Blank Stock Inventory to be altered to your specifications with 5-10 days

Wheel Shape	Tool Material	Application	G-Force Specification AD = Diamond BX = cBN	Diameter D	THK. T	Hole H	Abr. Depth X	Angle (V) or Radius (R)									
	WC	Fluting	AD320-UP061E	5	7/16" min. to 1/2" max.	1/2" min. to 2" max.	1/2"	-									
	HSS	Fluting	BX320-UP241E	5													
	WC	Fluting	AD320-UP061E	6													
	WC	Fluting	AD320-UP061E	5				7/16" min. to 1/2" max.	1/2" min. to 2" max.	1/2"	1 deg. - 30 deg.						
	WC	Fluting	AD320-UP061E	6													
	HSS	Fluting	BX320-UP241E	5													
	WC	Gashing	AD320-UP531E	5							7/16" min. to 1/2" max.	1/2" min. to 2" max.	1/2"	1 deg. - 55 deg.			
	HSS	Gashing	BX320-UP531E	5													
	WC	Fluting	AD320-UP061E	5										7/16" min. to 1/2" max.	1/2" min. to 2" max.	1/2"	90 deg. to 178 deg.
	HSS	Fluting	BX320-UP241E	5													
	WC	Fluting	AD320-UP061E	6													
	WC	Fluting	AD320-UP061E	5													7/16" min. to 1/2" max.
	HSS	Fluting	BX320-UP241E	5													
	WC	Fluting	AD320-UP061E	6													
	WC	Fluting	AD320-UP061E	5	7/16" min. to 1/2" max.	1/2" min. to 2" max.	1/2"										
	HSS	Fluting	BX320-UP241E	5													
	WC	Fluting	AD320-UP061E	6													
	WC	Fluting	AD320-UP061E	5				7/16" min. to 1/2" max.	1/2" min. to 2" max.	1/2"							
	HSS	Fluting	BX320-UP241E	5													
	WC	Fluting	AD320-UP061E	6													

Note: all of the wheel shapes listed can also be designated to have .010 relief(s) 1 side, or 2 sides on 1A1P and 1A1RN wheels.

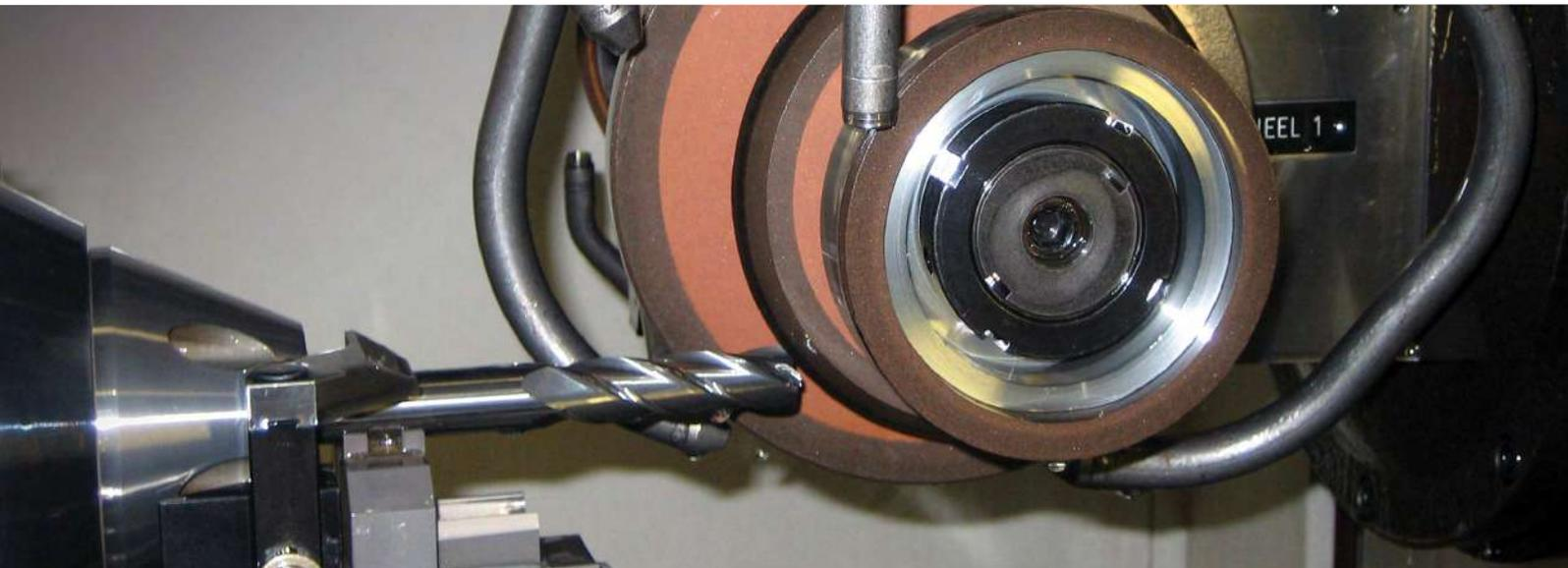

## OFF-LINE TRUING WHEELS

Off-line truing is a process used to restore wheel truth to the axis of rotation, wheel profiles, or proper geometry in response to grinding wheel breakdown. Norton truing wheels are available in silicon carbide (39C) or aluminum oxide (38A) formulations.

**Silicon Carbide 39C** grain is a hard and sharp grain, best used on bond systems like Metal Bond, Polyimide bonds, and very durable phenolic resin bonds.

**Aluminum Oxide 38A** is a more friable grain, best suited for eroding bond in the truing process. Use this on softer phenolic resin and Paradigm technologies.

**MicroDressing Wheels** should be used to dress 400 grit or finer diamond and cBN grinding wheels. They can be used in dry or wet dressing conditions.



### CONVENTIONAL TRUING WHEELS

SIZE D x T x H	SPECIFICATION	UPC #	STD. PKG.
<b>TYPE 1</b>			
7 x 1/4 x 1-1/4	39C80-JVK	66252940007	10
	39C100-IVK	66252940109	10
	39C120-IVK	66252940111	10
	38A60-IVBE	66252939696	10
	38A60-JVBE	66252939698	10
	38A60-KVBE	66252939700	10
	38A80-IVBE	66252939808	10
	38A80-JVBE	66252939809	10
	38A80-KVBE	66252939812	10
	38A100-IVBE	66252939823	10
	38A100-JVBE	66252939826	10
	38A100-KVBE	66252939827	10
7 x 1/2 x 1-1/4	39C80-IVK	66252941617	10
	39C80-JVK	66252941618	10
	39C100-HVK	66252941622	10
	39C100-IVK	66252941624	10
	39C120-IVK	66252941632	10
	38A60-IVBE	66252941036	10
	38A60-JVBE	66252941038	10
	38A60-KVBE	66252941041	10
	38A80-IVBE	66252941048	10
	38A80-JVBE	66252941049	10
	38A80-KVBE	66252941054	10
	38A100-IVBE	66252941163	10
38A100-JVBE	66252941165	10	
38A100-KVBE	66252941168	10	
7 x 3/4 x 1-1/4	39C80-JVK	66252942096	10
	39C100-JVK	66252942104	10
	38A60-IVBE	66252942207	10
	38A60-KVBE	66252942060	10

SIZE D x T x H	SPECIFICATION	UPC #	STD. PKG.
<b>TYPE 1 (CONTINUED)</b>			
8 x 1/4 x 1-1/4	39C80-IVK	66253014526	10
	38A60-IVBE	66253043431	10
	38A60-JVBE	66253043432	10
	38A60-KVBE	66253010825	10
	38A80-IVBE	66253043437	10
	38A80-JVBE	66253043439	10
	38A80-KVBE	66253043461	10
	38A100-IVBE	66253043445	10
	38A100-KVBE	66253043447	10
	8 x 3/8 x 1-1/4	39C80-IVK	69936664144
8 x 1/2 x 1-1/4	39C80-IVK	66253044015	10
	39C100-IVK	66253044017	10
	38A60-IVBE	66253043757	10
	38A60-JVBE	66253043758	10
	38A60-KVBE	66253043761	10
	38A80-IVBE	66253043766	10
	38A80-JVBE	66253013787	10
8 x 3/4 x 1-1/4	38A80-KVBE	66253043869	10
	38A100-KVBE	66253043877	10
	39C80-IVK	66253350645	10
	39C100-IVK	66253044314	10
38A60-IVBE	66253044184	10	

### MICRO DRESSING WHEEL

SIZE D x T x H	SPECIFICATION	UPC #	STD. PKG.
<b>TYPE 1</b>			
200mm x 10mm x 31.75mm	320 S/C Organic	66253296349	1

## TECHtip

- Wheel direction of rotation during truing must match the direction or rotation during use.
- Set the speed ratio in SFPM of truing wheel to superabrasive wheel to 3:1
- Use a minimum Truing wheel speed of 4500 SFPM
- Stick dress wheels after truing is recommend when extra abrasive exposure is required.



It is the user's responsibility to refer to and comply with ANSI B7.1

# NORTON BRAKE-CONTROLLED TRUING DEVICES

Designed for truing diamond and cBN wheels rapidly, effectively, and with a minimum of superabrasive loss. Recommended for wheels up to 12" in diameter.

## TYPICAL APPLICATIONS

- Truing straight, cup and cylinder wheels:
- Straight wheels, used on chip breaker, tool and cutter, surface, and cylindrical grinding machines
- Cup wheels, used on vertical spindle surface grinders
- Internal grinding wheels
- Cut-off wheels



### BETTER

### 4597 TRUING DEVICE

The 4597 is engineered for heavier and more frequent truing applications. The adjustable speeds allow for varying conditions (between 1050 and 1500 SFPM). It comes complete with a reusable case, "True to Form, Dress to Cut" training video, two 3" 38A60-M8VBE\* vitrified wheels, Truing Device Tips book and a dressing stick. It can be rebuilt using the 4597RK Rebuild Kit.

Worn #4597 Brake Controlled Truing Devices (UPC 66260195350) in need of reconditioning (beyond new shoes and springs) may be returned to be rebuilt. Contact Customer Service for return instructions and quote.

### BETTER

### 3597 PACESETTER TRUING DEVICE

The Pacesetter model is ideal for light-duty use. The pre-set brake speed requires no adjusting. This model includes one 3" 38A60-M8VBE\* vitrified wheel and can be rebuilt using the 3597RK Rebuild Kit.

\*The 3" 38A60-MVBE wheel is ideal for general purpose truing of 100 to 180 grit diamond and cBN wheels.

### BETTER

### 4597RK AND 3597RK REBUILD KITS

The truing devices can be rebuilt with these kits, consisting of 3 brake shoes, 3 springs, and 3 screws

ITEM	BETTER		GOOD	
	PRODUCT #	UPC #	PRODUCT #	UPC #
<b>TRUING DEVICES</b>				
4597 Brake-Controlled Truing Device	4597	66260195350		
3597 Pacesetter Brake-Controlled Truing Device	3597	66260135578		
<b>TRUING DEVICE REBUILD KITS</b>				
4597 Rebuild Kit	4597RK	66260195351		
3597 Pacesetter Rebuild Kit	3597RK	66260135595		
<b>REPLACEMENT WHEELS</b>				
3 x 1 x 1/2			38A60-MVBE	66243529145
			38A80-MVBE	66243529146
			37C60-MVK	66243529166
			37C80-HVK	66243529170
			37C80-MVK	66243529171
			37C100-HVK	66243529172
			37C100-MVK	66243529070

## SPECcheck

### TRUING DIAMOND AND cBN WHEELS

#### SUPERABRASIVE WHEEL TRUING WHEEL SPECIFICATION

#### RESIN AND VITRIFIED BOND

80, 100 and 120 grit	38A60-MVBE, 37C60-MVK
150, 180 and 220 grit	38A80-MVBE, 37C80-MVK
320 and finer grits	37C100-HVK

#### METAL BOND

80, 100 and 120 grit	38A60-MVBE
150, 180 and 220 grit	38A80-MVBE
240 and finer grits	37C80-HVK

## TECHtip

- Prior to truing the wheel, run a wax crayon over the wheel face. Important: do NOT use any liquid-based ink on superabrasive wheels.
- Any crayon left on the wheel face after truing will reveal untrued areas.
- Indicate the superabrasive wheel runout before starting... usually within .001" to .002", to minimize wheel loss.
- Mount the device spindle parallel to the wheel spindle to ensure proper straight face truing.
- For cup shaped wheels, the device spindle will be mounted perpendicular to the wheel spindle.
- Always use the Brake Controlled Truing Device dry.
- Bring the diamond/cBN wheel and the truing wheel together until they almost touch.

- Start the diamond/cBN wheel to normal speed; spin the truing wheel in the same direction at point of contact.
- Bring the two wheels together until they touch.
- Make sure the truing wheel is spinning at time of contact.
- Traverse the wheel back and forth at 30 to 60 inches/minute.
- Downfeed .0005" to .001" at the end of each traverse.
- At the end of truing, the diamond/cBN wheel should be smooth and in truth.
- Apply a dressing stick to sharpen the wheel.



It is the user's responsibility to refer to and comply with ANSI B7.1

## DIAMOND AND CBN WHEEL MOUNTING, TRUING AND DRESSING GUIDE

To achieve the best results using Norton diamond and cBN products, the following steps for mounting, truing and dressing should be practiced:

### MOUNTING – Putting Wheel on Machine Spindle

- Examine wheel flanges and spindle carefully.
- Be sure flanges' surfaces are clean and free of damage.
- Ensure that the mounting flanges are flat and of equal diameter, especially on wheels with rigid centers, such as vitrified bond wheels.
- Paper or plastic blotters should only be used when mounting superabrasive wheels with vitrified cores. Using paper or plastic blotters on any other core material may result in the wheel loosening during grinding.
- Inspect machine spindle for excessive runout.
  - TIR (Total Indicated Runout) should be no greater than 0.0002".
- Mount wheel between hand-tightened flanges.
- Using a dial indicator, tap the wheel lightly with a rubber or wooden block to minimize runout to less than .0010".
- Tighten flange securely and recheck with indicator.
- Allow a newly mounted wheel to operate for one full minute before grinding.
- The use of one permanent mounting for the life of the wheel is recommended whenever possible:
  - If the grinding machine has a tapered spindle, mount each straight, flaring cup or dish wheel on a separate collet or adapter.
  - When changing wheels the entire unit is removed, keeping the wheel in running truth.
  - When needed again, the entire unit can be placed directly on the spindle or arbor, thereby eliminating the time and abrasive lost in retruing.

### TRUING – Making Wheel Round and Concentric with the Spindle Axis

- Prior to truing the wheel, run a wax crayon over the wheel face. Important: do not use any liquid-based ink on superabrasive wheels.
- Any crayon left on the wheel face after truing will reveal untrued areas.
- Indicate the superabrasive wheel runout before starting... usually within .001" to .002", to minimize wheel loss.
- Norton brake-controlled truing devices are most commonly used to true Diamond and cBN straight, cup and cylinder wheels.
  - Mount the device spindle parallel to the wheel spindle to ensure proper straight face truing.
  - For cup wheels, the device spindle will be mounted perpendicular to the wheel spindle.
  - Always use brake-controlled truing device dry.
- Bring the diamond/cBN wheel and the truing wheel together until they almost touch.
- Start the diamond/cBN wheel to normal speed; start the truing wheel in the same direction.
- Bring the two wheels together until they touch.
- Make sure the truing wheel is spinning at time of contact.
- Traverse the wheel back and forth at 30 to 60 inches per minute.
- Downfeed .0005" to .001" at the end of each traverse.
- At the end of truing, the diamond/cBN wheel should be smooth and in truth.
- Apply a dressing stick to sharpen the truing wheel.

### DRESSING – Opening the Face of a Trued Wheel

- Dressing the abrasive – a cleaning/sharpening process to expose sharp, free-cutting grit:
  - For resinoid and vitrified bond wheels, the dressing stick should be one or two grit sizes finer than the abrasive in the diamond/cBN wheel – in a soft grade such as H or I.
  - For metal bond wheels, choose a stick with the same grit or one grit coarser than the wheel abrasive – in a medium grade (K – N).
  - See the "Dressing Stick" section for recommendations.
- Dressing the core – The core material (the part of the wheel that holds and supports the abrasive-bearing section) should never contact the work piece during grinding; rubbing will generate excessive heat. As the abrasive section of a cup wheel wears, the core material might become exposed, necessitating dressing.
  - Use a single-point carbide or steel tool to dress an exposed resalloy core.
  - Clamp the tool in a vise.
  - Direct the cutting edge accurately to leave a 1/16" of abrasive section exposed.

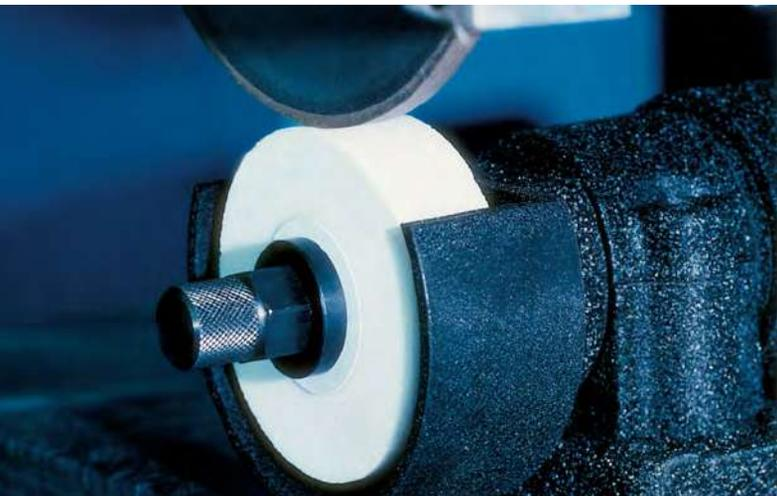

#### Properly Dressed Wheel Face

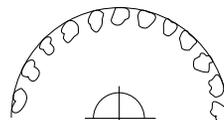

**AFTER TRUING**  
THE WHEEL FACE IS SMOOTH AND CLOSED

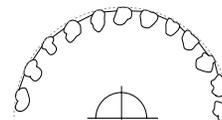

**AFTER DRESSING**  
THE WHEEL FACE IS OPEN WITH THE GRITS EXPOSED, READY FOR EFFICIENT GRINDING ACTION

**AFTER DRESSING cBN GRIT**



**TAIL (BOND SUPPORTING GRIT)**

**AFTER DRESSING**

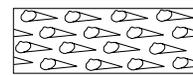

**PATH CONNECTING TAILS FOR COOLANT AND CHIP FLOW**

Regular use of properly selected dressing sticks will help you achieve maximum performance from your diamond and cBN wheels.

Selecting the appropriate dressing stick for each application depends on the wheel size, type, speed, specification, and grit size, as well as the material being worked. Initial starting specifications are listed below. We recommend testing several sticks to find the best one for your application.



## VITRIFIED DRESSING STICKS

SIZE T x W x L	STD. PKG.	SPECIFICATION	UPC #
<b>DRESSING STICKS – ALUMINUM OXIDE</b>			
For dressing cBN wheels, but also work well for diamond wheels			
1/2 x 1/2 x 4	5	38A220-HVBE	61463610555
1/2 x 1/2 x 6	5	38A150-IVBE	61463610303
		38A220-HVBE	61463610103
		38A150-HVBE	61463610291
3/4 x 3/4 x 4	5	38A150-IVBE	61463610368
		38A220-HVBE	61463610290
		38A150-HVBE	61463610280
3/4 x 3/4 x 8	5	38A150-HVBE	61463610405
		38A150-IVBE	61463610453
		38A220-HVBE	61463610406
1 x 1 x 6	5	38A120-IVBE	61463610390
		38A150-IVBE	61463610455
<b>DRESSING STICKS – SILICON CARBIDE</b>			
For dressing metal bond diamond wheels			
1/2 x 1/2 x 6	5	37C150-KV	61463610205
		37C220-KV	61463610214
3/4 x 3/4 x 6	5	37C150-LV	61463610375
1 x 1 x 6	5	37C80-NV	61463610393
		37C150-KV	61463610438
		37C220-KV	61463610398

## VITRIFIED SUPERFINE STICKS

SIZE T x W x L	STD. PKG.	SPECIFICATION	UPC #
<b>SUPERFINE STICKS – ALUMINUM OXIDE</b>			
For dressing fine grit diamond and cBN wheels			
1 x 1 x 6	5	PCD Coarse – 400 grit	61463647865
		PCD Fine – 800 grit	61463647867
1 x 1 x 8	5	NSA320-H8V	61463610597
<b>SUPERFINE STICKS – SILICON CARBIDE</b>			
For dressing fine grit diamond and cBN wheels			
1/2 x 1/2 x 6	5	NMVC320-J5VCA	61463610599
		NMVC400-J5VCA	61463650324
1 x 1 x 6	5	NMVC320-J5VCA	61463610605
		NMVC400-J5VCA	61463650450

## TECHtip

### DRESSING RESIN AND VITRIFIED BOND, DIAMOND AND CBN WHEELS

- Choose a dressing stick one or two grit sizes finer than the abrasive in the wheel – in a soft grade (H or I).

### METAL BOND, DIAMOND AND cBN WHEELS

- Choose a stick the same grit size or one grit size coarser than the abrasive in the wheel – in a medium grade (K–N).

It is the user's responsibility to refer to and comply with ANSI B7.1

## SPECcheck

### STARTING RECOMMENDATIONS – DRESSING DIAMOND AND cBN WHEELS

Selecting the appropriate dressing stick for each application depends on the wheel size, type, speed, specification, and grit size, as well as the workpiece material. Initial starting specifications are listed below. We recommend testing several sticks to find the best one for your application.

SUPERABRASIVE WHEEL	VITRIFIED STICK	SPECIFICATION
PRODUCT		
<b>RESIN AND VITRIFIED BOND WHEELS</b>		
80, 100 and 120 grit	Dressing Stick	38A150-HVBE
150, 180 and 220 grit	Dressing Stick	38A220-HVBE
320 and finer grits	Superfine Stick	NMVC400-J5VCA
<b>METAL BOND</b>		
80, 100 and 120 grit	Dressing Stick	37C80-NV
150, 180 and 220 grit	Dressing Stick	37C150-KV
240 and finer grits	Dressing Stick	37C220-KV





**METHODS OF TRUING AND DRESSING**



**FORM ROLL: PLUNGE DRESSING**

- Diamond roll geometry matches geometry of part to be ground
- Roll is fed into grinding wheel to generate the desired form and wheel surface condition
- Used where lowest cycle time and highest accuracy is required

**DRESSING DISC: UNI-AXIAL TRAVERSE DRESSING**

- Diamond dressing disc has a thin diamond section that is traversed across the face of the grinding wheel
- Profile is generated with a CNC program or template
- Used for simple profiles or where flexibility is necessary

**DRESSING SPINDLES**

HORSEPOWER	RPM
<b>NORTON AC DRESSING SPINDLES</b>	
0.5 hp	5,500
1.0 hp	3,600
1.5 hp	7,000
<b>NORTON MAXTORQ – DC BRUSHLESS DRESSING SPINDLES</b>	
0.5 hp	8,000
1.0 hp	12,000
2.0 hp	6,000
<b>NORTON HYDRO – HYDRAULIC DRESSING SPINDLES</b>	
1.5 hp	1,800, 2,400, 3,600, 12,000
3.0 hp	7,000
4.0 hp	2,400

\*HP LISTED AT 100% EFFICIENCY, 500 PSI @ 5 GPM

**NORTON HEAVY-DUTY TWIN GRIP SPINDLES**

For heavy duty applications, Norton offers a twin grip heavy duty belt driven system with outboard bearing support. Horsepower and rpm can be customized for the application.

**NORTON QUICK-CHANGE HYDRAULIC SYSTEM**

For quick changeover, Norton offers an electric motor driven, hydraulic centers clamping system. This is available on select systems with outboard roller support

**ACCESSORIES**

Various accessories are available for dressing spindles and devices:

- Acoustic Emission Sensors
- Custom Mounting Brackets
- Electrical Enclosure
- Cables
- Drives (DC)
- Suitcase Demo Kit



## TYPES OF FORM ROLLS

Norton manufactures two types of plunge dressing rolls: infiltrated diamond form rolls and reverse plated diamond rolls. The following lists comparisons between the two types.

### INFILTRATED DIAMOND FORM ROLLS

- Powder Metal-High Temp Proc
- “Lapped” for precision
- Manual setting of diamond
- Lower cost for simple rolls
- Ability to be re-conditioned
- Rugged (good in abusive ops)

### REVERSE PLATED DIAMOND FORM ROLLS

- Electroplated Nickel- Low Temp Proc
- Precision built in process
- Mechanical setting of diamond
- Lower cost for complex rolls
- Reconditioning not recommended
- Fragile (Heat and Impact)

## INFILTRATED DIAMOND FORM ROLLS

Each diamond is hand set and secured in place with a very tough tungsten/bronze matrix which allows for a wide range of customizable options (concentration, patterns, reinforcement, grit type, etc.). The toughness of the tungsten based matrix makes these diamond rolls ideal for aggressive and harsh environments.

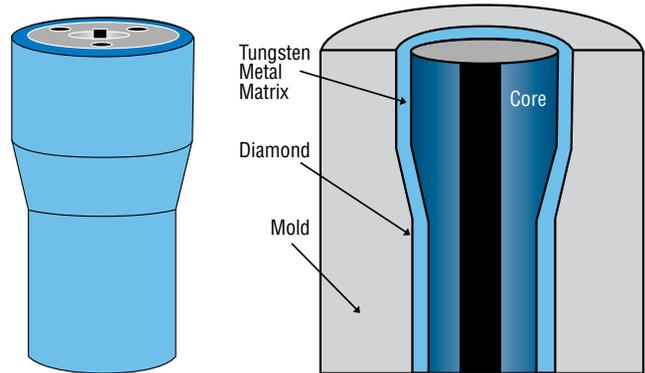

### INFILTRATED TECHNOLOGY

#### Strengths

- Rugged product can withstand rougher treatment
- Can be reconditioned (“relapped”) to extend life
- Broad size range offering (small and large)
- Can be customized (grit size, type, reinforcement, etc.)

#### Weaknesses

- High labor content (setting and lapping) adds cost to complex forms
- Diamond “lapped” to obtain form accuracy, may close wheel
- High labor content controls lead-times

### WHEN TO USE INFILTRATED FORM ROLLS

- Simple Profiles/Forms
- Short Runs- job shop applications
- Abusive operations or applications
- Geometries with thin, tall fins
- Customers with reconditioning programs
- Dry applications, or high heat (like with resin bond)

## SPECIFICATIONS EXAMPLE: IFR - D - 2025 - LOC

ROLL TYPE	DIAMOND TYPE	GRIT SIZE	SPECIAL MODIFIERS (FOR INTERNAL USE)
IFR - Infiltrated Form Roll	D - Natural Diamond	<b>Crushed Grit</b>	Combination of up to 11 letters for internal manufacturing use
	SD1 - Medium Quality Synthetic	1618 - 16/18 Mesh	
	SD2 - High Quality Synthetic	1820 - 18/20 Mesh	
		2025 - 20/25 Mesh	
		2530 - 25/30 Mesh	
		3040 - 30/40 Mesh	
		3035 - 30/35 Mesh	
		3540 - 35/40 Mesh	
		4050 - 40/50 Mesh	
		4550 - 45/50 Mesh	
	5060 - 50/60 Mesh		

## REVERSE-PLATED DIAMOND FORM ROLLS

Diamond is secured with an electroplated nickel matrix. Diamond is randomly distributed throughout the form roll, with a very high concentration. Because the precision of the diamond profile is designed into the manufacturing process, the diamond is not usually shaped or “lapped”. By not lapping the diamond, the sharp, natural points provide a good dressing action resulting in an open grinding wheel, lower grinding forces and thus a more accurate part. For profiles requiring extremely tight tolerances, lapped reverse-plated form rolls are also available.

This technology is very sensitive to heat and impact and must be used in highly controlled processes

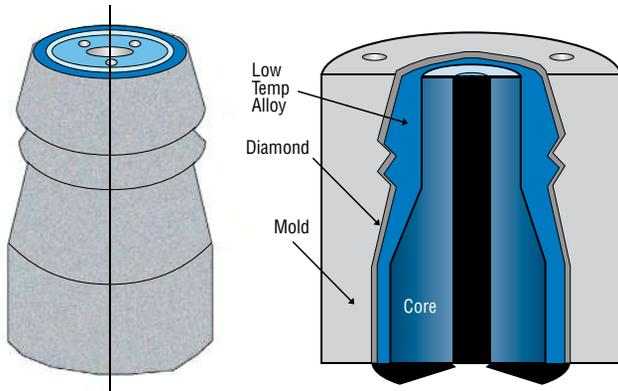

CLOSE-UP OF REVERSE-PLATED DIAMOND FORM ROLL

### REVERSE-PLATED TECHNOLOGY

#### Strengths

- Relative low cost for complex, intricate forms
- High diamond concentration extends form holding / life
- Close tolerances “out of the mold” ( $\pm 0.005\text{mm}$  /  $\pm .0002$ )
- Sharper diamonds, with little or no lapping

#### Weaknesses

- Fragile! Sensitive to heat and impact
- Reconditioning “re-lap” not usually recommended (closes wheel)
- Not available in smallest sizes (<40mm OD, <12mm wide)
- Electroplating cycle controls lead-times

### WHEN TO USE REVERSE-PLATED FORM ROLLS

- Continuous Dress Creep Feed
- Complex forms
  - Fuel injection
  - Thread forms
  - Aerospace root / tree forms
- Long form life
  - Higher diamond concentration
- Most Bearing and Aerospace Customers
  - Exceptions for old equipment or unskilled work force

### SPECIFICATIONS EXAMPLE: RPC - D - 2025 - AEP

ROLL TYPE	DIAMOND TYPE	GRIT SIZE	SPECIAL MODIFIERS (FOR INTERNAL USE)
RPC - Reverse Plated Form Roll	D - Natural Diamond	Crushed Grit	Combination of up to 11 letters for internal manufacturing use
	SD1 - Medium Quality Synthetic	1618 - 16/18 Mesh	
	SD2 - High Quality Synthetic	1820 - 18/20 Mesh	
		2025 - 20/25 Mesh	
		2530 - 25/30 Mesh	
		3040 - 30/40 Mesh	
		3035 - 30/35 Mesh	
		3540 - 35/40 Mesh	
		4050 - 40/50 Mesh	
		4550 - 45/50 Mesh	
		5060 - 50/60 Mesh	
		6070 - 60/70 mesh	
		7080 - 70/80 Mesh	
		8001 - 80/100 Mesh	
	0112 - 100/120 Mesh		

## INFILTRATED DRESSING DISCS

- Infiltrated dressing discs use the same tough tungsten matrix as infiltrated form rolls making them ideal for aggressive dressing applications.
- Available using synthetic, natural, or CVD log diamonds
- For use where the smallest included angles are needed (down to 0.005" radius)
- Like infiltrated form rolls – these rolls are hand set and can be customized for your application needs.
- Ideal for profiling ceramic and A/O conventional grinding wheels
- Can be re-lapped to achieve longer life



MICROSCOPIC VIEW OF A CVD INFILTRATED DRESSING DISCS EDGE



MICROSCOPIC VIEW OF A CONVENTIONAL INFILTRATED CNC DRESSING DISC EDGE



CLOSE-UP OF INFILTRATED DRESSING DISC EDGE

### SPECIFICATIONS EXAMPLE: **ICD - CVD - 201006 - CEF**

ROLL TYPE	DIAMOND TYPE	GRIT SIZE	SPECIAL MODIFIERS (FOR INTERNAL USE)
<b>ICD</b> - Infiltrated CNC Dressing Disc	<b>D</b> - Natural Diamond	<b>Crushed Grit</b>	Combination of up to 11 letters for internal manufacturing use
	<b>SD1</b> - Medium Quality Synthetic	1618 - 16/18 Mesh	
	<b>SD2</b> - High Quality Synthetic	1820 - 18/20 Mesh	
	<b>CVD</b> - CVD Synthetic Diamond	2025 - 20/25 Mesh	
		2530 - 25/30 Mesh	
		3040 - 30/40 Mesh	
		3035 - 30/35 Mesh	
		3540 - 35/40 Mesh	
		4050 - 40/50 Mesh	
		4550 - 45/50 Mesh	
		5060 - 50/60 Mesh	
		6070 - 60/70 mesh	
		7080 - 70/80 Mesh	
		8001 - 80/100 Mesh	
	0112 - 100/120 Mesh		
		<b>CVD Grit (For ICD Rolls Only)</b>	
		6 digit number indicating H x L x W of CVD Ex. 300606 = 3 x 0.6 x 0.6 CVD	

## BPR DRESSING DISCS

- BPR dressing discs consist of a single consumable layer of high quality synthetic diamond secured with a brazed metal matrix
- Diamond and metal matrix are chemically bonded so diamond retention is not depended on pocket size
- Single layer of consumable diamond eliminates need for lapping resulting in improved life
- Available in 0.005", 0.010", 0.015", 0.020", and 0.025" radii
- Best for truing and dressing Vitriified cBN wheels but can also be used for conventional wheels with low depth of dress.



BPR DRESSING DISC EDGE CLOSE-UP

### SPECIFICATIONS EXAMPLE: **BPR - SD2 - 2025 - ALO**

ROLL TYPE	DIAMOND TYPE	GRIT SIZE	SPECIAL MODIFIERS
<b>BPR</b> - BPR CNC Dressing Disc	<b>SD2</b> - High Quality Synthetic	<b>Crushed Grit</b>	Combination of up to 11 letters for internal manufacturing use
		1820 - 18/20 Mesh	
		2025 - 20/25 Mesh	
		2530 - 25/30 Mesh	
		3040 - 30/40 Mesh	
		3035 - 30/35 Mesh	
		3540 - 35/40 Mesh	
		4050 - 40/50 Mesh	
		4550 - 45/50 Mesh	
		5060 - 50/60 Mesh	
		6070 - 60/70 mesh	
		7080 - 70/80 Mesh	

## IDW DRESSING DISCS

- This type of dressing disc consists of diamonds bonded in a hot-pressed metal matrix for superior durability
- Consumable layer of diamond allows for superior life
- Usually up to 2mm flat diamond section width (no radius) – wider widths available based on application.
- This is a specialty product used for straight profiling of Vitrified cBN wheels and is not recommended for use on conventional wheels.
- Has seen most success in straight dressing vitrified cBN wheels in automotive applications (cam and crank).
- Typically available in 30/40 and 40/50 grit mesh sizes – other sizes available based on application needs.



CLOSE-UP OF IDW DRESSING DISC DIAMOND EDGE

### SPECIFICATIONS EXAMPLE: **IDW - D - 4050 - ALO**

ROLL TYPE	DIAMOND TYPE	GRIT SIZE	SPECIAL MODIFIERS
IDW - IDW CNC Dressing Disc	D - Natural Diamond	<b>Crushed Grit</b> 3040 - 30/40 Mesh 4050 - 40/50 Mesh	Combination of up to 11 letters for internal manufacturing use

## DRESSING DISC RECOMMENDATIONS

WHEEL TECHNOLOGY	OD STRAIGHT	OD SIMPLE PROFILE	OD COMPLEX PROFILE	OD AND FACE
CONVENTIONAL VITRIFIED ALUMINUM OXIDE	INFILTRATED	INFILTRATED	INFILTRATED	INFILTRATED
CERAMIC VITRIFIED (NORTON QUANTUM X, SG, QUANTUM VS3)	INFILTRATED WITH CVD	INFILTRATED WITH CVD	INFILTRATED WITH CVD	INFILTRATED WITH CVD
RESIN CBN OR DIAMOND (NORTON G-FORCE, B99, ETC)	BPR	BPR	BPR	BPR CUP
VITRIFIED CBN OR DIAMOND	IDW	IDW	BPR	BPR CUP

## HOW TO ORDER ROTARY DRESSING TOOLS

Provide the following information to your local sales representative or customer service representative

### Legible blueprint of roll, wheel, or part with the following geometry:

- Overall diameter
- Overall length
- Bore size and tolerances required
- Mounting pattern
- Any feature with tolerances less than 0.0002" (5 um) must be clearly defined for engineering review.
- If designing from a part, a fully dimensioned part drawing is required
- Abrasive type (natural diamond, synthetic diamond, CVD stones, etc.)
- Specification of wheel to be dressed (need at least the grit type and size)
- Dressing type (Plunge or CNC Profiling)

## GEOMETRIC AVAILABILITY

**Diameter:** 2.000" - 12.000" [50.80mm - 304.80mm]

**Width:** 1.000" - 8.500" [25.40mm - 215.90mm] (one piece)

### Form Tolerances:

*Profile:* +/- 0.000080" [0.002mm]

*Radius:* +/- 0.0002" [0.005mm]

*Step Relationship:* +/-0.00005" [0.0013mm]

*Profile Angularity:* +/- 0.00005" [0.0013mm]

**Concentricity Band to Bore TIR:** 0.00008" [0.002mm]

**Diamond to Bore TIR:** 0.0002" [0.005mm]

**Bore Diameter Tolerance:** (+0.0001", -0.0000") [+0.004mm, -0.000mm] up to 4" length

\* AVAILABILITY LISTED ABOVE MAY NOT BE AVAILABLE FOR CERTAIN DIAMOND ROLL FORMS OR DIAMOND ROLL TYPES. ALL AVAILABILITY IS SUBJECT TO REVIEW BY NORTON'S DESIGN ENGINEERING TEAM.

**NORTON STATIONARY  
DIAMOND DRESSING TOOLS**

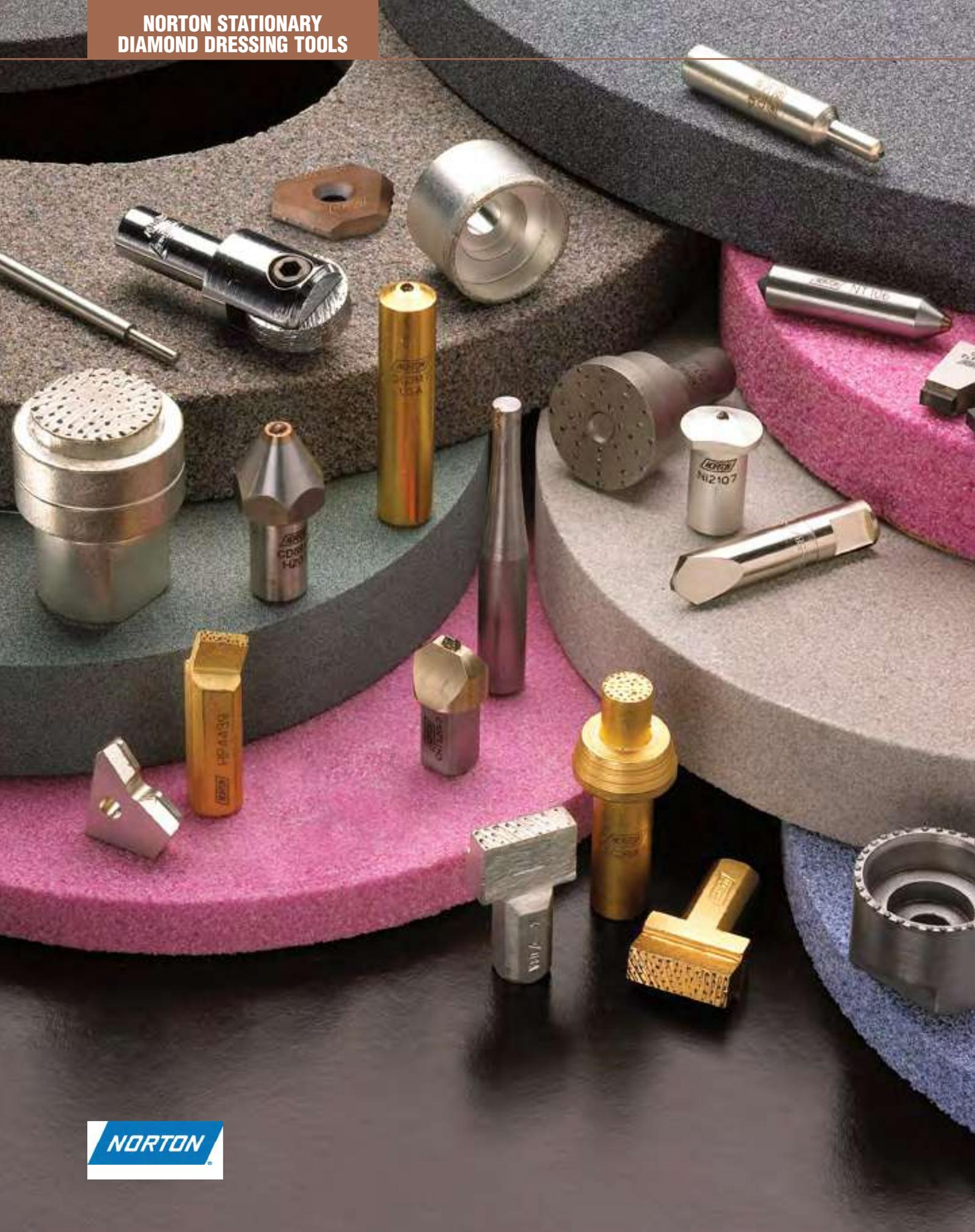

**NORTON LEADS THE TRUING AND DRESSING TOOL INDUSTRY IN ENGINEERING AND MANUFACTURING TECHNOLOGY**

**Stock Tools**

The broadest line of stationary diamond dressing tools and brake-controlled truing devices.

**Custom-engineered Tools**

We have custom tools for virtually every application. When Norton quality stock products do not fulfill your requirements for diamond quality or geometry, your Norton distributor, Norton sales representative and our product engineering staff will work with you to ensure that you get the right stationary diamond tool for your job on a custom design basis.

**Resetting and Relapping Service**

Norton offers expert resetting (removing single point diamond, rotating and exposing sharp, new point) and relapping (reconditioning form tool diamonds) of many of our tools – at a significant cost savings vs. new manufacture. Contact the Norton Customer Service group for a quote, current lead-times, and return procedures.

**LOWER YOUR COST PER DRESSING APPLICATION**

Diamonds are a rare commodity. The larger the stone and the better the quality, the higher the initial cost. The key to successful diamond tool purchasing and use is based on the “cost per dress.” Normally, higher quality diamond dressing tools and a proactive resetting program will result in lowest “cost per dress.”

In those situations where a resetting program is not feasible, or low, initial cost is the primary purchasing criteria, Norton offers an extensive line of non-resettable tools.

**See page 109 for information needed for a “Competitive Tool Analysis” – to help you convert to a quality Norton diamond dressing tool.**



**HOW TO CHOOSE THE CORRECT DIAMOND DRESSING TOOL FOR YOUR APPLICATION**

**1 If you know the tool:**

Find the appropriate tool section, then match your tool to the drawings in that section.

**2 If you don't know the tool, but know the wheel form needed:**

Find the type of wheel form to be dressed using the wheel form symbols shown throughout the book. Note the appropriate tool(s).

**3 If you don't know the tool, but know the machine:**

Use the “Stationary Diamond Tool Recommendations by Machine Type” chart on pages 105-108. Note the appropriate tool(s).

**4** Then review the recommended tools' features and benefits in their catalog sections to choose the best tool for your operation. If you need engineering assistance, contact your local Norton representative.

**RESETTING – MINIMIZING YOUR COST**

Buying a higher quality diamond is your best value, especially if you participate in a proactive resetting program. Although initial cost may be higher, the payback comes through several factors:

- Diamond durability, providing longer tool life
- Tighter form tolerances
- Consistent finish rates
- Resetting the diamond lowers the overall tooling cost

Used properly, the overall cost of a higher quality, resettable diamond will compare favorably with that of an inexpensive, non-resettable diamond. Initially, the best diamond point is selected for use. When returned, the next best diamond point is selected for resetting, and so on.

To ensure you get the best value for your diamond:

- Rotate the diamond tool ¼ turn periodically to maintain a sharp point
- Use proper flow of coolant to protect the diamond from heat which can create fracturing of the diamond
- Excessive wear on the diamond point may impact the ability to reset the diamond. The widest point of the diamond is referred to as the girth. The diamond girth is buried in a powder metal matrix. Using a diamond into the girth zone might impact the ability to reset other diamond points

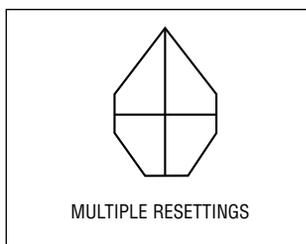
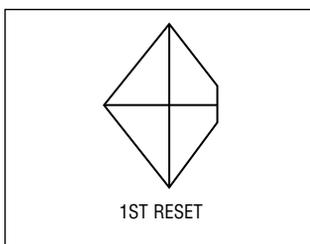
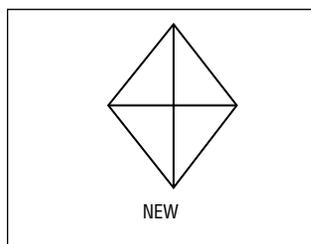

# TECHtip

## WHEEL CONDITIONING

Stationary diamond dressing tools are used to condition grinding wheels. Wheel conditioning involves two operations: truing and dressing.

### Truing the Wheel:

Primarily done during the initial set-up, truing involves three basic operations:

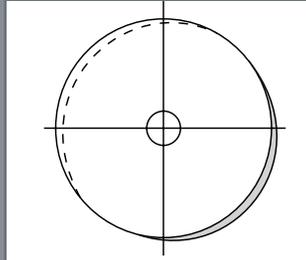

CLEANING THE WHEEL TO MAKE IT RUN TRUE WITH THE AXIS OF ROTATION

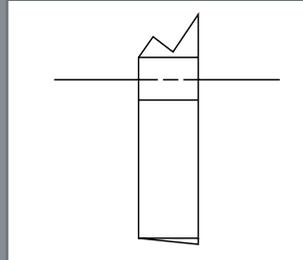

RESTORING THE WHEEL PROFILE TO PROPER GEOMETRY IN RESPONSE TO WHEEL BREAKDOWN

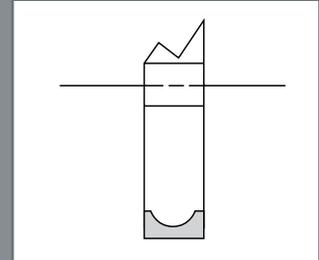

CHANGING THE PROFILE OF THE WHEEL TO THE DESIRED SHAPE

### Dressing the Wheel:

Dressing is done intermittently throughout the operation – after a certain number of parts are ground, as wheel loads, closes up, etc. – to keep the wheel at peak performance.

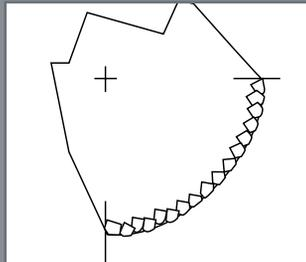

REMOVING DULL ABRASIVE PARTICLES OPENS THE WHEEL, INCREASING STOCK REMOVAL RATES, DECREASING SURFACE FINISH QUALITY.

DULLING THE ABRASIVE PARTICLES CLOSES THE WHEEL, INCREASING SURFACE FINISH QUALITY, DECREASING STOCK REMOVAL RATES.

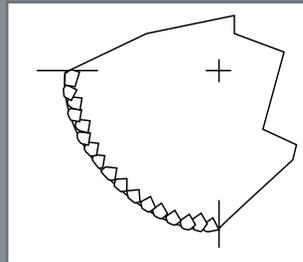

REMOVING FOREIGN MATERIAL FROM A "LOADED" WHEEL OPENS THE WHEEL, EXPOSING NEW CUTTING GRAINS.

## TYPICAL WHEEL FORMS DRESSED BY STATIONARY DIAMOND TOOLS

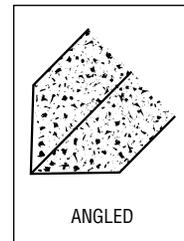
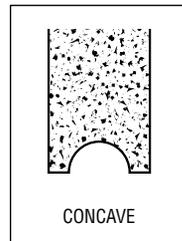
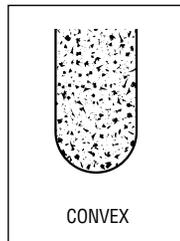
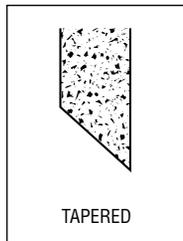
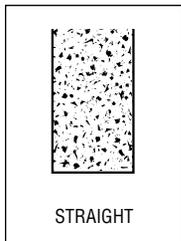



# SPECcheck

## GUIDELINES FOR LEAD SELECTION

Use the optimum traverse rate of a diamond tool to appropriately condition the wheel face for your grinding operation.

**Slower lead (and traverse rate) tends to close up the wheel face to provide:**

- Better finishes (low RMS/Ra readings)
- Lower stock removal rates

**Faster lead (and traverse rate) tends to open up the wheel face to provide:**

- Faster stock removal rates (“hungry” wheel)
- Rougher finishes (high RMS/Ra readings)

**Formula for Traverse Rate:** Speed of Wheel (RPM) x Lead Selection Per Wheel Revolution = Traverse Rate (Inches Per Minute)

**To Convert RPM to SFPM:** Multiply wheel diameter in inches X RPM X 0.262

TOOL TYPE	LEAD SELECTION / TRAVERSE RATE
<b>Single Point Tools</b>	Coarse Finish = .008" - .010" per wheel revolution
<b>Form Tools</b>	Medium Finish = .005" - .007" per wheel revolution
	Fine Finish = .002" - .004" per wheel revolution
<b>EXAMPLE – SINGLE POINT</b>	
Wheel:	14 x 1-1/2 x 5" 5SG60-KVS
Tool:	SG5M7 (1/2 carat Single Point)
Wheel Speed:	6500 SFPM = 1773 RPM
Stock Removal/Finish:	Medium/32 RMS
Lead Selection:	.006" per wheel revolution
Travers Rate:	1773 x .006 = 10.6" per minute traverse
<b>Multi-Point (Grit) Tools</b>	Coarse Finish = .023" - .030" per wheel revolution
<b>Blade Tools</b>	Medium Finish = .013" - .022" per wheel revolution
<b>Cluster Tools</b>	Fine Finish = .006" - .012" per wheel revolution
<b>EXAMPLE – MULTI-POINT</b>	
Wheel:	7 x 1 x 1-1/4" 32A60-KVBE
Tool:	1R6J6 (1/4" round tool)
Wheel Speed:	6500 SFPM = 3547 RPM
Stock Removal/Finish:	Coarse/64 RMS
Lead Selection:	.024" per wheel revolution
Traverse Rate:	3547 x .024 = 85.1" per minute traverse



**POSITIVE INFLUENCES ON STATIONARY TOOLS**

**Coolant – Dress Wet**

- Use coolant with ample pressure, volume, and filtration whenever possible.
- A stationary tool used with coolant will last longer than a tool used without coolant.

**Rigid Tool Holder**

- A rigid tool holder will keep vibration to a minimum.
- Vibration in the tool holder will create an inconsistent surface on the grinding wheel and eventually cause the diamond in the tool to crack.

**Minimal Infeeds**

- Using manufacturer’s suggested amounts will allow for maximum tool life.
- Avoid excessive infeeds – excessive infeed creates damaging heat and a tendency to damage the diamond.

**Proper Alignment**

- Blade and Chisel-type tools require proper alignment to perform correctly and obtain maximum life expectancy.

**SPECcheck**

**TROUBLESHOOTING GUIDE**

<b>PROBLEM</b>	<b>POSSIBLE CAUSES</b>	<b>SUGGESTED CORRECTION</b>
<b>Chatter</b>	Tool not secure Diamond traversing too slowly Wheel loaded Worn diamond	Remount or check for worn or loose holder Use faster traverse Dress more frequently Rotate tool or replace
<b>Burn</b>	Tool traversing too slowly Poor coolant on part and tool Diamond too flat Diamond too large	Increase traverse rate Increase coolant flow at point of contact Rotate or replace tool Reduce size or try multi-point tool
<b>Scratches</b>	Wheel too rough Coolant	Slow down traverse Check filtration
<b>Diamond lines</b>	Traversing too fast No dwell time	Slow down dress rate Increase sparkout
<b>Inaccuracies in parts</b>	Cam worn Poor mounting Worn tool Tool too tight	Replace temple and follower Check mounting and alignment Check rest and locations for movement Tool is bent. Replace.
<b>Parts too hot</b>	Dressing too slowly Diamond too flat	Increase crossfeed rate Rotate or replace tool
<b>Wheel is loaded</b>	Dressed too infrequently Infeed too light	Dress more often Increase infeed amount
<b>Wheel acts too soft</b>	Overdressing	Reduce infeed rate and slow crossfeed
<b>Wheel doesn’t cut</b>	Wheel closed	Increase infeed rate and increase crossfeed
<b>Short diamond life</b>	Vibration Lack of coolant Infeed cycle Poor mounting Hogging	Remove shock from diamond contact area Clean coolant line Reduce excessive infeed Secure tool, do not over-tighten, seat into holder properly Do not exceed recommended infeeds If single-point - rotate tool, use drag angle If multi-point - must be flush with wheel face, increase from single-point crossfeed rate, break in tool correctly
<b>Diamond Breakage</b>	Storage Pressure Temperature	Keep protected from shock Reduce heavy infeed Control sudden changes

## SINGLE POINT TOOLS

The unparalleled, Norton line of single point tools sets the industry standard for straight and simple form dressing applications. Our extensive offering of numerous, high quality diamond tools includes: resettable and non-resettable products, tools for all abrasive types (conventional and advanced ceramic grains) and the technology-leading Norton "Indexable" tool design.

### WHEEL FORMS DRESSED BY THESE TOOLS



STRAIGHT



TAPERED



CONVEX



## TECHtip

- Rigidly mount single point tools at a 10° - 15° angle to the wheel centerline with a line drawn through the center of the wheel, pointing in the direction of wheel travel.
- Point of contact should be slightly below centerline of wheel as shown.
- Use coolant whenever possible.
- Normal infeed is .001" per pass.
- Lead selections range from .002" - .010" per wheel revolution.
- Rotate the tool 1/4 turn periodically to maintain a sharp point.

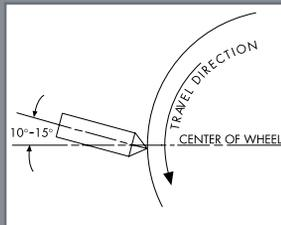

To optimize applications using ceramic abrasives and/or tools, normal dressing parameters must change. Reduce infeed by 25%. Significant reductions in the amount of infeed and frequency of dress will result in substantially lower cost per part ground.

### SINGLE POINT DRESS TRAVERSE RATE

Select a Lead Value based on desired Surface Finish and run the formula below.

FINISH	LEAD VALUE (PER WHEEL REVOLUTIONS)
For Coarse Finish (approx. 64 RMS)	.008" to .010"
For Medium Finish (approx. 32 RMS)	.005" to .009"
For Fine Finish (approx. 16 RMS)	.002" to .004"

**LEAD VALUE X WHEEL SPEED (RPM) = TRAVERSE RATE IN INCHES/MINUTE**

- Slower traverse rates result in a closed wheel face and lower surface finish readings on the workpiece.
- Faster traverse rates result in an open wheel face that produces greater stock removal and a rougher workpiece finish.



It is the user's responsibility to refer to and comply with ANSI B7.1

## NORTON SINGLE POINT DIAMOND QUALITY LEVEL DESIGNATIONS

Norton adheres to the Industrial Diamond Association's standards for diamond weight tolerances.

QUALITY LEVEL	SETTABLE POINTS	STRUCTURE AND SHAPE	INTEGRITY
<b>AA</b>	Four settable points	Well defined octahedron or dodecahedron	Smooth surfaces, free of cracks, seams or surface imperfections
<b>SG</b>	Three settable points	Well defined dodecahedron with minor surface irregularities	Free of major cracks, may have seams or imperfections
<b>A</b>	Three settable points	Blocky, pointed structure, octahedrons or dodecahedrons, with minor surface irregularities	Free of major cracks, may have seams or imperfections
<b>NS Norton Standard</b>	Two settable points	Blocky structure, octahedrons, or dodecahedrons, with minor surface irregularities	May have cracks, seams or defects away from point
<b>BCSG</b>	One point; non-resettable	One well defined dodecahedron point	May have cracks, seams or defects away from point
<b>BC</b>	One point; non-resettable	Blocky-shaped octahedron with rough surface and irregularities	May have cracks/seams/defects around point. Defects may decrease average tool life
<b>Octahedron:</b>	An 8-sided diamond which can have a maximum of six pyramid-shaped points. 		
<b>Dodecahedron:</b>	A 12-sided diamond which can have a maximum of six broader-shaped points. 		

# SPECcheck

## SELECTION GUIDE

### Stock Tools for Ceramic Abrasive Wheels

**SG/Ceramic** Engineered for use on ceramic (SG, NQ, Targa, etc.) wheels but may also provide significant benefits when used on conventional abrasive products. These tools are furnished with top quality specially selected diamonds.

**BCSG/Ceramic** Economical alternative to an “SG” tool. Best choice when a disposable tool is preferred.

### Stock Tools for Conventional Abrasive Wheels

**NS** Engineered for use on conventional abrasives. These high-quality, value-priced tools can be used for a variety of dressing applications.

**BC** Economical alternative to an “NS” tool. Best choice when a disposable tool is preferred.

### SELECTING THE CORRECT SINGLE POINT TOOL:

- Identify the wheel abrasive type: A/O, S/C or Ceramic
- Determine the wheel diameter – to select the optimum carat weight
- Determine the tool holder size – to select appropriate shank diameter

### EXAMPLES OF SINGLE POINT TOOL SELECTION

<b>Conventional Wheel Spec:</b>	32A46-IVBE 7" x 1/2" x 1-1/4" Customer's machine has a 7/16" tool holder
<b>Tool Selections:</b>	Resettable: NS2M7 or NSUD2 (Indexable) Non-Resettable: BC2M7 or BCUD2 (Indexable)
<b>Ceramic Wheel Spec:</b>	5SG60-JVS or 5NQ60-IVS 10" x 1" x 3" Customer's machine has a 3/8" tool holder
<b>Tool Selections:</b>	Resettable: SG3M6 Non-Resettable: BCSG3M6

### DETERMINING THE BEST VALUE

- Remember that diamonds are a rare commodity—the larger the stone and the better the quality, the higher the initial cost. The key to successful diamond tool productivity and use is based on the “cost per dress.” Normally, higher quality diamonds and a proactive resetting program will result in the lowest “cost per dress.”
- In those situations where a resetting program is not feasible or low initial cost is the primary purchasing consideration, Norton offers a complete line of non-resettable tools.

### STOCK SINGLE POINT TOOL MARKING SYSTEM

DIAMOND QUALITY	DIAMOND SIZE	SHANK DESIGN	SHANK DIAMETER
<b>SG/Ceramic</b>	1 = 1/5 (.20) carat	M	6 = 3/8"
<b>BCSG/Ceramic</b>	2 = 1/4 (.25) carat	J	7 = 7/16"
<b>NS</b>	3 = 1/3 (.33) carat		
<b>BC</b>	5 = 1/2 (.50) carat		
	7 = 3/4 (.75) carat		
	10 = 1 carat		

EXAMPLE: NS 2 M 6

### NON-STOCK SINGLE POINT TOOL MARKING SYSTEM

TOOL TYPE	DIAMOND SIZE	DIAMOND QUALITY	SHANK DESIGN	SHANK DIAMETER
<b>SP</b>	1 = 1/5 (.20) carat	AA	M	6 = 3/8"
	2 = 1/4 (.25) carat	A	J	7 = 7/16"
	3 = 1/3 (.33) carat	NS		
	5 = 1/2 (.50) carat	BC		
	7 = 3/4 (.75) carat			
	10 = 1 carat			

EXAMPLE: SP 5 A M 7

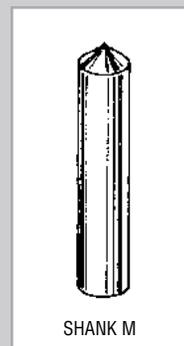
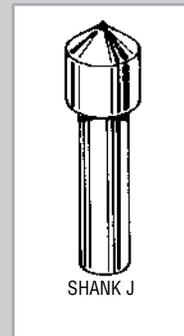

CONTACT YOUR NORTON REPRESENTATIVE FOR ALL YOUR NON-STOCK, CUSTOM CONFIGURATION QUESTIONS, REQUESTS FOR QUOTES, ETC.

## SINGLE POINT TOOLS FOR TRUING/DRESSING CERAMIC ABRASIVES

### SG/CERAMIC SINGLE POINT TOOLS

FEATURES	BENEFITS
<ul style="list-style-type: none"> <li>■ Specially selected broad-shaped, diamond</li> <li>■ Each diamond is hand selected for stone shape, quality and structural integrity</li> <li>■ Multi-purpose</li> </ul>	<ul style="list-style-type: none"> <li>■ Withstands the increased grinding pressures of ceramic abrasives</li> <li>■ Consistent tool performance</li> <li>■ Accommodates most straight dressing and simple form dressing applications</li> <li>■ Stands up to ceramic (SG, NQ, TG, etc.) abrasive sharpness; can also be used to dress conventional abrasives</li> </ul>



#### BEST

#### RESETTABLE SG/CERAMIC SINGLE POINT TOOLS

- Norton high quality diamond and a proactive resetting program will result in the lowest dressing cost per part

#### GOOD

#### NON-RESETTABLE BCSG/CERAMIC SINGLE POINT TOOLS

- The best selection when a resetting program is not feasible or low initial cost is the primary purchasing consideration

WHEEL DIAMETER	TOOL CARAT WEIGHT	TOOL DIAMETER	TOOL LENGTH	BEST		GOOD	
				PRODUCT #	3 SETTABLE PTS (2 RESETS) UPC #	PRODUCT #	NON-RESETTABLE UPC #
<b>STOCK SINGLE POINT TOOLS FOR TRUING/DRESSING CERAMIC ABRASIVES</b>							
Up to 7"	1/4 (.25)	3/8"	2"	SG2M6	66260195365	BCSG2M6	66260157007
		7/16"	2"	SG2M7	66260195366	BCSG2M7	66260156905
8" to 10"	1/3 (.33)	3/8"	2"	SG3M6	66260195367	BCSG3M6	66260157008
		7/16"	2"	SG3M7	66260195368	BCSG3M7	66260156906
11" to 14"	1/2 (.50)	3/8"	2"	SG5M6	66260195369	BCSG5M6	66260157009
		7/16"	2"	SG5M7	66260195370	BCSG5M7	66260156907
15" to 20"	3/4 (.75)	3/8"	2"	SG7M6	66260195371	BCSG7M7	66260156908
		7/16"	2"	SG7M7	66260195372	BCSG10M7	66260157010
21"+	1 (1.00)	7/16"	2"				

#### WHEEL FORMS DRESSED BY THESE TOOLS



STRAIGHT TAPERED CONVEX

NON-STOCK SG RESETTABLE SINGLE POINT TOOLS ARE ALSO AVAILABLE.  
STANDARD PACKAGE = 1 TOOL

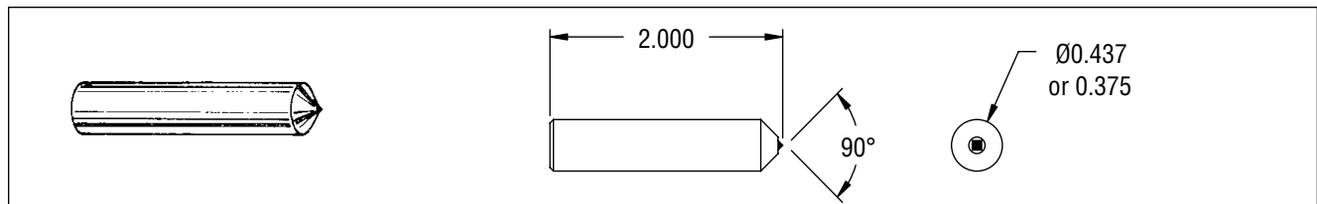

## SINGLE POINT TOOLS FOR TRUING/DRESSING CONVENTIONAL ABRASIVES

### CONVENTIONAL SINGLE POINT TOOLS

FEATURES	BENEFITS
<ul style="list-style-type: none"> <li>■ Consistent diamond structure and shape</li> <li>■ Well defined, sharp diamond point</li> <li>■ Steeper 60 degree included angle head design</li> </ul>	<ul style="list-style-type: none"> <li>■ Repeatable dressing performance</li> <li>■ Durable; maximum cost effectiveness for dressing conventional abrasives</li> <li>■ Greater machine and part clearance produce forms with tighter tolerances</li> </ul>



#### BEST

#### RESETTABLE NS (NORTON STANDARD) SINGLE POINT TOOLS

- High quality diamonds, value priced
- Selection of the correct tool and a proactive resetting program will result in the lowest dressing cost per part

#### GOOD

#### NON-RESETTABLE BC SINGLE POINT TOOLS

- The best selection when a resetting program is not feasible or low initial cost is the primary purchasing consideration

## SINGLE POINT TOOLS FOR TRUING/DRESSING CONVENTIONAL ABRASIVES (CONTINUED)

WHEEL DIAMETER	TOOL CARAT WEIGHT	TOOL DIAMETER	BEST		BETTER		BETTER		GOOD	
			PRODUCT #	UPC #	PRODUCT #	UPC #	PRODUCT #	UPC #	PRODUCT #	UPC #
<b>STOCK SINGLE POINT TOOLS FOR TRUING/DRESSING CONVENTIONAL ABRASIVES</b>										
Internal Wheel	1/5 (.20)	3/8"							BC1M6	66260195021
Up to 7"	1/4 (.25)	3/8"					NS2M6	66260195116	BC1M7	66260195022
8" to 10"	1/3 (.33)	3/8"					NS2M7	66260195117	BC2M6	66260195000
11" to 14"	1/2 (.50)	3/8"					NS3M6	66260195121	BC2M7	66260195001
15" to 20"	3/4 (.75)	3/8"					NS3M7	66260195122	BC3M6	66260195002
21" +	1 (1.00)	3/8"					NS5M6	66260195126	BC3M7	66260195003
		7/16"					NS5M7	66260195127	BC5M6	66260195004
		7/16"					NS7M7	66260195132	BC5M7	66260195005
		7/16"					NS7J7	66260195130	BC7M6	66260195006
		7/16"					NS10M6	66260195136	BC7M7	66260195007
		7/16"					NS10M7	66260195137	BC10M6	66260195008
		7/16"					NS10J7 *	66260195135	BC10M7	66260195009

\* J-SHANK TOOLS ARE AVAILABLE IN 7/16" DIAMETER WITH 5/8" HEAD

### NON-STOCK SINGLE POINT TOOLS FOR TRUING/DRESSING CONVENTIONAL ABRASIVES

Internal	1/5 (.20)	3/8"	SP1AAM6	66260195990	SP1AM6	66260196014				
Wheels		7/16"	SP1AAM7	66260195991	SP1AM7	66260196015				
Up to 7"	1/4 (.25)	3/8"	SP2AAM6	66260195994	SP2AM6	66260196018				
		7/16"	SP2AAM7	66260195995	SP2AM7	66260196019				
8" to 10"	1/3 (.33)	3/8"	SP3AAM6	66260195998	SP3AM6	66260196022				
		7/16"	SP3AAM7	66260195999	SP3AM7	66260196023				
11" to 14"	1/2 (.50)	3/8"	SP5AAM6	66260196002	SP5AM6	66260196026				
		7/16"	SP5AAM7	66260196003	SP5AM7	66260196027				
15" to 20"	3/4 (.75)	3/8"	SP7AAM6	66260196006	SP7AM6	66260145772				
		7/16"	SP7AAM7	66260196007	SP7AM7	66260145778				
21" +	1 (1.00)	3/8"	SP10AAM6	66260160468	SP10AM6	66260196034				
		7/16"	SP10AAM7	66260196011	SP10AM7	66260196035				

NON-STOCK "AA" AND "A" DIAMOND QUALITY LEVEL RESETTABLE PRODUCTS ARE TYPICALLY USED FOR PRECISION APPLICATIONS.

ADDITIONAL NON-STOCK AVAILABILITY:

- NON-STOCK TOOLS WITH A "J" SHANK ARE AVAILABLE IN 7/16" DIAMETER WITH 5/8" HEAD
- LARGER CARAT WEIGHT DIAMONDS

STANDARD PACKAGE = ONE TOOL

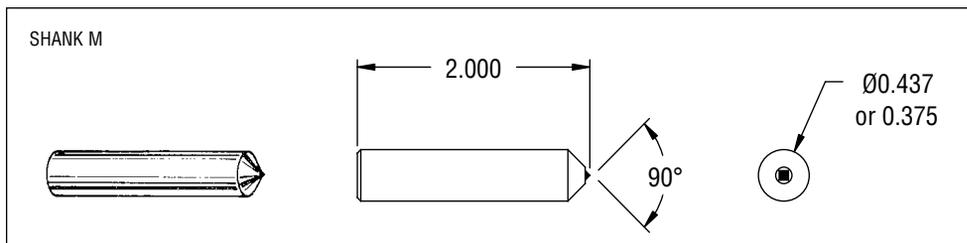
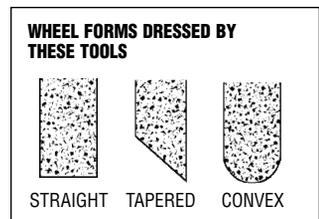
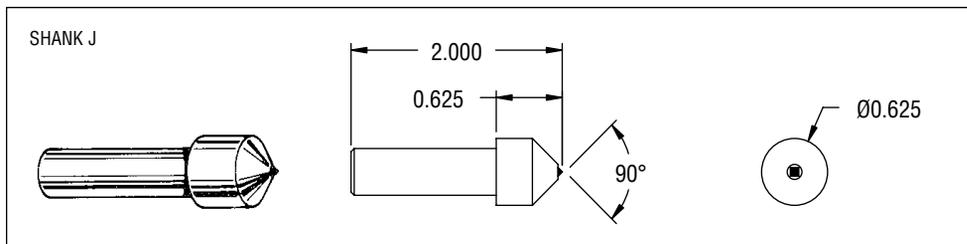

CONTACT YOUR NORTON REPRESENTATIVE FOR ALL YOUR NON-STOCK, CUSTOM CONFIGURATION QUESTIONS, REQUESTS FOR QUOTES, ETC.

## INDEXABLE SINGLE POINT TOOLS

Indexable tools are specifically designed to alleviate any misalignment issues and are the tools of choice for CNC grinders. They feature a two-part construction with the head and shank as separate pieces. After the initial installation, operators simply turn the indexable head with a wrench, while the tool shank remains secure (and aligned) in the tool holder.

### INDEXABLE SINGLE POINT TOOLS

FEATURES	BENEFITS
<ul style="list-style-type: none"> <li>Easily turned without removing tool from the holder</li> </ul>	<ul style="list-style-type: none"> <li>Easier for operators to turn than conventional tools increasing frequency of beneficial tool turning</li> <li>Extended life; less downtime and increased productivity</li> </ul>
<ul style="list-style-type: none"> <li>U-Dex-It and Mini-Dex tools have a 60° included angle head design</li> </ul>	<ul style="list-style-type: none"> <li>Provides additional form versatility through machine and part clearance</li> <li>Excellent choice for regulating wheels</li> </ul>



## INDEXABLE SINGLE POINT TOOLS FOR TRUING/DRESSING CERAMIC ABRASIVES

### GOOD

#### NON-RESETTABLE BCSGUD/CERAMIC U-DEX-IT INDEXABLE SINGLE POINT TOOLS

- These U-Dex-It tools contain specially selected diamonds to withstand increased ceramic (SG, Norton Quantum NQ, Targa TG, etc.) grinding pressures
- Ideal for centerless grinders; the head can be turned, using standard 5/8" wrench, through the hole in the side of the wheel guard without removing the guard
- The best selection when a resetting program is not feasible or low initial cost is the primary purchasing consideration

				GOOD	
WHEEL DIAMETER	TOOL CARAT WEIGHT	TOOL SIZE	PRODUCT #	NON-RESETTABLE UPC #	
<b>STOCK INDEXABLE SINGLE POINT TOOLS FOR TRUING/DRESSING CERAMIC ABRASIVES</b>					
Up to 7"	1/4 (.25)	7/16" x 1-7/16" with 5/8" head	BCSGUD2	66260162669	
8" to 10"	1/3 (.33)	7/16" x 1-7/16" with 5/8" head	BCSGUD3	66260162668 +	
11" to 14"	1/2 (.50)	7/16" x 1-7/16" with 5/8" head	BCSGUD5	66260159894	

#### STANDARD PACKAGE = ONE TOOL

+ Available as stock while supplies last, then available as non-stock.

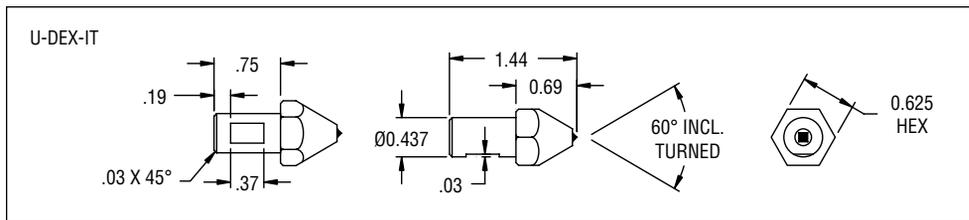

#### WHEEL FORMS DRESSED BY THESE TOOLS

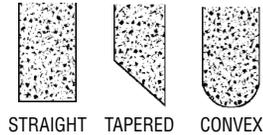

## INDEXABLE SINGLE POINT TOOLS FOR TRUING/DRESSING CONVENTIONAL ABRASIVES

### BETTER

#### RESETTABLE NORTON STANDARD NSUD U-DEX-IT INDEXABLE SINGLE POINT TOOLS

- High quality diamonds, value priced
- Ideal for centerless grinders; the head can be turned, using standard 5/8" wrench, through the hole in the side of the wheel guard without removing the guard
- Selection of the correct tool and a proactive resetting program will usually result in the lowest dressing cost per part

### BETTER

#### RESETTABLE NORTON STANDARD NSMD MINI-DEX INDEXABLE SINGLE POINT TOOLS

- High quality diamonds, value priced
- Use a standard 7/16" wrench to turn; designed for internal, bearing race and twist drill flute machines
- Selection of the correct tool and a proactive resetting program will usually result in the lowest dressing cost per part

### GOOD

#### NON-RESETTABLE BCUU U-DEX-IT INDEXABLE SINGLE POINT TOOLS

- Ideal for centerless grinders; the head can be turned, using standard 5/8" wrench, through the hole in the side of the wheel guard without removing the guard
- The best selection when a resetting program is not feasible or low initial cost is the primary purchasing consideration

## INDEXABLE SINGLE POINT TOOLS FOR TRUING/DRESSING CONVENTIONAL ABRASIVES (CONTINUED)

WHEEL DIAMETER	TOOL CARAT WEIGHT	TOOL SIZE	BETTER		GOOD	
			PRODUCT #	2 SETTABLE PTS (1 RESET) UPC #	PRODUCT #	NON-RESETTABLE UPC #
<b>STOCK INDEXABLE SINGLE POINT TOOLS FOR TRUING/DRESSING CONVENTIONAL ABRASIVES</b>						
Up to 7"	1/4 (.25)	7/16" x 1-7/16" with 5/8" head 1/4" x 1-3/16" with 7/16" head	NSMD2	66260195171	BCUD2	66260195023
8" to 10"	1/3 (.33)	7/16" x 1-7/16" with 5/8" head 1/4" x 1-3/16" with 7/16" head	NSUD3	66260195162	BCUD3	66260195024
			NSMD3	66260195172		
11" to 14"	1/2 (.50)	7/16" x 1-7/16" with 5/8" head 1/4" x 1-3/16" with 7/16" head	NSUD5	66260195163	BCUD5	66260195025
			NSMD5	66260195173 +		
15" to 20"	3/4 (.75)	7/16" x 1-7/16" with 5/8" head	NSUD7	66260195164		

STANDARD PACKAGE = ONE TOOL

+ AVAILABLE AS STOCK WHILE SUPPLIES LAST, THEN AVAILABLE AS NON-STOCK.

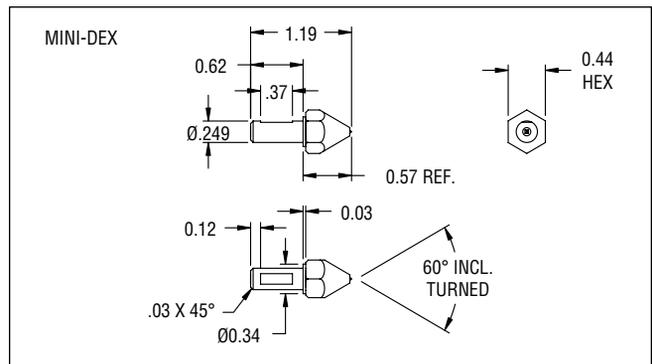
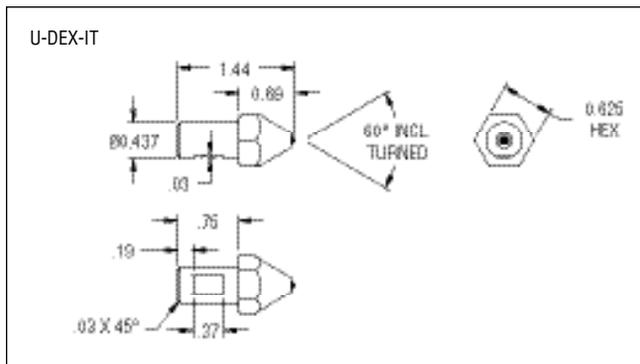

## INTERNAL GRINDING TOOLS

### BEST RESETTABLE INTERNAL GRINDING TOOLS

■ Q style shank is used on a Heald internal grinder (resettable).



MACHINE TYPE	CARAT WEIGHT	SHANK DIAMETER	TOOL LENGTH	BEST	
				PRODUCT #	2 SETTABLE PTS (1 RESET) UPC #
<b>STOCK INTERNAL GRINDING TOOLS</b>					
Heald	1/5 (.20)	7/16"	1"	NI21Q7	66260195180

STANDARD PACKAGE = 1 TOOL

#### WHEEL FORMS DRESSED BY THESE TOOLS

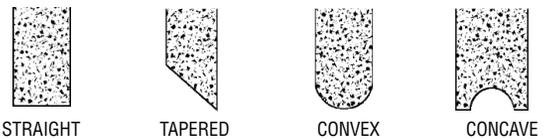

#### SHANK Q FOR HEALD MACHINE

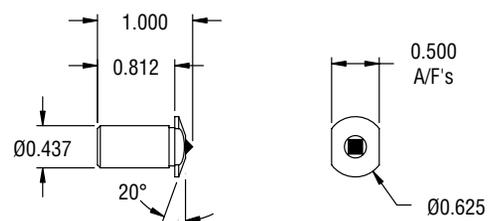



## THREAD GRINDING TOOLS

**BEST**

### RESETTABLE SG/CERAMIC THREAD GRINDING TOOLS

- These wheels are used on J & L and Excello thread grinding machines to accurately dress the grinding wheels that form the desired thread configuration (non-resettable).



MACHINE TYPE	SHANK DIAMETER	TOOL LENGTH	INCLUDED ANGLE	MAX RADIUS ON POINT	BEST	
					PRODUCT #	NON-RESETTABLE UPC #
<b>STOCK THREAD GRINDING TOOLS</b>						
J & L	1/4"	1"			38RL4	66260195100
J & L	1/4"	1"	80°	.010"	NT1L4	66260195187
EXCELLO	3/8"	1-5/8"	60°	.010"	NT106	66260195190
<b>NON-STOCK THREAD GRINDING TOOLS</b>						
J & L	1/4"	1"	80°	.010"	NX-57475	66260195185
EXCELLO	3/8"	1-5/8"	60°	.010"	48-4105	66260195188

STANDARD PACKAGE = 1 TOOL

WHEEL FORMS DRESSED BY THESE TOOLS



STRAIGHT



TAPERED

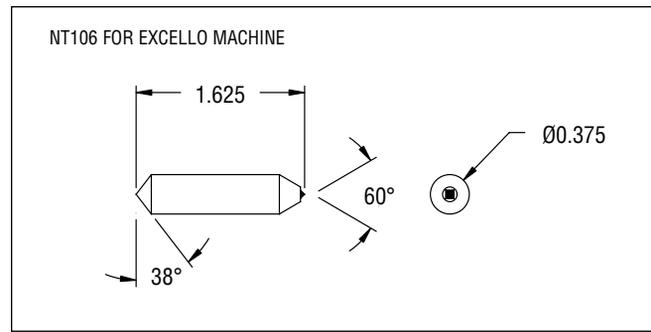
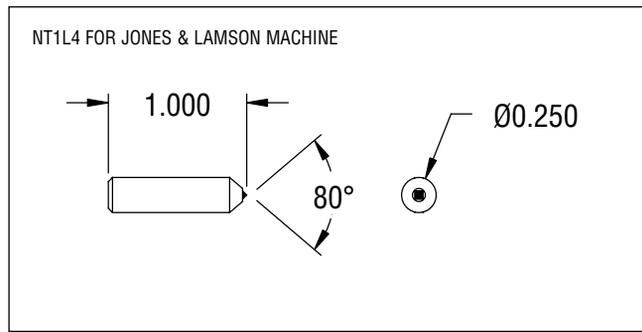

CONTACT YOUR NORTON REPRESENTATIVE FOR ALL YOUR NON-STOCK, CUSTOM CONFIGURATION QUESTIONS, REQUESTS FOR QUOTES, ETC.

## TOOLROOM TOOLS

Norton Toolroom Dressing Tools are primarily used on surface grinders to form the grinding wheel to an exact concave or convex radius. Although some tools are designed for use on a specific machine, many radius tools can be used on any grinder having the correct set-up.

Used generally on 8" diameter and smaller vitrified toolroom wheels, Norton offers a selection of phono-point, conventional radius, and full ball radius tools.

### WHEEL FORMS DRESSED BY THESE TOOLS

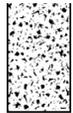

STRAIGHT



CONCAVE



CONVEX



MULTI-ANGLED



## PHONO-POINT TOOLS

For general toolroom concave and convex dressing on small diameter grinding wheels. Not resettable.

INCLUDED ANGLE	SHANK DIAMETER	TOOL LENGTH	BETTER		GOOD	
			PRODUCT #	NON-RESETTABLE UPC #	PRODUCT #	NON-RESETTABLE UPC #
<b>STOCK PHONO-POINT TOOLS</b>						
60°	1/8"	1"	NP1M2	66260195225	BCPP-60	66260195017
	3/16"		NP1M3	66260195226		
	1/4"		NP1M4	66260195227		
75°	1/8"	1"	NP2M2	66260195228	BCPP-75	66260195018
	1/4"		NP2M4	66260195230		
90°	1/8"	1"	NP3M2	66260195231	BCPP-90	66260195019
	3/16"		NP3M3	66260195232		
	1/4"		NP3M4	66260195233		

STANDARD PACKAGE = ONE TOOL

### WHEEL FORMS DRESSED BY THESE TOOLS



CONVEX



CONCAVE



CONVEX

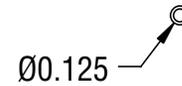
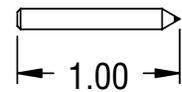

TYPICAL WHEEL FORMS

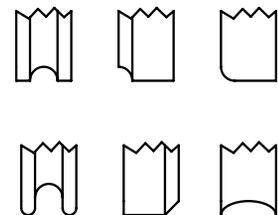

## TECHtip

### HOW TO USE TOOLROOM TOOLS

- We recommend dressing with coolant. However, if dressing totally dry, allow three to five seconds between passes for diamond to cool.
- Use extremely light cuts from .0002" to .001" maximum.
- Rotate tool if the application and set-up allow.
- Full Ball Radius Tools should be returned for relap after minimum wear.

## SPECcheck

### PHONO-POINT TOOL MARKING SYSTEM

TOOL TYPE	INCLUDED ANGLE ON DIAMOND	SHANK STYLE	SHANK DIAMETER
NP	1 = 60°	M	2 = 1/8"
BCPP	2 = 75°		3 = 3/16"
	3 = 90°		4 = 1/4"

EXAMPLE: NP 1 M 3

**RADIUS TOOLS**

**Concave Radius Tools**

This line offers a specially-shaped single point diamond, designed for forming concave radii on small diameter grinding wheels. Not resettable.

**Convex Radius Tools**

This line offers a specially-shaped single point diamond, designed for forming convex radii on small diameter grinding wheels. Not resettable.

**Half-Circle Concave Radius Tools (Available as Non-stock Only)**

This line offers a specially-shaped diamond set in the side of the shank for forming half-circle radii on small diameter grinding wheels. The tool is rotated to form the radius. Commonly called a “rat tail dresser.” Not resettable.

RADIUS SIZE TO BE DRESSED	SHANK DIAMETER	BEST			GOOD		
		TOOL LENGTH	PRODUCT #	NON-RESETTABLE UPC #	TOOL LENGTH	PRODUCT #	NON-RESETTABLE UPC #
<b>STOCK CONCAVE RADIUS TOOLS</b>							
.010" to .015"	3/8"	2"	NR1P6	66260195210			
.016" to .020"	3/8"	2"	NR2P6	66260195211			
.021" to .032"	3/8"	2"	NR3P6	66260195212			
.033" to .062"	3/8"	2"	NR4P6	66260195213	2"	BCRD	66260195016
.063" to .125"	3/8"	2"	NR5P6	66260195214	2"	BCRD	66260195016
.126" to .250"	3/8"	2"	NR6P6	66260195215	2"	BCRD	66260195016
<b>STOCK CONVEX RADIUS TOOLS</b>							
.020" to .125"	3/8"	2"	NR2M6	66260195216			
.126" to .250"	3/8"	2"	NR12M6	66260195217			
.251" to .500"	3/8"	2"	NR25M6	66260195218			
<b>NON-STOCK HALF-CIRCLE CONCAVE RADIUS TOOLS</b>							
.032"	3/8"	2-1/2"	NR3N6	66260195219 *			
.062"	3/8"	2-1/2"	NR6N6	66260195220 *			
.125"	3/8"	2-1/2"	NR12N6	66260195221 *			

STANDARD PACKAGE = ONE TOOL

\* NON-STOCK; CONTACT YOUR NORTON REPRESENTATIVE FOR CURRENT LEAD-TIMES.

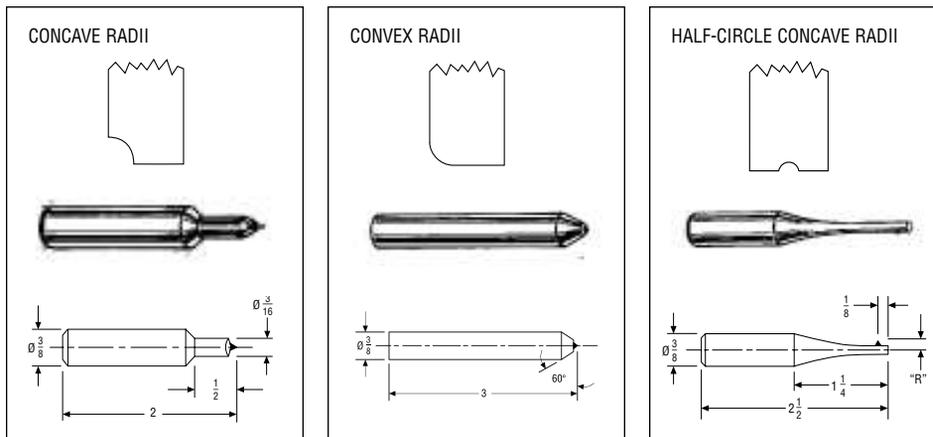

## FULL BALL RADIUS TOOLS

For precision plunge form dressing, Full Ball Radius tools are designed to plunge dress a concave radius in the center of a grinding wheel. Frequent turning of the tool will maintain accuracy over a long period of use. Can be relapped.

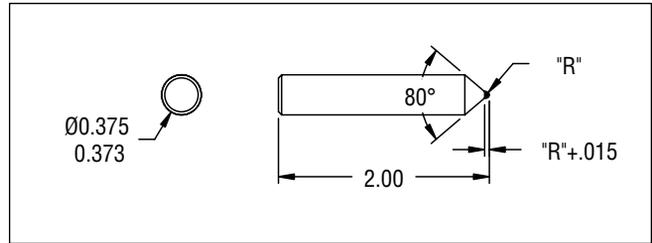

RADIUS SIZE TO BE DRESSED	SHANK DIAMETER	TOOL LENGTH	BETTER	
			PRODUCT #	RELAPPABLE UPC #
<b>NON-STOCK FULL BALL RADIUS TOOLS</b>				
.010"	3/8"	2"	FB10	66260195255
.015"	3/8"	2"	FB15	66260195256
.020"	3/8"	2"	FB20	66260195257
.025"	3/8"	2"	FB25	66260195258
.030"	3/8"	2"	FB30	66260195259
.035"	3/8"	2"	FB35	66260195260
.040"	3/8"	2"	FB40	66260195261
.045"	3/8"	2"	FB45	66260195262
.050"	3/8"	2"	FB50	66260195263

LARGER RADIUS SIZES ARE AVAILABLE UPON REQUEST.  
STANDARD PACKAGE = ONE TOOL

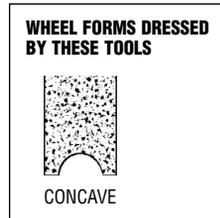

## SPECcheck

### FULL BALL RADIUS TOOL MARKING SYSTEM

TOOL TYPE	RADIUS REQUIRED ON DIAMOND IN THOUSANDS OF AN INCH
FB	10 = .010"
	15 = .015"
	20 = .020"
	25 = .025"
	30 = .030"
	35 = .035"
	40 = .040"
	45 = .045"
	50 = .050"

EXAMPLE: FB 25

**CONTACT YOUR NORTON REPRESENTATIVE FOR ALL YOUR NON-STOCK, CUSTOM CONFIGURATION QUESTIONS, REQUESTS FOR QUOTES, ETC.**

## MULTI-POINT (GRIT) TOOLS

Since Norton conventional and high-performance Multi-Point tools never need turning or resetting, they are the most economical way to accomplish a variety of straight, tapered, and step dressing operations on all sizes of cylindrical, centerless, surface, and toolroom grinding wheel applications.

### WHEEL FORMS DRESSED BY THESE TOOLS



STRAIGHT



TAPERED



## NORTON MULTI-POINT TOOLS

### FEATURES

- Uniformly distributed diamonds in a tough, durable matrix
- Fresh, multiple diamond points exposed in truing operation; no turning or resetting required
- Overall diamond weight exceeds equivalent single point tool

### BENEFITS

- Consistent performance throughout tool life
- Faster, more consistent straight face dressing with maximum efficiency and longer tool life than single point tools
- The most economical way to dress straight and tapered forms

## TECHtip

### MULTI-POINT TOOLS – STRAIGHT FACE DRESSING AND TRUING

- Most multi-point tools are used for straight face dressing.
- Tool should have full face contact with the wheel.
- With new tool, 3–5 passes at .005" per pass should be taken to expose diamonds.
- Infeed per pass .001" - .002"
- Use coolant whenever possible.
- Use appropriate lead (and traverse rate).
- Contact your Norton representative for proper tool selection for Targa wheels.

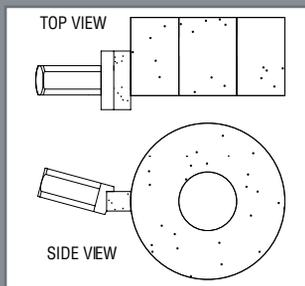

### MULTI-POINT DRESS TRAVERSE RATE

Select a Lead Value based on desired Surface Finish and run the formula below.

FINISH	LEAD VALUE (PER WHEEL REVOLUTIONS)
For Coarse Finish (approx. 64 RMS)	.023" to .030" (.58mm – .76mm)
For Medium Finish (approx. 32 RMS)	.013" to .022" (.33mm – .57mm)
For Fine Finish (approx. 16 RMS)	.006" to .012" (.15mm – .33mm)

$$\text{LEAD VALUE} \times \text{WHEEL SPEED (RPM)} = \text{TRAVERSE RATE IN INCHES/MINUTE}$$

- Slower traverse rates result in a closed wheel face that produces less stock removal and improved workpiece finish.
- Faster traverse rates result in an open wheel face that produces greater stock removal and a rougher workpiece finish.



It is the user's responsibility to refer to and comply with ANSI B7.1

## SPECcheck

### SELECTING THE CORRECT MULTI-POINT TOOL

- Identify the wheel abrasive type: ceramic (SG, Norton Quantum NQ, Targa TG), A/O, or S/C
- Determine the wheel diameter and grit size
- Determine the tool's approach angle to the centerline of the wheel
- Identify the tool holder diameter
- Use 1E shape for angular wheel slide, cylindrical grinding and for shoulder or step truing

### EXAMPLES OF MULTI-POINT TOOL SELECTION

**Conventional Wheel Spec:** 32A46-IVBE 7" x 1/2" x 1-1/4"  
**Tool Selection:** Customer's machine has a 3/8" tool holder 1R6J6

**Ceramic Wheel Spec:** 5SG60-JVS or 5NQ60-IVS 10" x 1" x 3"  
**Tool Selections:** Customer's machine has a 7/16" tool holder SG1R6J7

# SPECcheck



## MULTI-POINT TOOL DIAMOND SECTION SPECIFICATIONS

SHAPE	WIDTH	LENGTH	DEPTH	TOOL APPROACH ANGLE TO WHEEL	FOR WHEEL DIAMETER
1A	1/4"	3/4"	5/16"	0°	Over 20"
2A	1/4"	1/2"	3/8"	0°	15" – 20"
3A	5/32"	3/8"	1/4"	0°	Over 20"
1E	5/32"	3/8"	5/16"	–	
2E	1/4"	1/2"	1/2"	–	20" x 2" and up
1R	1/4" Round		1/4"	0°	Up to 10"
2R	3/8" Round		3/8"	0°	11" – 14"

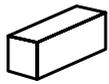

A SHAPE IS USED PRIMARILY FOR STRAIGHT FACE DRESSING.

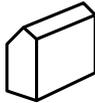

E SHAPE (DOUBLE ANGLE TOP FACE) IS USED FOR STANDARD N-FACE WHEELS, ANGULAR WHEELS, FACE AND SIDE TRUING OF CYLINDRICAL WHEELS, AND IN STEP DRESSING.



R SHAPE IS USED FOR STRAIGHT FACE DRESSING WHERE THE TOOL HOLDER IS PERPENDICULAR TO THE WHEEL FACE (NO DRAG ANGLE), AND ON THREAD GRINDING MACHINES.

## MULTI-POINT TOOL MARKING SYSTEM

DIAMOND SHAPE	TOOL DIAMOND SIZE	TO DRESS GRINDING WHEELS WITH GRIT SIZE OF:	SHANK DESIGN	SHANK DIAMETER
1A	4 =	46 grit	See the following pages for shank configurations	6 = 3/8"
2A	6 =	54 - 100 grit		7 = 7/16"
3A	8 =	120 - 150 grit		8 = 1/2"
1E	12 =	150+ grit		
2E	14 =	Special Applications		
1R				
2R				

EXAMPLE: 1A 6 A 7

## MULTI-POINT TOOLS FOR TRUING/DRESSING CERAMIC ABRASIVES

### Tool Shape and Shank Availability

#### SG1R

For general purpose dressing of toolroom, cylindrical, and surface grinding wheels up to 10" in diameter.

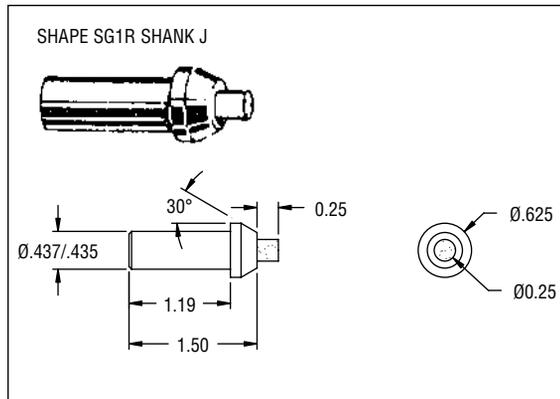
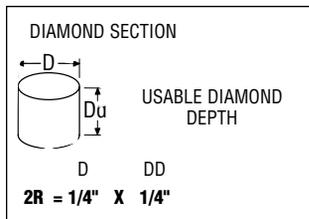

#### SG2R

For use on cylindrical, centerless, and surface grinding wheels 11" to 14" in diameter.

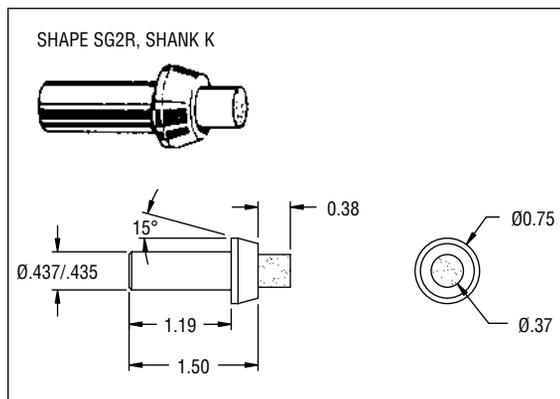
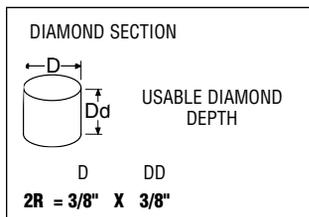

## TECHtip

- To optimize applications using ceramic abrasives/tools, normal dressing parameters must change. Significant reductions in the amount of infeed and frequency of dress will result in significantly lower cost per part ground.
- While all Norton SG/Ceramic tools have been designed to improve the efficiency of ceramic grinding applications, they can also offer significant benefits in many applications using conventional abrasives.
- When first using a Norton SG/ Ceramic tool, make 3 to 5 passes at .005" infeed to ensure full face contact between the dressing tool and wheel face.
- Reduce normal dressing infeed by half. Do not exceed infeed of .002" per pass.
- The lead selection should be between .006"-.030" per wheel revolution. Faster traverse with a Norton SG/Ceramic tool generally provides an open wheel face that can maximize productivity of the ceramic abrasive.

## MULTI-POINT TOOLS FOR TRUING/DRESSING CERAMIC ABRASIVES (CONTINUED)

### Tool Shape and Shank Availability

#### SG2A

For use on 15" to 20" diameter cylindrical, surface or centerless grinding wheels.

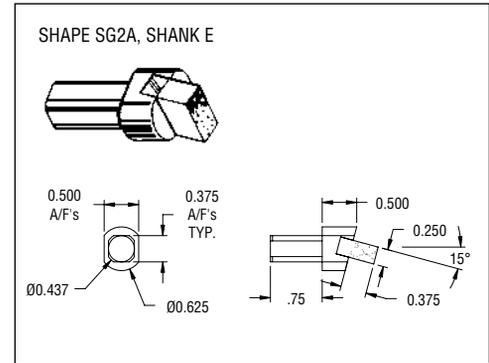
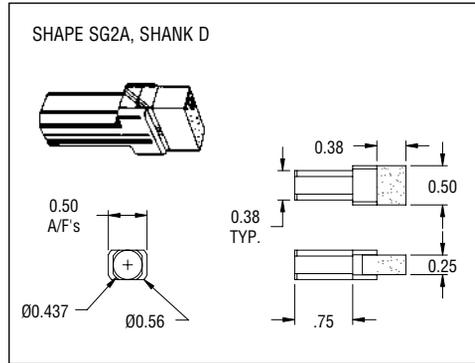
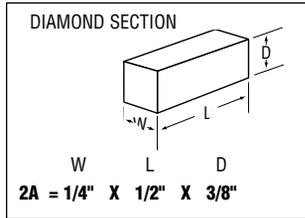

#### SG1A

For use on cylindrical, centerless, and surface grinding wheels over 20" in diameter

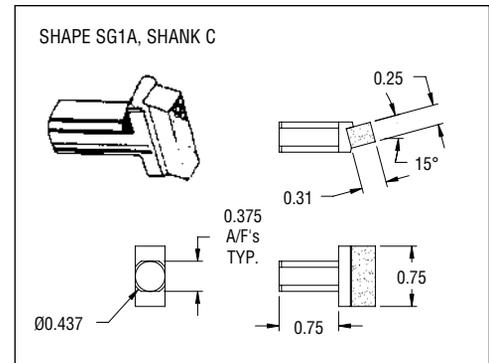
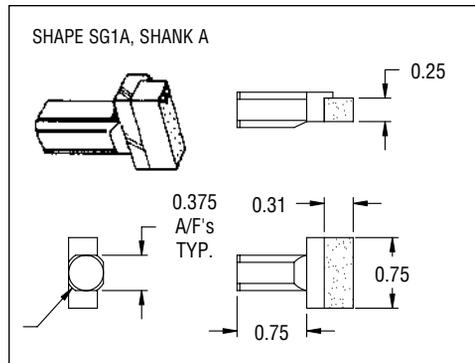
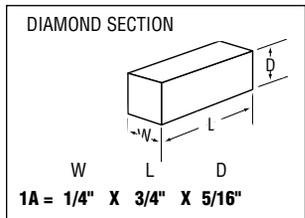

### BEST

### SG/CERAMIC MULTI-POINT TOOLS

- Designed specifically for use on ceramic (SG, Norton Quantum NQ, Targa TG. etc.) abrasives, SG tools contain a higher diamond concentration to withstand the increased grinding pressures generated by the ceramic abrasives. These tools have improved life and dress quality; they can also offer significant benefits in many applications using conventional abrasives.

WHEEL DIAMETER	WHEEL GRIT SIZE	TOOL APPROACH ANGLE	TOOL DIAMETER	BEST	
				CERAMIC ABRASIVES PRODUCT #	UPC #
<b>STOCK MULTI-POINT TOOLS FOR TRUING/DRESSING CERAMIC ABRASIVES</b>					
Up to 10"	54 to 100	0°	7/16"	SG1R6J7	66260195377
11" to 14"	54 to 100	0°	7/16"	SG2R6K7	66260195378
15" to 20"	54 to 100	0°	7/16"	SG2A6D7	66260195375
		15°	7/16"	SG2A6E7	66260195376
21" +	54 to 100	0°	7/16"	SG1A6A7	66260195373
		15°	7/16"	SG1A6C7	66260195374

STANDARD PACKAGE = ONE TOOL

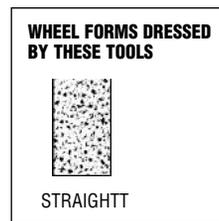

CONTACT YOUR NORTON REPRESENTATIVE FOR ALL YOUR NON-STOCK, CUSTOM CONFIGURATION QUESTIONS, REQUESTS FOR QUOTES, ETC.

## MULTI-POINT TOOLS FOR TRUING AND STRAIGHT DRESSING CONVENTIONAL ABRASIVES

### Tool Shape and Shank Availability

#### 1R

For general purpose dressing of toolroom, cylindrical, and surface grinding wheels up to 10" in diameter.

**Diamond Size Availability: 6, 8**

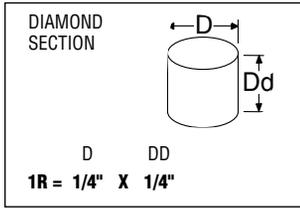

#### 2R

For use on cylindrical, centerless and surface grinding wheels 11" to 14" in diameter.

**Diamond Size Availability: 4, 6, 8**

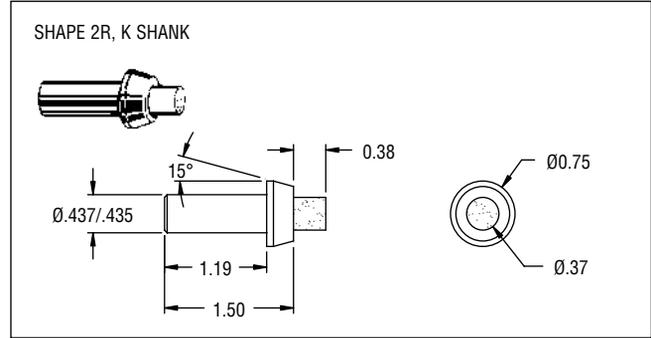
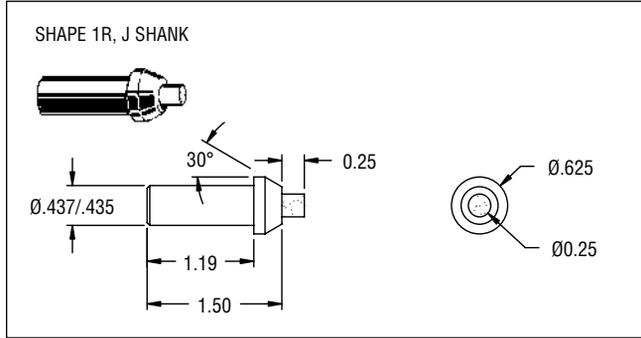
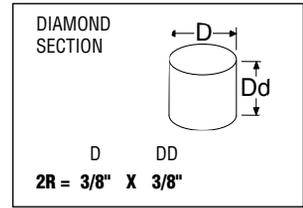

#### 2A

For use on 15" to 20" cylindrical, surface, and centerless wheels.

**Diamond Size Availability: 4, 6, 8**

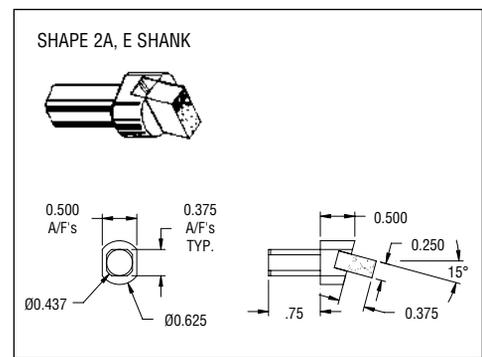
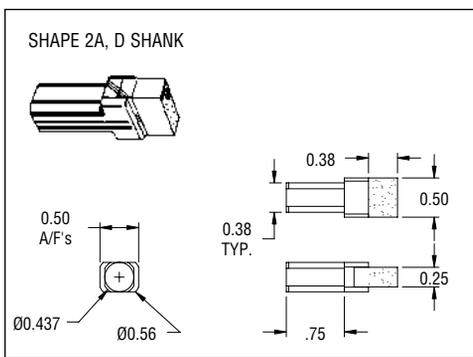
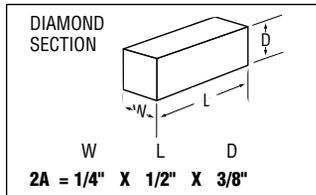

#### 1A

For use on cylindrical and surface grinding wheels over 20" in diameter.

**Diamond Size Availability: 4, 6, 8**

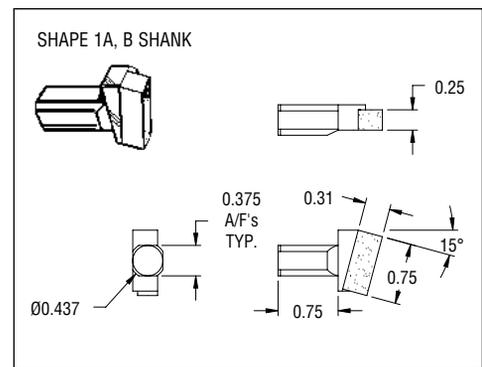
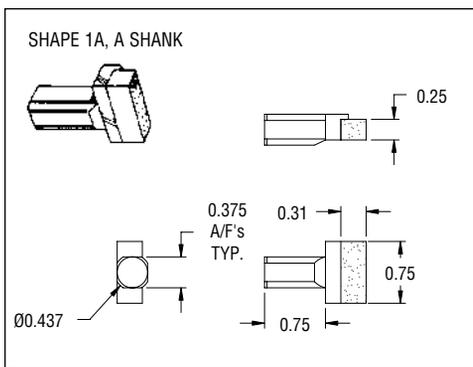
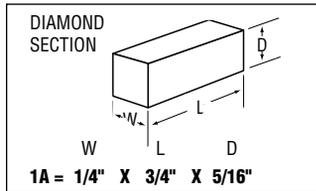

### DIAMOND SIZE KEY

DIAMOND SIZE	TO DRESS WHEEL WITH GRIT SIZE OF:
4	46
6	54 - 100
8	120 - 150

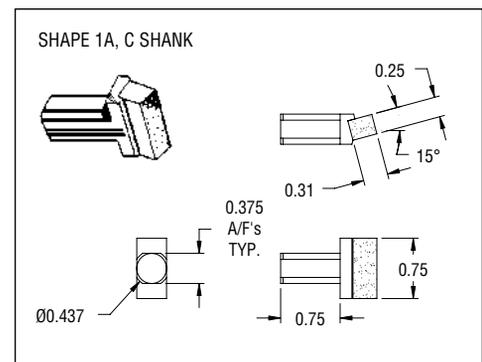



## MULTI-POINT TOOLS FOR TRUING AND STRAIGHT DRESSING CONVENTIONAL ABRASIVES (CONT'D)

### BETTER STANDARD MULTI-POINT TOOLS

■ The best selection for use on conventional abrasives in high-production applications

WHEEL DIAMETER	WHEEL GRIT SIZE	TOOL APPROACH ANGLE	TOOL DIAMETER	BETTER		
				PRODUCT #	UPC #	
<b>STOCK MULTI-POINT TOOLS FOR STRAIGHT DRESSING CONVENTIONAL ABRASIVES</b>						
Up to 10"	54 to 100	0°	7/16"	1R6J7	66260195088	
		0°	3/8"	1R6J6	66260195085	
11" to 14"	46	0°	7/16"	2R4K7	66260195095	
	54 to 100	0°	7/16"	2R6K7	66260195096	
		0°	7/16"	2R8K7	66260195097	
15" to 20"	46	0°	7/16"	2A4D7	66260195045	
		15°	7/16"	2A4E7	66260195048	
		15°	7/16"	IB4D7	66260195060	
	54 to 100	0°	7/16"	2A6D7	66260195046	
		15°	7/16"	2A6E7	66260195049	
		0°	7/16"	2A8D7	66260195047	
	120 to 150	15°	7/16"	2A8E7	66260195050	
		46	0°	7/16"	1A4A7	66260195030
			15°	7/16"	1A4C7	66260195038
54 to 100	0°		7/16"	1A6A7	66260195031	
	15°	7/16"	1A6B7	66260195035		
	15°	7/16"	1A6C7	66260195039		
<b>NON-STOCK MULTI-POINT TOOLS FOR STRAIGHT DRESSING CONVENTIONAL ABRASIVES</b>						
Up to 10"	120 to 150	0°	7/16"	1R8J7	66260195089	
		0°	3/8"	1R8J6	66260195086	
21" +	46	15°	7/16"	1A4B7	66260195034	
		0°	7/16"	1A8A7	66260195032	
	120 to 150	15°	7/16"	1A8B7	66260195036	
		15°	7/16"	1A8C7	66260195040	

STANDARD PACKAGE = ONE TOOL

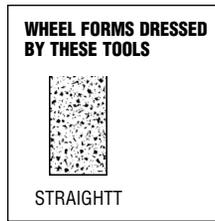

## SPECIALTY MULTI-POINT TOOLS FOR FORM, SHAPE, OR STEP TRUING CONVENTIONAL ABRASIVES

### Tool Shape and Shank Availability

#### 3A

For use on all types of grinders where form, shape or step truing is required.

**Diamond Size Availability: 6, 8**

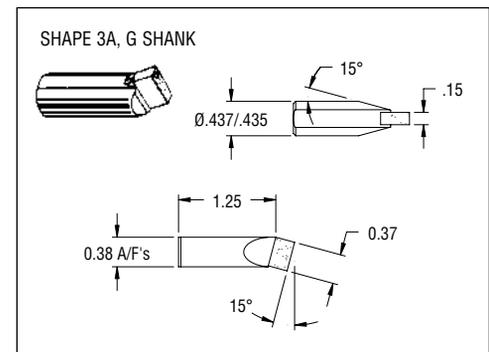
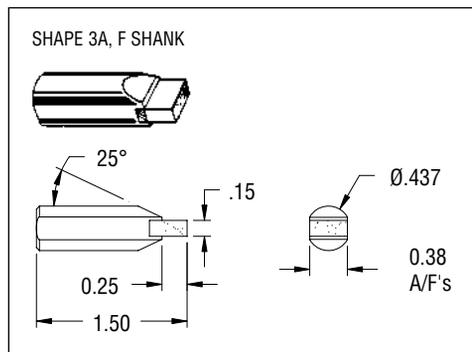
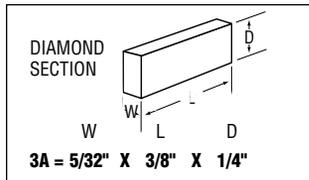

WHEEL DIAMETER	WHEEL GRIT SIZE	TOOL APPROACH ANGLE	TOOL DIAMETER	BETTER	
				PRODUCT #	UPC #
<b>STOCK SPECIALTY MULTI-POINT TOOLS FOR CONVENTIONAL ABRASIVES</b>					
All	54 to 100	0°	7/16"	3A6F7	66260195055
		15°	7/16"	3A6G7	66260195975
	120 to 150	15°	7/16"	3A8G7	66260195058
<b>NON-STOCK SPECIALTY MULTI-POINT TOOLS FOR CONVENTIONAL ABRASIVES</b>					
All	120 to 150	0°	7/16"	3A8F7	66260195056

STANDARD PACKAGE = ONE TOOL

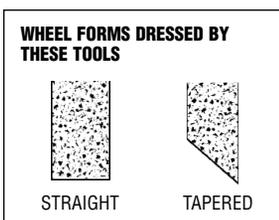

## MULTI-POINT TOOLS FOR ANGULAR DRESSING CONVENTIONAL ABRASIVES

### Tool Shape and Shank Availability

#### 1E

For use on angular grinding machines with wheels up to 24" in diameter.

**Diamond Size Availability: 6**

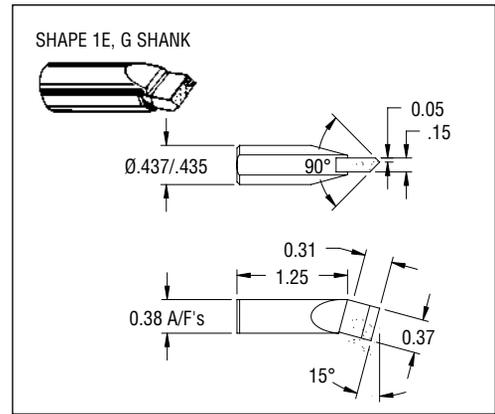
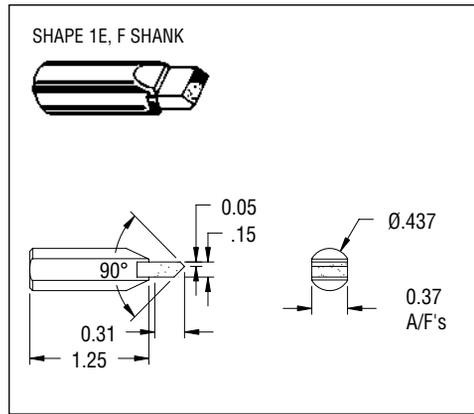
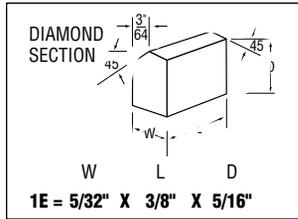

#### 2E

For use on angular grinding machines, with wheels up to 30" in diameter.

**Diamond Size Availability: 6**

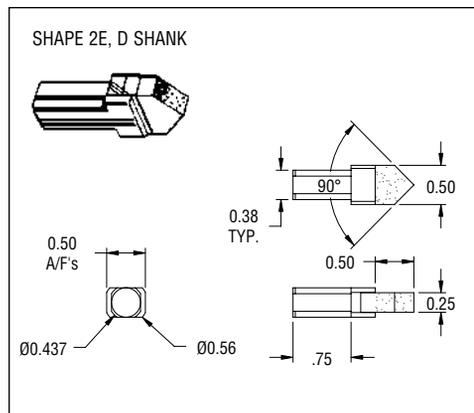
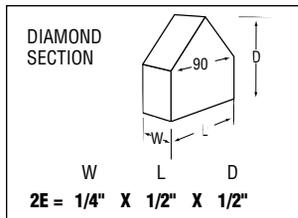

WHEEL DIAMETER	WHEEL GRIT SIZE	TOOL APPROACH ANGLE	TOOL DIAMETER	BETTER	
				PRODUCT #	UPC #
<b>STOCK MULTI-POINT TOOLS FOR ANGULAR DRESSING CONVENTIONAL ABRASIVES</b>					
All	54 to 100	0°	7/16"	1E6F7	66260195080
<b>NON-STOCK MULTI-POINT TOOLS FOR ANGULAR DRESSING CONVENTIONAL ABRASIVES</b>					
All	54 to 100	15°	7/16"	1E6G7	66260195081
		0°	7/16"	2E6D7	66260195083

STANDARD PACKAGE = ONE TOOL

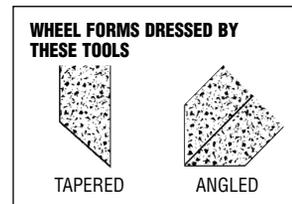

#### DIAMOND SIZE KEY

DIAMOND SIZE	TO DRESS WHEEL WITH GRIT SIZE OF:
4	46
6	54 - 100
8	120 - 150

CONTACT YOUR NORTON REPRESENTATIVE FOR ALL YOUR NON-STOCK, CUSTOM CONFIGURATION QUESTIONS, REQUESTS FOR QUOTES, ETC.

**MULTI-POINT TOOLS FOR TRUING/DRESSING TOOLROOM ABRASIVES**

**Tool Shape and Shank Availability**

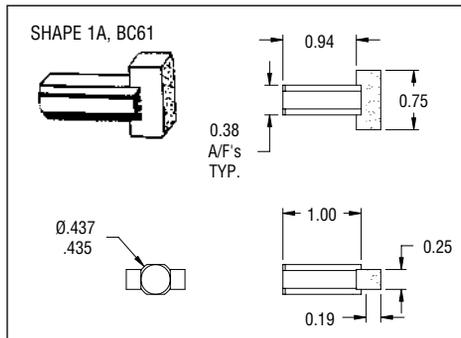
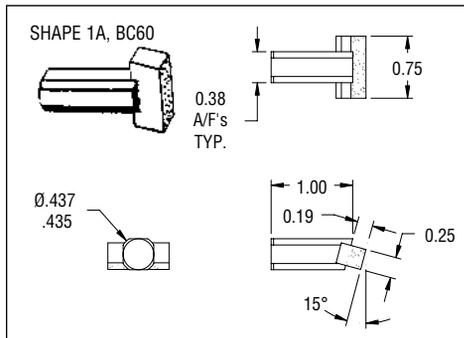
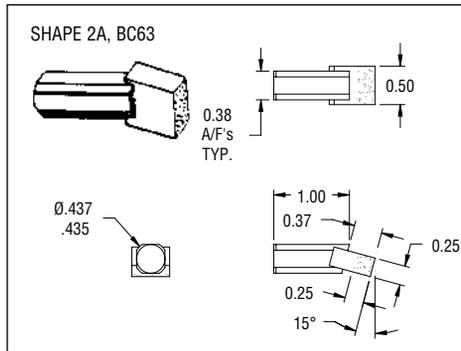
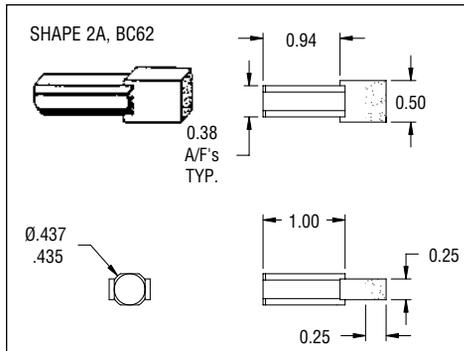
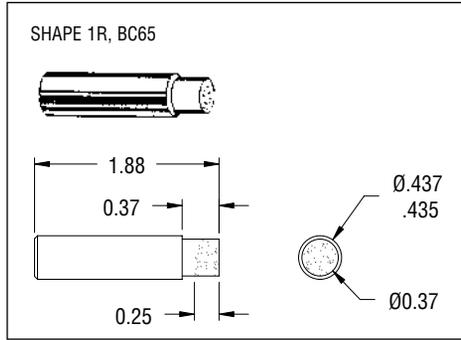
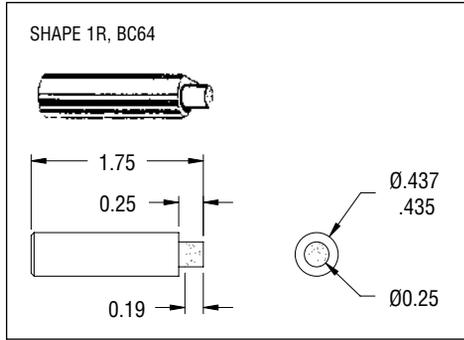

**BC**

All "BC" Multi-Point tools contain a specially selected diamond size for a broad range of dressing applications.

**REFER TO PREVIOUS PAGES FOR EACH TOOL SHAPES APPLICATION DETAILS.**



**GOOD BC MULTI-POINT TOOLS**

These general purpose tools are the ideal selection for conventional toolroom applications

WHEEL DIAMETER	WHEEL GRIT SIZE	TOOL APPROACH ANGLE	TOOL DIAMETER	GOOD	
				PRODUCT #	UPC #
<b>STOCK MULTI-POINT TOOLS FOR TRUING CONVENTIONAL TOOLROOM ABRASIVES</b>					
Up to 10"	54 to 100	0°	7/16"	BC64	66260195014
11" to 14"	54 to 100	0°	7/16"	BC65	66260195015
15" to 20"	54 to 100	0°	7/16"	BC62	66260195012
		15°	7/16"	BC63	66260195013
21" +	54 to 100	0°	7/16"	BC61	66260195011
		15°	7/16"	BC60	66260195010

STANDARD PACKAGE = ONE TOOL

**CONTACT YOUR NORTON REPRESENTATIVE FOR ALL YOUR NON-STOCK, CUSTOM CONFIGURATION QUESTIONS, REQUESTS FOR QUOTES, ETC.**

MACHINE TYPE	WHEEL DIAMETER	DIAMOND SECTION SIZE	SHANK DIAMETER	SHANK LENGTH UNDER HEAD	GOOD	
					PRODUCT #	UPC #
<b>MULTI-POINT TOOLS FOR TRUING cBN TOOLROOM ABRASIVES</b>						
Cylindrical	Up to 12"	1/4 x 3/4 x 5/16 @ 15° Angle	7/16	3/4	1A14C7	66260195041*
			7/16	1-13/16	2R14K7	66260195098*
Surface	6" and less	1/4 dia x 3/8 long	7/16	1-13/16	1R14J7	66260195090*
			7/16	1-13/16	2R14K7	66260195098*
Toolroom	Up to 12"	3/8 dia x 3/8 long	7/16	1-13/16	2R14K7	66260195098*

NOTE: FOR WHEEL DIAMETERS >12", CONTACT YOUR LOCAL NORTON REPRESENTATIVE FOR A RECOMMENDATION.

\* NON-STOCK; CONTACT YOUR NORTON REPRESENTATIVE FOR CURRENT LEAD-TIME.



## HIGH PERFORMANCE GRIT TOOLS

Norton High Performance Grit Tools are used in the same manner as multi-point tools, but are designed to produce a superior finish. They are used on 120 - 150 grit wheels. The traverse rates are equal to or faster than ordinary tools. Mounted on standard shanks, standard High Performance Grit Tools have a 3/8" wide by .100" thick diamond impregnated blade with a greater number of sharp points than in ordinary multi-point tools. Since High Performance Grit Tools contain a higher concentration of diamond than found in standard multi-point tools, they are well suited for ceramic abrasive applications.

### Typical Machines and Applications

- Large angle-head cylindrical machines, grinding shoulders, faces, and bearing diameters
- Cylindrical machines used for grinding main bearings and lobes on camshafts
- Centerless machines that plunge grind on multi-diameter shafts
- Centerless machines used for step grinding

### Standard High Performance Grit Tool Shapes

**HP4439**  
HP4439 is designed for cylindrical machines, grinding thrust walls, bearing diameters, and multi-diameter shafts with radii. Shank length is 1-1/4" with 15° angle.

**HP4511**  
HP4511 is designed for angular machines that plunge grind on multi-diameter shafts, or plunge grind on dual-wheel form grinding jobs. Shank length is 1-1/4". Tool should be mounted perpendicular to the wheel face.

**HP4595**  
HP4595 is designed for cylindrical machines used for grinding main bearing and lobes on camshafts. Shank length is 1-1/4". Tool should be mounted perpendicular to the wheel face.

**HP4596**  
HP4596 is designed for centerless machines used for step grinding, and for machines which perform dual-wheel grinding on transmission shafts. Shank length is 1-1/4" with 15° drag angle.

WHEEL DIAMETER	WHEEL GRIT SIZE	SHANK DIAMETER	TOOL LENGTH	BEST	
				PRODUCT #	UPC #
<b>STOCK HIGH PERFORMANCE GRIT TOOLS</b>					
Up to 20"	120 to 150	7/16"	1-9/16"	HP4439	66260195270
Up to 20"	120 to 150	7/16"	1-9/16"	HP4511	66260195271
Up to 20"	120 to 150	7/16"	1-9/16"	HP4595	66260195272
Up to 20"	120 to 150	7/16"	1-9/16"	HP4596	66260195273

STANDARD PACKAGE = ONE TOOL

**WHEEL FORMS DRESSED BY THESE TOOLS**

STRAIGHT      TAPERED

## BLADE TOOLS

With the choice of natural and synthetic diamond in three performance/price tiers, Norton blade tools can meet all your angle, step, and radius dressing requirements for cylindrical, surface, and centerless grinding.

### WHEEL FORMS DRESSED BY THESE TOOLS

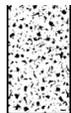

STRAIGHT



TAPERED

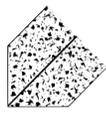

ANGLED



MULTI-ANGLED



### BEST

### SYNTHETIC BLADE TOOLS

#### FEATURES

- USB
- Norton Quantum (NQ)
- Synthetic diamond with a controlled diamond shape provides a constant cross section of diamond to the wheel throughout the life of the tool

#### BENEFITS

- For dressing aluminum oxide
- For dressing ceramics and silicon carbide
- Provides consistent wheel conditioning from the first dress to last
- Ideal for close tolerance wheel dressing on manual and CNC grinders, long production runs, and critical form and finish applications (e.g. automotive cam, crank, and valve grinding)
- Economical, long-lasting alternative to chisel-type tools for centerless form grinding

### BETTER

### MULTI-CUT BLADE TOOLS

#### FEATURES

- Manufactured with top quality elongated-shaped natural diamond

#### BENEFITS

- The best choice when natural diamond is preferred on surface, cylindrical, and centerless grinders
- Durable performing tools in a medium price range

### GOOD

### LONG LIFE BLADE TOOLS

#### FEATURES

- Manufactured with processed elongated shaped natural diamond

#### BENEFITS

- Developed as the first generation of the blade tool line for surface, cylindrical, and centerless grinders
- The choice when initial price is the primary purchasing consideration

## TECHtip

### MOUNTING BLADE TOOLS

- Blade Tools should be mounted with the centerline of the wheel. The tool is mounted so that all the diamonds are perpendicular to the wheel face. This illustrates the proper dressing position and angle for common centerless and cylindrical applications.
- Mounted with a 15° post holder, the shank of the tool is at a 15° angle with the wheel centerline.
- On straight applications, the tool is mounted perpendicular to the wheel face with no drag angle.

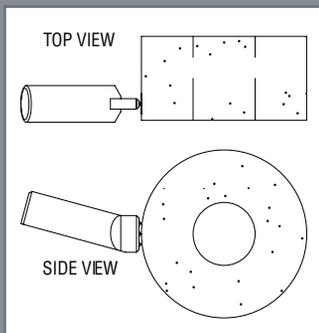

### HOW TO USE BLADE TOOLS

- Mount the tool on a flat, so that the tool is square in the holder. Tools that are offset will cause the form to cut wide.
- Mount the tool so that all the diamonds are vertical to the wheel face.
- When using a layer tool, the tool may become dull between layers. Four or five heavy infeed passes at .002" to .004" will correct this situation.
- Blade Tools are not resettable and should not be rotated.
- Use a 3/8" stream of coolant at the point of contact ensuring that both sides of the diamond section are protected.
- Use appropriate truing lead.
- Whenever mounting a new grinding wheel, make certain that the truing system is fully retracted.



It is the user's responsibility to refer to and comply with ANSI B7.1

# SPECcheck

## USB BLADE TOOL MARKING SYSTEM

SYNTHETIC DIAMOND TYPE	NUMBER OF DIAMONDS	TOOL APPROACH ANGLE	DIAMOND SETTING POSITION	SHANK DIAMETER	MINIMUM RADIUS TO BE DRESSED
USC = CVD	2	0°	A = Angled	7 = 7/16"	.008"
	3	10°		6 = 3/8"	.0"
	5	15°		11 = 11mm	.05"

EXAMPLE: USC 3 10 A 7

### USB Blade Tools

- Use a 3/8" diameter stream of coolant directed at point of contact with the wheel.
- Normal infeed should not exceed .001" for aluminum oxide wheels. Decrease by 25% when dressing ceramic SG and Norton Quantum NQ wheels and by 50% when dressing ceramic Targa TG wheels.
- To calculate traverse rate (the speed the tool moves across the wheel):  
Wheel RPM x .015" = Traverse Rate inches/minute  
A slower traverse rate equals lower surface finish readings.
- Mount tools with all diamonds contacting the wheel. Position row of diamonds vertically.

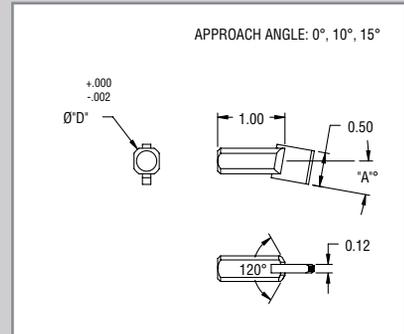

## MULTI-CUT BLADE TOOL MARKING SYSTEM

TOOL TYPE	NUMBER OF DIAMONDS	APPROXIMATE DIAMETER OF DIAMONDS	MINIMUM AND CONCAVE RADIUS TO BE DRESSED
MC = 15° Drag Angle	2 = 1 layer of 2 diamonds	55 = .055"	.028"
MCS = 0° Drag Angle	3 = 1 layer of 3 diamonds	75 = .075"	.038"
		90 = .090"	.045"

EXAMPLE: MC 3 75

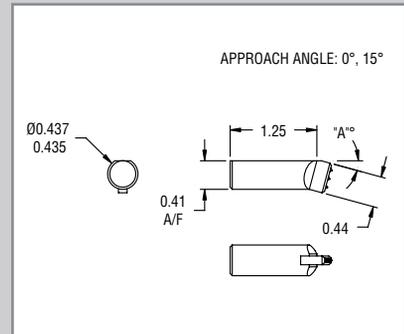

## LONG LIFE BLADE TOOL MARKING SYSTEM

TOOL TYPE	STYLE	NUMBER OF LAYERS	APPROXIMATE DIAMETER OF DIAMONDS	MINIMUM RADIUS TO BE DRESSED
LL =	20 = 5 stones @ 15° Drag Angle	1 = 1 layer	A = .030"	.015"
Long Life	27 = 5 stones @ 0° Drag Angle	Non-stock:	B = .040"	.020"
		2 and 3 layers are available	C = .050"	.025"
		on request	D = .060"	.030"

EXAMPLE: LL 20 1 A

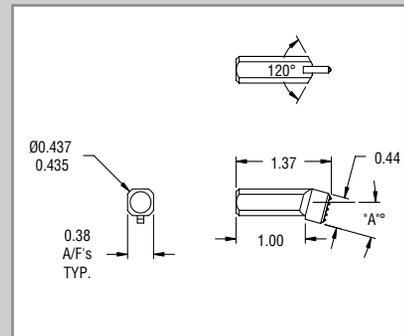

## BLADE TOOLS

WHEEL DIAMETER (WIDTH ≤ 9")	TOOL APPROACH ANGLE	SHANK DIAMETER	BEST NQTOOLS		BEST USB TOOLS		BETTER MULTI-CUT TOOLS		GOOD LONG LIFE TOOLS	
			PRODUCT #	UPC #	PRODUCT #	UPC #	PRODUCT #	UPC #	PRODUCT #	UPC #
<b>STOCK BLADE TOOLS</b>										
12" to 17"	0	7/16	NQ20A7	07958747944						
	15°	7/16"	NQ215A7	07958747945			MC355	66260195266		
18" to 29"	0	7/16	NQ30A7	07958747946						
	15°	7/16"	NQ315A7	07958747947			MC375	66260195267		
30" to 36"	0	7/16	NQ50A7	07958747948						
	15	7/16	NQ515A7	07958747950						
<b>NON-STOCK BLADE TOOLS</b>										
Up to 11"	0°	7/16"					MCS255	66260148412	LL271A	66260196447
	15°	7/16"					MC255	66260195265	LL201A	66260196446
12" to 17"	0°	7/16"			USC20A7	66260103532	MCS355	66260195268	LL271B	66260196449
	10°	7/16"			USC210A7	66260103534				
	15°	7/16"			USC215A7	66260103535			LL201B	66260196448
18" to 29"	0°	7/16"			USC30A7	66260103305	MCS375	66260148417	LL271C	66260196451
	10°	7/16"			USC310A7	66260103545				
	15°	7/16"			USC315A7	66260103303			LL201C	66260196450
30" to 36"	0°	7/16"			USC50A7	66260103306	MCS390	66260148418	LL271D	66260196453
	10°	7/16"			USC510A7	66260103555				
	15°	7/16"			USC515A7	66260103307	MC390	66260196266	LL201D	66260196452

**THESE TOOLS ARE NOT RESETTABLE OR RELAPPABLE.**  
**OTHER SHANK DIAMETERS AND CONFIGURATIONS ARE AVAILABLE.**  
**BLADE TOOLS FOR DRESSING WHEEL WIDTHS > 9" ARE ALSO AVAILABLE.**  
**STANDARD PACKAGE = ONE TOOL**

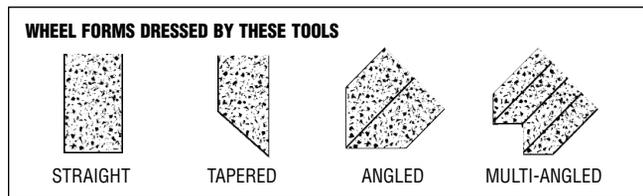

**CONTACT YOUR NORTON REPRESENTATIVE FOR ALL YOUR NON-STOCK, CUSTOM CONFIGURATION QUESTIONS, REQUESTS FOR QUOTES, ETC.**

## FORM TOOLS

Norton Form Tools have diamond lapped to specific angles and radii required for a particular application, machine, contour dressing system or CNC operation. Due to the high degree of accuracy necessary, the diamond is of special shape and quality.

### WHEEL FORMS DRESSED BY THESE TOOLS



CONVEX



CONCAVE

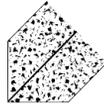

ANGLED



MULTI-ANGLED



## TECHtip

### HOW TO USE FORM DRESSING TOOLS

- Form Tools should be used in compliance with the guidelines established for the machine or dress.
- Proper centerline and light infeeds are essential to minimize side pressure. Excessive pressure will cause the diamond to fracture.
- Chisel Point Tools should be rotated 180° when dulling or contour problems occur.
- Cone point tools should be rotated approximately 1/4 turn daily.

### BEST

### CONE POINT TOOLS

- The Norton vacuum braze technology used in the manufacturing of cone points surpasses all traditional diamond retention methods.
- Benefits of this technology include absolute diamond retention, diamond pullout prevention during the dressing cycle, and longer tool life through multiple relaps.
- Because the diamond is accurately coned to the specific included angle and radius, these tools are ideal when the most intricate, precise forms and radii are required.
- Can be relapped.

### U-DEX-IT CONE POINT TOOL

Used for precision dressing of intricate forms and radii. Specially designed with 5/8" indexable head for easy turning during use. These tools can be relapped.

					BEST	
INCLUDED ANGLE ON DIAMOND	RADIUS ON DIAMOND	TOOL CARAT WEIGHT	SHANK DIAM.	TOOL LENGTH	NPRODUCT #	RELAPPABLE UPC #
75°	.020"	.50	7/16"	1.678"	CPUD720-7	66260158981

STOCK U-DEX-IT CONE POINT TOOL

STANDARD PACKAGE = ONE TOOL

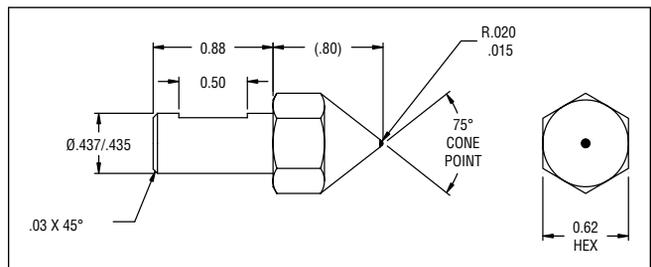

### WHEEL FORMS DRESSED BY THESE TOOLS



CONVEX



CONCAVE

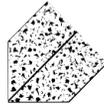

ANGLED



MULTI-ANGLED

## SPE *check*

### CONE POINT TOOL MARKING SYSTEM

TOOL TYPE	INCLUDED ANGLE ON DIAMOND	RADIUS ON DIAMOND	CARAT WEIGHT	SHANK DIAMETER
CP	6 = 60°	05 = .005"	L = .10 - .15	6 = 3/8"
	7 = 75°	10 = .010"	M = .20 - .25	7 = 7/16"
	9 = 90°	15 = .015"	H = .33	
		20 = .020"	X = .50	
		25 = .025"		
		30 = .030"		

EXAMPLE: CP 6 10 M-6



## STANDARD CONE POINT TOOLS

These tools are used for precision dressing when the most intricate forms and radii are required. Can be relapped.

INCLUDED ANGLE ON DIAMOND	RADIUS ON DIAMOND	TOOL CARAT WEIGHT	SHANK DIAMETER	TOOL LENGTH	BEST	
					PRODUCT #	RELAPPABLE UPC #
<b>STOCK STANDARD CONE POINT TOOLS</b>						
60°	.010"	.20 - .25	3/8"	2"	CP610M-6	66260195240

STANDARD PACKAGE = ONE TOOL

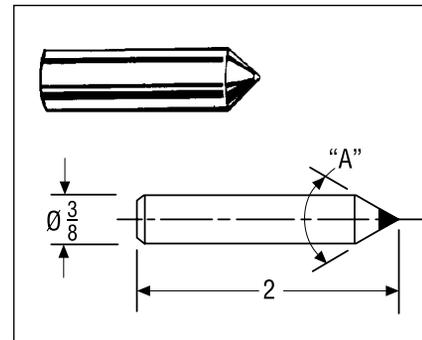

## NON-STOCK STANDARD CONE POINT TOOLS

WHEEL DIAMETER	INCLUDED ANGLE ON DIAMOND	RADIUS ON DIAMOND	TOOL CARAT WEIGHT	SHANK DIAMETER	TOOL LENGTH	BEST	
						PRODUCT #	RELAPPABLE UPC #
<b>NON-STOCK STANDARD CONE POINT TOOLS</b>							
Up to 10"	60°	.005"	.10 - .15	3/8"	2"	CP65L-6	66260196098
11" - 14"			.20 - .25				
15" - 20"			0.33				
21" - 24"			0.50				
Up to 10"	60°	.010"	.10 - .15	3/8"	2"	CP610L-6	66260196099
11" - 14"			.20 - .25				
15" - 20"			0.33				
21" - 24"			0.50				
Up to 10"	60°	.015"	.10 - .15	3/8"	2"	CP615L-6	66260195176
11" - 14"			.20 - .25				
15" - 20"			0.33				
21" - 24"			0.50				
Up to 10"	60°	.020"	.10 - .15	3/8"	2"	CP620L-6	66260196102
11" - 14"			.20 - .25				
15" - 20"			0.33				
21" - 24"			0.50				
Up to 10"	60°	.025"	.10 - .15	3/8"	2"	CP625L-6	66260151328
11" - 14"			.20 - .25				
15" - 20"			0.33				
21" - 24"			0.50				
Up to 10"	60°	.030"	.10 - .15	3/8"	2"	CP630L-6	66260151357
11" - 14"			.20 - .25				
15" - 20"			0.33				
21" - 24"			0.50				

\*STOCK

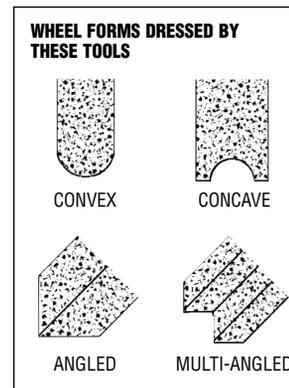

## TECHtip

### HOW TO ORDER NON-STOCK CONE POINT TOOLS

- Order by tool type, included angle, radius, and carat weight required.
- Unless otherwise specified, tools will be furnished in 3/8" x 2" shank as illustrated. Prices for radii not listed and/or other included angles will be quoted upon request.
- 7/16" diameter shank is available at no additional cost.

## SPECcheck

### CONE POINT TOOL MARKING SYSTEM

TOOL TYPE	INCLUDED ANGLE ON DIAMOND	RADIUS ON DIAMOND	CARAT WEIGHT	SHANK DIAMETER
CP	6 = 60°	05 = .005"	L = .10 - .15	6 = 3/8"
	7 = 75°	10 = .010"	M = .20 - .25	7 = 7/16"
	9 = 90°	15 = .015"	H = .33	
		20 = .020"	X = .50	
		25 = .025"		
		30 = .030"		

EXAMPLE: CP 6 10 M-6

CONTACT YOUR NORTON REPRESENTATIVE FOR ALL YOUR NON-STOCK, CUSTOM CONFIGURATION QUESTIONS, REQUESTS FOR QUOTES, ETC.

NON-STOCK STANDARD CONE POINT TOOLS (CONTINUED)

WHEEL DIAMETER	INCLUDED ANGLE ON DIAMOND	RADIUS ON DIAMOND	TOOL CARAT WEIGHT	SHANK DIAMETER	TOOL LENGTH	BEST	
						PRODUCT #	RELAPPABLE UPC #
<b>NON-STOCK STANDARD CONE POINT TOOLS (CONTINUED)</b>							
Up to 10"	75°	.005"	.10 - .15	3/8"	2"	CP75L-6	66260196115
11" - 14"			.20 - .25			CP75M-6	66260196117
15" - 20"			0.33			CP75H-6	66260196120
21" - 24"			0.50			CP75X-6	66260196126
Up to 10"	75°	.010"	.10 - .15	3/8"	2"	CP710L-6	66260196116
11" - 14"			.20 - .25			CP710M-6	66260195241
15" - 20"			0.33			CP710H-6	66260196121
21" - 24"			0.50			CP710X-6	66260196127
Up to 10"	75°	.015"	.10 - .15	3/8"	2"	CP715L-6	66260196118
11" - 14"			.20 - .25			CP715M-6	66260196118
15" - 20"			0.33			CP715H-6	66260196122
21" - 24"			0.50			CP715X-6	66260196128
Up to 10"	75°	.020"	.10 - .15	3/8"	2"	CP720L-6	66260196119
11" - 14"			.20 - .25			CP720M-6	66260196119
15" - 20"			0.33			CP720H-6	66260196123
21" - 24"			0.50			CP720X-6	66260196129
Up to 10"	75°	.025"	.10 - .15	3/8"	2"	CP725L-6	66260151448
11" - 14"			.20 - .25			CP725M-6	66260151448
15" - 20"			0.33			CP725H-6	66260196124
21" - 24"			0.50			CP725X-6	66260196130
Up to 10"	75°	.030"	.10 - .15	3/8"	2"	CP730L-6	66260196125
11" - 14"			.20 - .25			CP730M-6	66260196131
15" - 20"			0.33			CP730H-6	66260196125
21" - 24"			0.50			CP730X-6	66260196131
Up to 10"	90°	.005"	.10 - .15	3/8"	2"	CP95L-6	66260196132
11" - 14"			.20 - .25			CP95M-6	66260196134
15" - 20"			0.33			CP95H-6	66260196137
21" - 24"			0.50			CP95X-6	66260196143
Up to 10"	90°	.010"	.10 - .15	3/8"	2"	CP910L-6	66260196133
11" - 14"			.20 - .25			CP910M-6	66260195242
15" - 20"			0.33			CP910H-6	66260196138
21" - 24"			0.50			CP910X-6	66260196144
Up to 10"	90°	.015"	.10 - .15	3/8"	2"	CP915L-6	66260158012
11" - 14"			.20 - .25			CP915M-6	66260196135
15" - 20"			0.33			CP915H-6	66260196139
21" - 24"			0.50			CP915X-6	66260196145
Up to 10"	90°	.020"	.10 - .15	3/8"	2"	CP920L-6	66260196136
11" - 14"			.20 - .25			CP920M-6	66260196136
15" - 20"			0.33			CP920H-6	66260196140
21" - 24"			0.50			CP920X-6	66260196146
Up to 10"	90°	.025"	.10 - .15	3/8"	2"	CP925L-6	66260151645
11" - 14"			.20 - .25			CP925M-6	66260151645
15" - 20"			0.33			CP925H-6	66260196141
21" - 24"			0.50			CP925X-6	66260196147
Up to 10"	90°	.030"	.10 - .15	3/8"	2"	CP930L-6	66260151673
11" - 14"			.20 - .25			CP930M-6	66260151673
15" - 20"			0.33			CP930H-6	66260196142
21" - 24"			0.50			CP930X-6	66260196148

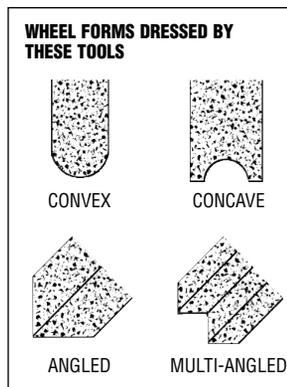

CONTACT YOUR NORTON REPRESENTATIVE FOR ALL YOUR NON-STOCK, CUSTOM CONFIGURATION QUESTIONS, REQUESTS FOR QUOTES, ETC.

## CHISEL POINT TOOL FOR TOYODA GRINDERS

High precision chisel point tool designed for forming intricate shapes and radii. Specifically engineered to fit Toyoda machine series GL32 and GL4, it can also be used on various straight and angle-head grinders – for dressing conventional and ceramic abrasive wheels, sizes 12" to 24". This tool can be reset/re-lapped.

INCLUDED ANGLE ON DIAMOND	RADIUS ON DIAMOND	TOOL CARAT WEIGHT	SHANK DIAMETER	TOOL LENGTH	BEST	
					PRODUCT #	RELAPPABLE UPC #
<b>STOCK CHISEL POINT TOOL</b>						
55°	.020"	.75	7/16"	1.10"	CHT520-7	66260103741

**STANDARD PACKAGE = ONE TOOL**

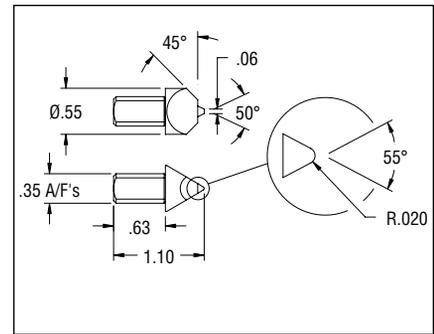

## TECHtip

Chisel Point Tools should be rotated 180° when dulling or contour problems occur.

## NON-STOCK STANDARD CHISEL POINT TOOLS

This line offers precision tools designed to form intricate radii, steps or contours on toolroom-type applications. Can be relapped or reset/re-lapped.

WHEEL DIAMETER	INCLUDED ANGLE ON DIAMOND	RADIUS ON DIAMOND	TOOL CARAT WEIGHT	SHANK DIAMETER	TOOL LENGTH	BEST	
						PRODUCT #	RELAPPABLE UPC #
<b>NON-STOCK STANDARD CHISEL POINT TOOLS</b>							
Up to 10"	60°	.005"	.10 - .15	3/8"	2"	CH65L-6	66260196150
11" - 14"			.20 - .25			CH65M-6	66260196154
15" - 20"			0.33			CH65H-6	66260196160
21" - 24"			0.50			CH65X-6	66260196166
Up to 10"	60°	.010"	.10 - .15	3/8"	2"	CH610L-6	66260196151
11" - 14"			.20 - .25			CH610M-6	66260196155
15" - 20"			0.33			CH610H-6	66260195245
21" - 24"			0.50			CH610X-6	66260196167
Up to 10"	60°	.015"	.10 - .15	3/8"	2"	CH615L-6	66260196152
11" - 14"			.20 - .25			CH615M-6	66260196156
15" - 20"			0.33			CH615H-6	66260196161
21" - 24"			0.50			CH615X-6	66260196168
Up to 10"	60°	.020"	.10 - .15	3/8"	2"	CH620L-6	66260196157
11" - 14"			.20 - .25			CH620M-6	66260196162
15" - 20"			0.33			CH620H-6	66260196162
21" - 24"			0.50			CH620X-6	66260196169
Up to 10"	60°	.025"	.10 - .15	3/8"	2"	CH625L-6	66260196158
11" - 14"			.20 - .25			CH625M-6	66260196158
15" - 20"			0.33			CH625H-6	66260196163
21" - 24"			0.50			CH625X-6	66260196170
Up to 10"	60°	.030"	.10 - .15	3/8"	2"	CH630L-6	66260158176
11" - 14"			.20 - .25			CH630M-6	66260196164
15" - 20"			0.33			CH630H-6	66260196164
21" - 24"			0.50			CH630X-6	66260196492
Up to 10"	75°	.005"	.10 - .15	3/8"	2"	CH75L-6	66260196172
11" - 14"			.20 - .25			CH75M-6	66260196176
15" - 20"			0.33			CH75H-6	66260196182
21" - 24"			0.50			CH75X-6	66260196189
Up to 10"	75°	.010"	.10 - .15	3/8"	2"	CH710L-6	66260196173
11" - 14"			.20 - .25			CH710M-6	66260196177
15" - 20"			0.33			CH710H-6	66260196183
21" - 24"			0.50			CH710X-6	66260196190

CONTINUED

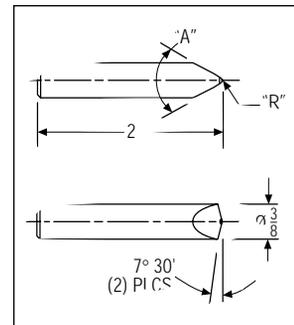

### WHEEL FORMS DRESSED BY THESE TOOLS



CONVEX



CONCAVE

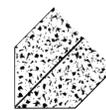

ANGLED



MULTI-ANGLED

**CONTACT YOUR NORTON REPRESENTATIVE FOR ALL YOUR NON-STOCK, CUSTOM CONFIGURATION QUESTIONS, REQUESTS FOR QUOTES, ETC.**

NON-STOCK STANDARD CHISEL POINT TOOLS (CONTINUED)

WHEEL DIAMETER	INCLUDED ANGLE ON DIAMOND	RADIUS ON DIAMOND	TOOL CARAT WEIGHT	SHANK DIAMETER	TOOL LENGTH	BEST	
						PRODUCT #	RELAPPABLE UPC #
<b>NON-STOCK STANDARD CHISEL POINT TOOLS</b>							
Up to 10"	75°	.015"	.10 - .15	3/8"	2"	CH715L-6	66260196174
11" - 14"			.20 - .25			CH715M-6	66260196178
15" - 20"			0.33			CH715H-6	66260196184
21" - 24"			0.50			CH715X-6	66260196191
Up to 10"	75°	.020"	.10 - .15	3/8"	2"	CH720L-6	
11" - 14"			.20 - .25			CH720M-6	66260196179
15" - 20"			0.33			CH720H-6	66260196185
21" - 24"			0.50			CH720X-6	66260196192
Up to 10"	75°	.025"	.10 - .15	3/8"	2"	CH725L-6	
11" - 14"			.20 - .25			CH725M-6	66260196180
15" - 20"			0.33			CH725H-6	66260196186
21" - 24"			0.50			CH725X-6	66260196193
Up to 10"	75°	.030"	.10 - .15	3/8"	2"	CH730L-6	
11" - 14"			.20 - .25			CH730M-6	
15" - 20"			0.33			CH730H-6	66260196187
21" - 24"			0.50			CH730X-6	66260196194
Up to 10"	90°	.005"	.10 - .15	3/8"	2"	CH95L-6	66260196196
11" - 14"			.20 - .25			CH95M-6	66260196202
15" - 20"			0.33			CH95H-6	66260196208
21" - 24"			0.50			CH95X-6	66260196215
Up to 10"	90°	.010"	.10 - .15	3/8"	2"	CH910L-6	66260196197
11" - 14"			.20 - .25			CH910M-6	66260196203
15" - 20"			0.33			CH910H-6	66260196209
21" - 24"			0.50			CH910X-6	66260196493
Up to 10"	90°	.015"	.10 - .15	3/8"	2"	CH915L-6	66260196198
11" - 14"			.20 - .25			CH915M-6	66260196204
15" - 20"			0.33			CH915H-6	66260196210
21" - 24"			0.50			CH915X-6	66260196216
Up to 10"	90°	.020"	.10 - .15	3/8"	2"	CH920L-6	
11" - 14"			.20 - .25			CH920M-6	66260196205
15" - 20"			0.33			CH920H-6	66260196211
21" - 24"			0.50			CH920X-6	66260196217
Up to 10"	90°	.025"	.10 - .15	3/8"	2"	CH925L-6	
11" - 14"			.20 - .25			CH925M-6	66260196206
15" - 20"			0.33			CH925H-6	66260196212
21" - 24"			0.50			CH925X-6	66260196218
Up to 10"	90°	.030"	.10 - .15	3/8"	2"	CH930L-6	
11" - 14"			.20 - .25			CH930M-6	66260163376
15" - 20"			0.33			CH930H-6	66260196213
21" - 24"			0.50			CH930X-6	66260196219

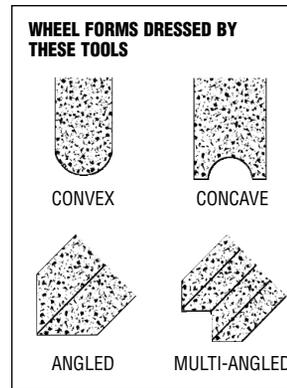

# TECHtip

## HOW TO ORDER NON-STOCK CHISEL POINT TOOLS

- Order by tool type, included angle, radius, and carat weight required.
- Tools will be furnished in 3/8" x 2" shank as illustrated. Prices for radii not listed and/or other included angles will be quoted upon request.
- 7/16" diameter shank is available at no additional cost.

# SPECcheck

## CONE POINT TOOL MARKING SYSTEM

TOOL TYPE	INCLUDED ANGLE ON DIAMOND	RADIUS ON DIAMOND	CARAT WEIGHT	SHANK DIAMETER
<b>CH =</b> <b>Natural Diamond</b>	6 = 60°	05 = .005"	L = .10 - .15	6 = 3/8"
	7 = 75°	10 = .010"	M = .20 - .25	7 = 7/16"
	9 = 90°	15 = .015"	H = .33	
		20 = .020"	X = .50	
		25 = .025"		
		30 = .030"		

EXAMPLE: CH 9 5 M-6

## STANDARD FORM TOOLS FOR JONES & LAMSON MACHINES

### BEST FORM TOOLS – JONES & LAMSON MACHINES

- Used primarily on Jones & Lamson machines; 9/32" x 1-1/4" shank
- The applications dictates the tool to choose
- Can be relapped or reset/relapped

INCLUDED ANGLE ON DIAMOND	RADIUS ON DIAMOND	BEST	
		PRODUCT #	RELAPPABLE UPC #
<b>NON-STOCK JONES &amp; LAMSON FORM TOOLS</b>			
50°	0.005"	JL105	66260158847
	0.010"	JL110	66260159824
	0.015"	JL115	66260141699
	0.020"	JL120	66260141700
40°	0.005"	JL205	66260142524
	0.010"	JL210	66260155893
	0.015"	JL215	
30°	0.020"	JL220	
	0.005"	JL305	66260141701
	0.010"	JL310	66260142528
	0.015"	JL315	66260142529
	0.020"	JL320	66260158989

STANDARD PACKAGE = 1 TOOL

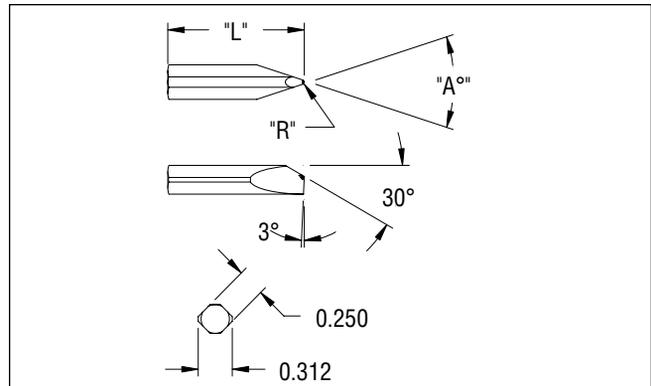

## SPECcheck

### JONES & LAMSON TOOL MARKING SYSTEM

TOOL TYPE	INCLUDED ANGLE ON DIAMOND	RADIUS ON DIAMOND
JL = Natural Diamond	1 = 50°	05 = .005"
	2 = 40°	10 = .010"
	3 = 30°	15 = .015"
		20 = .020"

EXAMPLE: JL 1 10

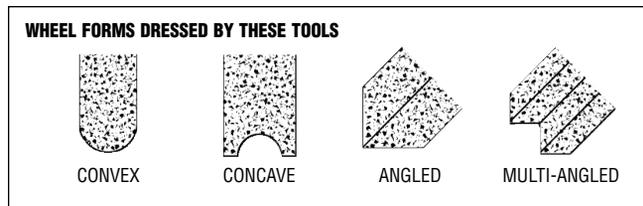

## STANDARD FORM TOOLS FOR MOORE PANTOGRAPH MACHINES

### BEST FORM TOOLS – MOORE PANTOGRAPH MACHINES

- Used primarily on Moore Pantograph machines; 1/4" x 1-9/16" shank
- The applications dictates the tool to choose
- Can be relapped or reset/relapped

INCLUDED ANGLE ON DIAMOND	RADIUS ON DIAMOND	BEST	
		PRODUCT #	RELAPPABLE UPC #
<b>NON-STOCK MOORE PANTOGRAPH FORM TOOLS</b>			
30°	0.005"	M053056	66260195280
	0.010"	M0103056	66260195281
	0.015"	M0153056	66260195282
	0.020"	M0203056	66260196282
	0.025"	M0253056	66260196283
60°	0.005"	M056056	66260196276
	0.010"	M0106056	66260196277
	0.015"	M0156056	66260196278
	0.020"	M0206056	66260196286
	0.025"	M0256056	66260196287

40° AND 90° INCLUDED ANGLES ARE ALSO AVAILABLE.

STANDARD PACKAGE = 1 TOOL

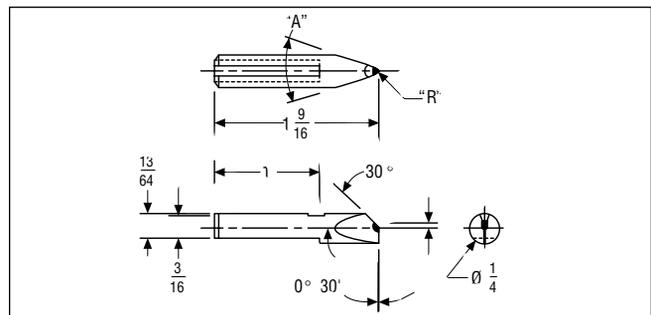

## SPECcheck

### MOORE PANTOGRAPH TOOL MARKING SYSTEM

TOOL TYPE	RADIUS ON DIAMONDS	INCLUDED ANGLE ON DIAMOND	SHANK DIAMETER
MO = Natural Diamond	05 = .005"	30 = 30°	56 = 1-9/16"
	10 = .010"	40 = 40°	
	15 = .015"	60 = 60°	
	20 = .020"	90 = 90°	
	25 = .025"		

EXAMPLE: MO 5 30 56

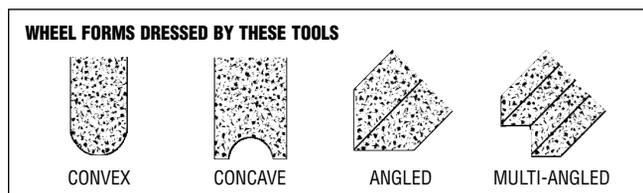

## STANDARD FORM TOOLS FOR HOGLUND MACHINES

### BEST FORM TOOLS – HOGLUND MACHINES

- Used primarily on Hoglund machines
- The applications dictates the tool to choose

INCLUDED ANGLE ON DIAMOND	RADIUS ON DIAMOND	BEST	
		PRODUCT #	UPC #
<b>NON-STOCK HOGLUND FORM TOOLS</b>			
42°	0.005"	HG54262	66260142466
	0.010"	HG104262	66260142489
	0.015"	HG154262	66260142346
	0.020"	HG204262	66260142403
	0.025"	HG254262	66260142459
60°	0.005"	HG56062	66260142470
	0.010"	HG106062	66260142294
	0.015"	HG156062	66260142351
	0.020"	HG206062	66260142407
	0.025"	HG256062	66260142463

48° AND 72° INCLUDED ANGLES ARE ALSO AVAILABLE, AS ARE 1-1/2 AND 1-3/4" TOOL LENGTHS. STANDARD PACKAGE = 1 TOOL

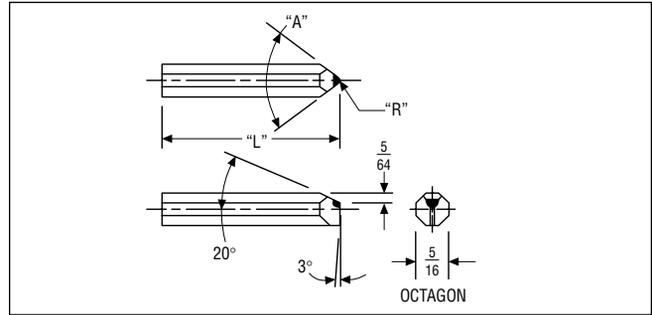

### SPECcheck HOGLUND TOOL MARKING SYSTEM

TOOL TYPE	RADIUS ON DIAMOND	INCLUDED ANGLE ON DIAMOND	TOOL LENGTH	
<b>HG =</b>	05 = .005"	42 = 42°	50 = 1-1/2"	
	Natural	48 = 48°	62 = 1-5/8"	
	<b>Diamond</b>	15 = .015"	60 = 60°	75 = 1-3/4"
		20 = .020"	72 = 72°	
		25 = .025"		

EXAMPLE: HG 10 42 62

#### WHEEL FORMS DRESSED BY THESE TOOLS

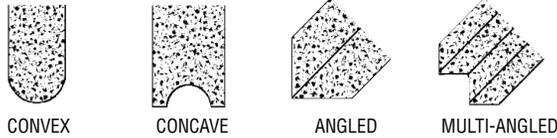

## STANDARD FORM TOOLS FOR DIA-FORM MACHINES

### BEST FORM TOOLS – DIA-FORM MACHINES

- Used primarily on Dia-Form machines
- The applications dictates the tool to choose
- Can be relapped or reset/relapped

INCLUDED ANGLE ON DIAMOND	RADIUS ON DIAMOND	BEST	
		PRODUCT #	RELAPPABLE UPC #
<b>NON-STOCK DIA-FORM TOOLS</b>			
40°	0.005"	DI052138	66260196310
	0.010"	DI102138	66260196311
	0.015"	DI152138	66260196312
	0.020"	DI202138	66260196314
	0.025"	DI252138	66260196316
60°	0.005"	DI051138	66260195289
	0.010"	DI101138	66260195290
	0.015"	DI151138	66260195292
	0.020"	DI201138	66260196313
	0.025"	DI251138	66260196315

1-3/4" AND 2-1/4" TOOL LENGTHS ARE ALSO AVAILABLE. STANDARD PACKAGE = 1 TOOL

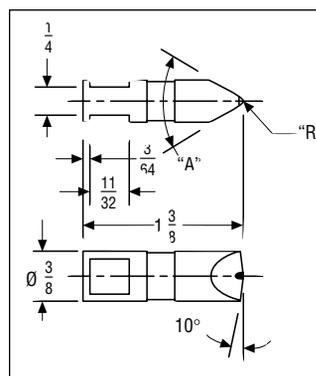

#### WHEEL FORMS DRESSED BY THESE TOOLS

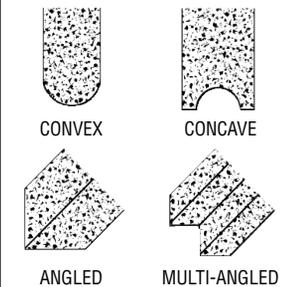

### SPECcheck DIA-FORM TOOL MARKING SYSTEM

TOOL TYPE	RADIUS ON DIAMOND	INCLUDED ANGLE ON DIAMOND	TOOL LENGTH	
<b>DI =</b>	05 = .005"	1 = 60°	138 = 1-3/8"	
	Natural	2 = 40°	175 = 1-3/4"	
	<b>Diamond</b>	15 = .015"		225 = 2-1/4"
		20 = .020"		
		25 = .025"		

EXAMPLE: DI 05 1 138

CONTACT YOUR NORTON REPRESENTATIVE FOR ALL YOUR NON-STOCK, CUSTOM CONFIGURATION QUESTIONS, REQUESTS FOR QUOTES, ETC.

## CLUSTER TOOLS

Norton Cluster Tools are designed specifically for straight face dressing of large diameter, coarse grit grinding wheels on single or double disc, centerless, or surface grinders.

### WHEEL FORMS DRESSED BY THESE TOOLS



CONVEX



TAPERED



## MULTI-POINT CLUSTER TOOLS

Multi-Point Cluster tools are typically used for straight face dressing on disc and centerless operations. For greatest efficiency, these tools should be mounted at a 15° angle so that three diamonds are in contact with the wheel face at all times. The tool should be rotated at frequent intervals. Not resettable.

BETTER				
DIAMONDS ON FACE	SHANK DIAMETER	TOOL LENGTH	PRODUCT #	NON-RESETTABLE UPC #
<b>STOCK MULTI-POINT CLUSTER TOOLS</b>				
7	7/16"	1-5/16"	NC7K7	66260195206

STANDARD PACKAGE = 1 TOOL

BEST				
DIAMONDS ON FACE	SHANK DIAMETER	TOOL LENGTH	PRODUCT #	NON-RESETTABLE UPC #
<b>NON-STOCK MULTI-POINT CLUSTER TOOLS</b>				
7	7/16"	1-5/16"	MP77	66260195205

STANDARD PACKAGE = 1 TOOL

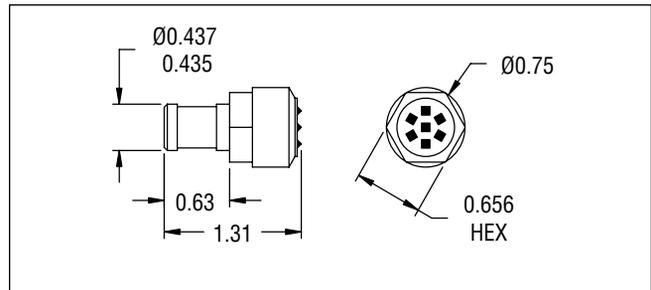

### WHEEL FORMS DRESSED BY THESE TOOLS



STRAIGHT



TAPERED

## DIA-PAK TOOLS

Dia-Pak tools are primarily used in straight face disc grinding, but are extremely versatile and may also be used in centerless and surface operations. Designed for maximum economy, three layers of diamond are carefully arranged so that a new layer is exposed before the previous layer is completely worn away. Not resettable.

BETTER					
FOR WHEEL DIAMETERS	DIAMONDS PER LAYER	SHANK DIAM.	TOOL LENGTH	PRODUCT #	NON-RESETTABLE UPC #
<b>STOCK DIA-PAK TOOLS</b>					
Up to 14"	5-4-5	7/16"	2"	DP20	66260195200
Up to 20"	7-6-7	7/16"	2"	DP30	66260195201
Any	7-6-7	7/16"	2"	DP35	66260195202

STANDARD PACKAGE = 1 TOOL

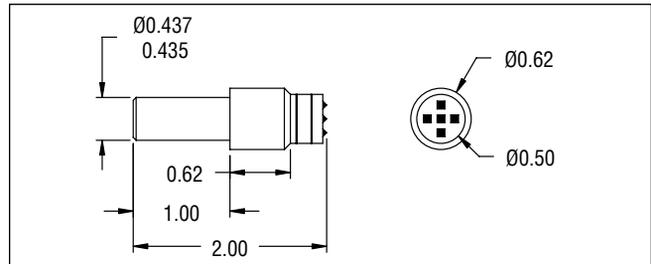

### WHEEL FORMS DRESSED BY THESE TOOLS



STRAIGHT



TAPERED

# TECHtip

## CLUSTER AND DIA-PAK TOOLS – STRAIGHT FACE DRESSING OF HARD / COARSE WHEELS:

- Tool should approach the wheel at a 15° angle and be rotated periodically to keep three diamonds in contact with the wheel at all times.
- Tools can also be used at a 90° to the wheel face.
- Multi-Point Cluster Tools should be rotated at frequent intervals.
- Infeed per pass should not exceed .0015" (.001" with Norton SG/Ceramic, Norton Quantum and Targa TG wheels).
- Use coolant whenever possible.
- These tools permit a faster traverse rate providing a freer cutting wheel than when dressed by a conventional single-point tool.

**ACCESSORIES**

Tool holders typically used in toolroom applications.



**TOOL HOLDER/HAND DRESSER**

Designed for use when offhand truing and dressing on tool and cutter, or benchstand grinders. This stock hand dresser will not rust, and is 10-1/2" long, with a hollow shaft that accepts any tool shank length from 3/4" to 9". The 1-3/4" diameter plastic knob ensures a firm grip. The collet accepts a 7/16" diameter tool shank.

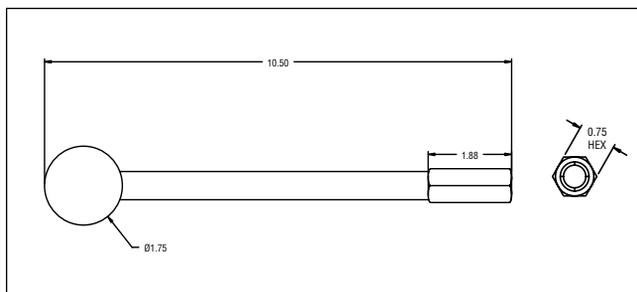

DESCRIPTION	UPC #
Hand Dresser	66260195020

**MACHINE TOOL HOLDER**

Designed to be mounted directly on the table of surface and tool grinders with a bolt or magnetic chuck, our stock machine dresser is positioned vertically with the tool positioned at a 15° drag angle.

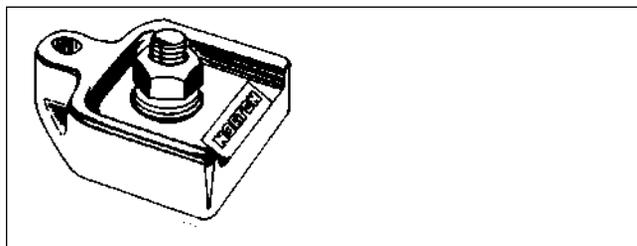

DESCRIPTION	UPC #
Machine Holder	66260195355



# DIAMOND TOOL RECOMMENDATIONS BY MACHINE TYPE

MANUFACTURER AND MACHINE TYPE		TOOL DRAWING	ORDERING SPECIFICATION		MANUFACTURER AND MACHINE TYPE		TOOL DRAWING	ORDERING SPECIFICATION	
			SINGLE POINT TOOL	MULTI-POINT TOOL				SINGLE POINT TOOL	MULTI-POINT TOOL
<b>AGATHON</b>			CD8515		<b>CHEVALIER</b>			CD-2221-RR	
<b>ALBERTSON &amp; CO; SIOUX GRINDERS</b>								CD-8346	
Valve Refacer 112 and 30013			CD402-1-5/8"	1R6 Special ME103738A	<b>DANOBAT</b>				ME162543
Valve Seat Grinder 1715-B and 30190			CD-1019	1R6 Special ME103743	<b>ESTARTA</b>			CD-2695-C	
Valve Seat Grinders			S-2621-C		<b>EXCELLO CORP.</b>				
		Please specify overall Length "L" availability;			Thread Grinder #31			NT-106 (48-4105)	3R806•
<b>BROWN &amp; SHARPE</b>					<b>FORTUNA</b>			CD-7512	
Plain Grinder #5			CD-1537R	2A6E7•	<b>G&amp;L WINSLOWMATIC</b>			CD-1733-JJ	
Surface Grinder			S-2639	1R6 Special ME103737	Internal Grinders #70, 72A, 73, 74, 78, 81 & 172			CD-441K-9	
<b>BRYANT CHUCKING GRINDER COMPANY</b>					<b>GLEASON WORKS</b>			S416	
Internal Grinders #4, 4B, 5, 5A, & 5B			NI21R4•	N.A.	<b>HEALD</b>				
Internal Grinder #112			CD-225	N.A.	Internal Grinders			CD-260-8	N.A.
			CDP-10179		Internal Thread			N121Q7•	N.A.
<b>CEDAR RAPIDS "KWIKWAY"</b>					Rotary Surface Grinders #22, 25A & 261			CD-193	1R6J7
Valve Refacer			CD401-2-3/8"	N.A.					
Valve Seat Grinder			CD-1799	1R6 Special ME103740					
Valve Seat Grinder			S-2622-A	1R6 Special ME103745A					

• INDICATES A STOCK ITEM.

# DIAMOND TOOL RECOMMENDATIONS BY MACHINE TYPE

MANUFACTURER AND MACHINE TYPE	TOOL DRAWING	ORDERING SPECIFICATION		MANUFACTURER AND MACHINE TYPE	TOOL DRAWING	ORDERING SPECIFICATION	
		SINGLE POINT TOOL	MULTI-POINT TOOL			SINGLE POINT TOOL	MULTI-POINT TOOL
<b>JONES &amp; LAMSON</b>				<b>KOYO</b>			
Thread Grinder		NT1L4 (NX-57475)	3R8L4 & 3R12L4*		CD-5827		
Model E Form Grinder		JONES & LAMSON FORM THREAD GRINDER Specify included angle and radius on diamond.			CD-8334		
					S-2104-4		
<b>JONES &amp; SHIPMAN</b>		CD-7802-B			CD-6768		
<b>KELLENBERGER</b>		DI251138		<b>LANDIS TOOL CO.</b>		BCSG10M7*	
		CD-6200-V		<b>MICRON</b>		CD-5804	
		CD-441F-12		<b>MITSUBISHI</b>		CD-6475	
		CD-6783			CD-8514		
				<b>MOORE PANTOGRAPH</b>		CD-4895-12	
<b>K.O. LEE COMPANY</b>		BCSG5M6*		<b>MOORE CONTOUR DRESSER</b>		MOORE CONTOUR DRESSER +Specify included angle and radius on diamond.	
		CD-6996-A					
		S-2104-4		<b>NORMAC &amp; HERTLIEN</b>		CD-4895-12	
		S-2623					

\* INDICATES A STOCK ITEM.

# DIAMOND TOOL RECOMMENDATIONS BY MACHINE TYPE

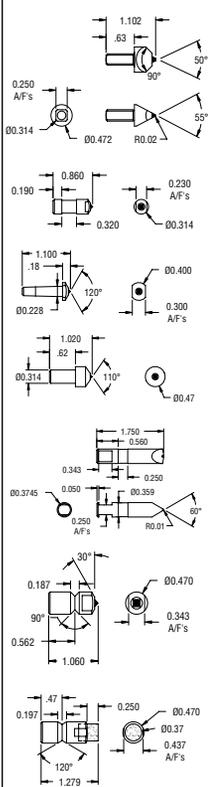
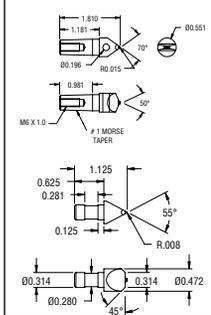
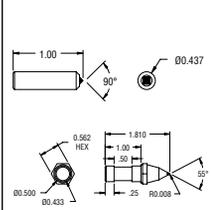
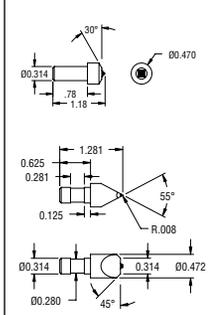
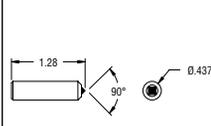
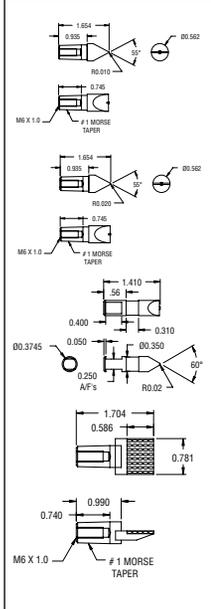
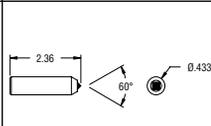
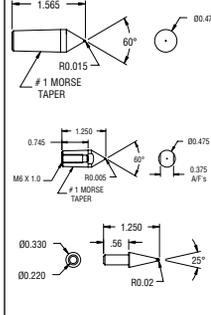
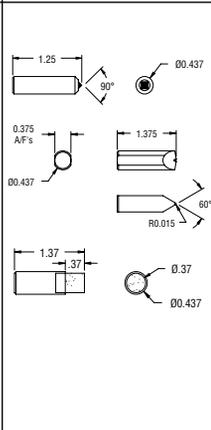
MANUFACTURER AND MACHINE TYPE	TOOL DRAWING	ORDERING SPECIFICATION SINGLE POINT TOOL	ORDERING SPECIFICATION MULTI-POINT TOOL	MANUFACTURER AND MACHINE TYPE	TOOL DRAWING	ORDERING SPECIFICATION SINGLE POINT TOOL	ORDERING SPECIFICATION MULTI-POINT TOOL
<b>OKAMOTO</b>		<p>CD-8907</p> <p>CD-7994</p> <p>CD-5711-A</p> <p>CD-591-48</p> <p>CD-2221-U</p> <p>CD-3230</p> <p>ME124878-B</p>		<b>SCHAUDT</b>		<p>CD-7513</p> <p>CD-5357</p>	
<b>OKUMA</b>		<p>CD-361-AA</p> <p>CD-5147</p>		<b>SHIGIYA</b>		<p>CD-6222</p> <p>CD-6167</p>	
<b>OLIVER INSTRUMENT</b>		<p>CD-441G-25</p>		<b>STUDER</b>		<p>CD-6501</p> <p>CD-6501-A</p> <p>CD-7819</p> <p>CD-6426</p>	
<b>OVERBECK</b>		<p>CD-7541-A</p>				<p>CD-5315</p> <p>CD-7503</p> <p>CD-6405</p> <p>CD-6797</p>	
<b>ROYALMASTER</b>		<p>CD-441G-34</p> <p>CD-6653</p> <p>ME85710-F</p> <p>CD-8695</p>				<p>CD-6797</p>	

# DIAMOND TOOL RECOMMENDATIONS BY MACHINE TYPE

MANUFACTURER AND MACHINE TYPE	TOOL DRAWING	ORDERING SPECIFICATION SINGLE POINT TOOL	MULTI-POINT TOOL
<b>STUDER</b> (CONTINUED)		CD-6852	
		CX-1421	
		CX-1421-A	
		CX-1421-B	
<b>TOYODA</b>		CD-5963	
		CD-8033	
<b>WASINO</b>		D1101175	
		D1052175	
<b>WELDON</b>		CD-7147-1	
<b>WILSON HARDNESS TESTER</b>		CD-1552	



## COMPETITIVE TOOL ANALYSIS

A competitive tool analysis is the best method of supplying you with a product that meets your quality needs at a competitive price. Our analysis of your present unused tool may include removal of the diamond for expert evaluation. Norton will review your application information to determine if a different dressing tool design could improve your process and/or provide a quote for comparable product.

## CUSTOM MADE DRESSING TOOLS

The Norton Diamond Tool Team maintains a file of over 50,000 different diamond tool designs, cross-referenced by machine builder, tool type, and other manufacturers.

New applications create the need for new tools. Our experienced staff is unmatched in designing and building custom tools.

When ordering custom tools, it is important that the following be supplied:

### Workpiece Considerations

- Part forms
- Tolerances of part
- Surface finish required

### Machine Data

- Tool holder size and shape
- Length of tool
- Method of fastening tool
- Contact position of tool to wheel face
- Method of generating form (from bar or CNC)
- Whether tool is used wet or dry
- Dressing parameters

### Wheel Specifics

- Size (diameter x width)
- Grit size
- Abrasive type
- Total wheel specification is desirable

## WE OFFER A FULL LINE OF CUSTOM-MADE STATIONARY TOOLS

For on-line tool selection, visit [nortonindustrial.com/ez-tool](http://nortonindustrial.com/ez-tool) or contact your Norton representative.



# FLIESEN STATIONARY DIAMOND DRESSING TOOLS



## OPEN OR CLOSED DRESSING... YOU CAN COUNT ON FLIESEN TOOLS

Whether dressing a wheel OPEN or CLOSED you can count on Fliesen tools. Open wheels (sharp, free-cutting abrasive grains are exposed) are created by increasing the speed a Fliesen tool moves across the wheel when dressing. Generally considered the most favorable wheel conditioning, open wheels avoid workpiece burn while maximizing a wheel's ability to remove metal quickly when grinding.

Slowing a Fliesen tool as it moves across the wheel creates a closed wheel condition (abrasive grains are smoother, less sharp), a very helpful condition when trying to lower part surface finish readings.

## THE BENEFITS OF FLIESEN TOOLS

### Spend More Time Grinding

Single point, chisel, and cone point tools require operator attention to ensure proper tool rotation at regular intervals. Fliesen tools require no adjustments. Simply install the tool, dress the wheel to break it in, and the tool will do the rest. Operators spend more time grinding – rather than making non-productive dressing adjustments.

### Longer Tool Life

Expect long life when using a Fliesen tool. Other stationary tools, made with a single diamond stone, develop flat spots (“wear flats”) over time – which create chatter and burn. Fliesen tools use hand-set, fine diamond grit, eliminating the creation of wear flats.

### Reliable and Cost-Effective

Harder, H-bond metal formulation Fliesen tools have been specifically engineered to efficiently dress durable silicon carbide and ceramic wheels. Our new Furioso Fliesen tools have a unique bond system developed for optimal performance when dressing Norton Quantum (NQ) ceramic wheels. W-bond Fliesen tools are designed for conventional aluminum oxide wheels.

## FLIESEN TOOL CONFIGURATIONS

Fliesen tools are available in two basic tool configurations. The most common is a plate configuration, which is somewhat rectangular-shaped with a mounting hole. Fliesen Shank Tool configurations are plates mounted in shanks of varying sizes and shapes. Most grinding machines accommodate one or the other tool configuration. To find the correct tool configuration for your machine, check the existing dressing tool, refer to the Tools by Machine Type Index in this catalog, or consult your grinding machine manual.

## CHOOSING THE CORRECT FLIESEN TOOL

Using the chart below, find your desired wheel form – then locate the preferred diamond position. Next, find the correct tool configuration for your machine: plate or shank tool. Follow down that column to find the Fliesen page for your plate or standard shank tool configuration. Go to the appropriate page. Locate the corresponding zone for your wheel diameter and width on the graph. Find that zone number in the UPC chart. Next, moving to the right, find your wheel abrasive type and grit size. Locate the UPC number for your Fliesen tool.

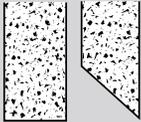
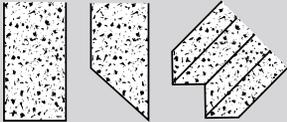
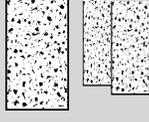
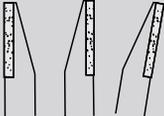
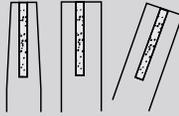
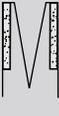
DESIRED WHEEL FORM					
DIAMOND POSITIONS	 BLADE ONLY FR	 SIDE-MOUNTED FRS, FAS, FBS, FCS, FDS	 CENTER-MOUNTED FAS, FBS, FCS & FDS	 DOUBLE-SIDED FCSD & FDSD	 TWIN FDST, FSST, AND 1TFAS
TOOL CONFIGURATION					
PLATES	 CONSULT CUSTOMER SERVICE	PAGE 115 – 116	PAGE 116	PAGE 117	PAGE 115, 117
SHANK TOOLS	 PAGE 118	PAGE 115, 118 CONSULT CUSTOMER SERVICE	CONSULT CUSTOMER SERVICE	CONSULT CUSTOMER SERVICE	CONSULT CUSTOMER SERVICE

# SPECcheck

## MATCH THE CORRECT FLIESEN TOOL TO YOUR GRINDING WHEEL ABRASIVE

Use Fliesen tools with W-bond specifications for aluminum oxide wheels. W-bonded tools have the standard matrix of metal surrounding the diamonds. When dressing more durable abrasive wheels, such as silicon carbide and ceramic, use our H-bonded tools, or our new Furioso tools for Norton Quantum and other ceramic wheels, which are harder and more durable. Markings on the tool indicate the tool's bond matrix. Use the right bond matrix for your abrasive application, as each is specifically engineered to perform best on the abrasive it was designed for. The catalog product charts are categorized by abrasive and appropriate bond.

## FLIESEN TOOL MOUNTING GUIDELINES

1. Be sure to mount the tool correctly. Tool contact surface should be perpendicular to wheel.

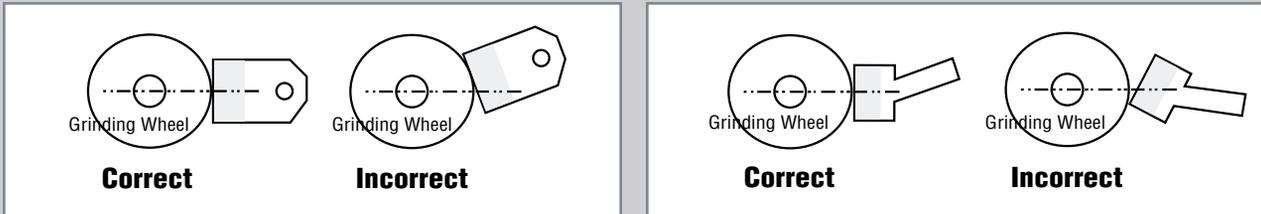

2. Mount tool with diamond on trailing edge whenever possible as shown below.

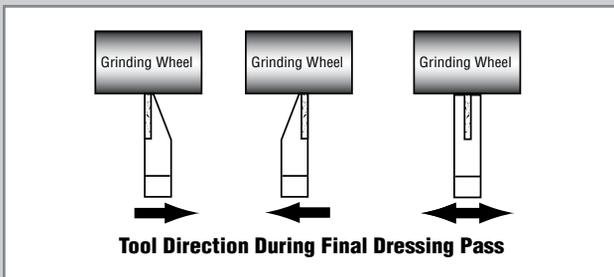

## RECOMMENDED DRESSING PARAMETERS

There are three elements to proper dressing. Dresser Infeed is the amount of material the tool takes off per dress pass. Dress Traverse Rate is the speed at which the tool moves across the wheel. The third element is the Number of Passes across the wheel. We recommend the following:

### 1. Dresser Infeed

Dresser Infeed (amount tool moves into wheel) = .0005" to .0015" (.012mm – .038mm) for aluminum oxide wheels. Reduce by 25% when dressing silicon carbide or ceramic wheels.

### 2. Dress Traverse Rate

Select a Lead Value based on desired Surface Finish and run the formula below.

FINISH	LEAD VALUE (PER WHEEL REVOLUTIONS)
For Coarse Finish (approx. 64 rms)	.023" to .030" (.58mm – .76mm)
For Medium Finish (approx. 32 rms)	.013" to .022" (.33mm – .57mm)
For Fine Finish (approx 16 rms)	.006" to .012" (.15mm – .33mm)

### DRESS TRAVERSE FORMULA:

$$\text{Lead Value} \times \text{Wheel Speed (RPM)} = \text{Inches/Minutes (mm/Min)}$$

### 3. Number of Passes

One is required. Take more as needed to restore form or finish. Dress passes should always remove material from the wheel. If your tool is not cutting the wheel, it is dulling the wheel. Avoid dry or dead dress passes which do not remove wheel material.

## MAXIMIZING TOOL LIFE AND EFFECTIVENESS

The goal of dressing is to maximize the wheel's sharpness – for maximum metal removal when grinding. This is best accomplished through disciplined dressing speeds and feeds. Taking too much off per dress pass, and/or moving the tool too slowly across the wheel will cause the Fliesen tool to overheat, breakdown and wear prematurely. To maximize the tool's effectiveness, increase the dress traverse rate as high as possible while maintaining part print surface finish requirements.



# SPECcheck

## TOOL BREAK-IN

The diamonds in new Fliesen tools are often covered by the metal surrounding them and should undergo a break-in process before production dressing. This process ensures that the effective diamond layer is properly exposed. This is achieved by taking 3 – 5 dress passes at .005" depth of cut (on wheel radius) at normal dress traverse rates.

Because the diamonds are set at a slight angle, it is normal for some diamonds to remain buried in the metal after the break-in and during production dressing.

## COOLANT SPECIFICATIONS

Fliesen tools should be used with coolant whenever possible, to avoid overheating and shortening tool life. We recommend at least a .50" (12.7mm) diameter stream of steady coolant be positioned so that the air barrier surrounding the wheel "pulls" the coolant (through the dressing action). A coolant velocity of 3% to 5% faster than the wheel's surface feet per minute works well, or enough pressure to penetrate the air barrier surrounding the wheel as it spins.

## RADIUS DRESSING CAPABILITIES

For most angle-head truing and dressing applications, Fliesen tools can provide uniform and consistent radius-generation second only to chisel and cone point type tools. When dressing very intricate forms, tool selection should be driven by the smallest concave or fillet radius needed to generate the desired radii, rather than wheel grit size. Refer to the chart below for radius dressing capabilities by diamond size.

FLIESEN TOOL	DESCRIPTION	TYPICAL FILLET RADIUS (MIGHT VARY W/ APPLICATION AFTER BREAK-IN)		DRESSING WIDTH OF FLIESEN
FRS/FDS/FCS/FBS/FAS/1TFAS	75	.014	.008	.020
FRS/FDS/FCS/FBS/FAS/1TFAS	90	.014	.012	.028
FDS/FCS/FBS/FAS/1TFAS	115	.020	.018	.040
FDS/FCS/FBS/FAS/1TFAS	140	.022	.020	.044

## STANDARD FLIESEN PLATE DRAWINGS

<p>Plate or Special Mounts FCS – W Bond Only</p>	<p>Plate- or Shank-Mounted FCS – H Bond</p>	<p>Plate or Special Mounts FDS – W Bond Only</p>	<p>Plate- or Shank-Mounted FDS – H Bond</p>
<p>Plate- or Shank-Mounted FRS – W Bond Only</p>	<p>Plate- or Shank-Mounted Twin FCS – W Bond Only</p>	<p>Plate Only, With Adapter Twin FCS – W Bond Only</p>	<p>Typical Shank-Mounted Design</p>

**STANDARD HOLE SIZE FOR ALL TOOLS = 6.1MM.**

**SEE THE FURIOSO TOOL PLATE DRAWINGS AND AVAILABILITY, FOR DRESSING NEW CERAMICS, SUCH AS NORTON QUANTUM WHEELS, ON THE FOLLOWING PAGES.**

**PLEASE CONTACT YOUR NORTON REPRESENTATIVE FOR ALL YOUR NON-STOCK CUSTOM CONFIGURATION QUESTIONS, REQUEST FOR QUOTES, ETC.**

The new generation of highly wear-resistant stationary diamond dressing tools for dressing modern ceramic abrasives.

## Performance Advantage

Furioso vs. Standard Blade

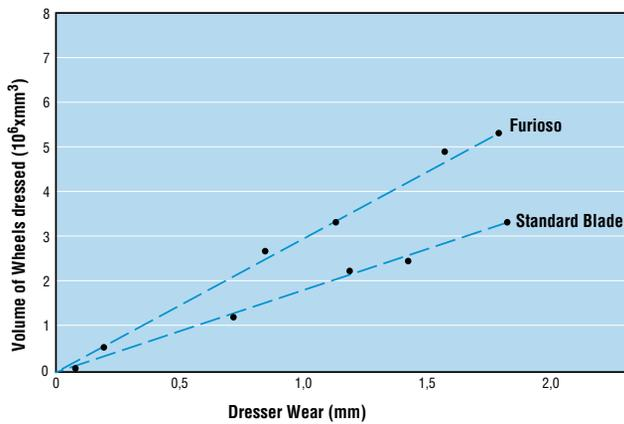

## BEST

## FURIOSO TOOLS – FOR OPTIMUM PERFORMANCE ON NORTON QUANTUM CERAMIC WHEELS

### FEATURES

- The optimized combination of diamond quality, bond and setting pattern when dressing Norton Quantum (NQ) ceramic grinding wheels

### BENEFITS

- Improved wear-resistance
- Excellent dressing behavior
- Constant surface roughness



## Standard Furioso Plate Drawings

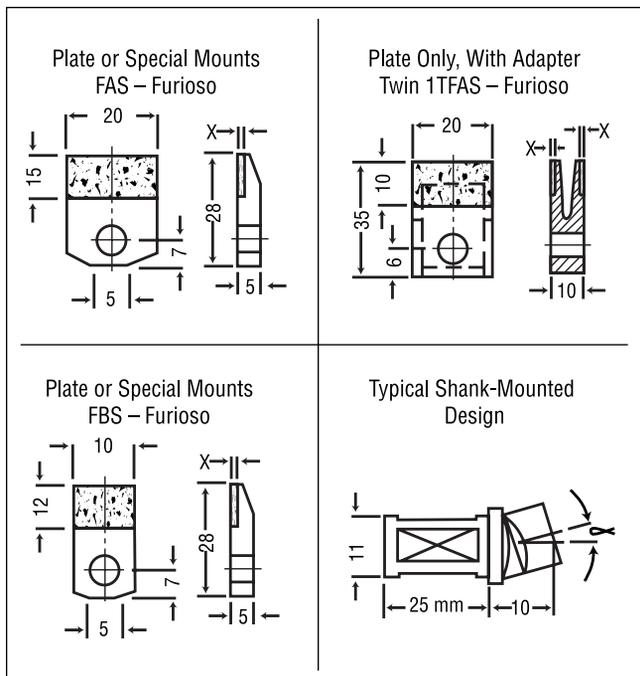

## FURIOSO PLATES; SIDE-MOUNTED AND TWIN

Use the Wheel/Tool Graph to identify your grinding wheel's Zone number, and the chart below to find the Furioso tool for your application.

### Wheel / Furioso Tool Graph

Select Zone based on wheel diameter and width

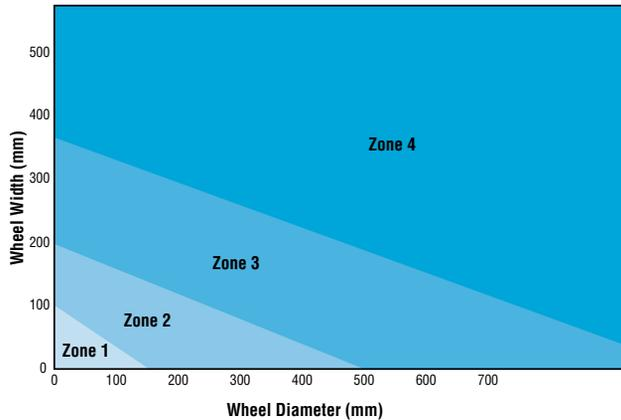

ZONE # / SERIES		WHEEL GRIT SIZE	BEST		
			NORTON QUANTUM NQ CERAMIC WHEELS		
			TOOL #	UPC #	DESCRIPTION
<b>SIDE-MOUNTED</b>					
	<b>Zone 2</b>	36 - 54	DT1463	69014122948	FBS 140 Furioso
		FBS Series			
		54 - 80	DT1462	69014122947	FBS 115 Furioso
		80 - 120	DT1461	69014122946	FBS 90 Furioso
		120 - 180	DT1460	69014122944	FBS 75 Furioso
	<b>Zone 3</b>	36 - 54	DT1467	69014122952	FAS 140 Furioso
		FAS Series			
		54 - 80	DT1466	60157690579	FAS 115 Furioso
		80 - 120	DT1465	60157693885	FAS 90 Furioso
		120 - 180	DT1464	69014122950	FAS 75 Furioso
<b>TWIN</b>					
	<b>Zone 4</b>	36 - 54	DT1471	69014122956	1TFAS 140 Furioso
		1TFAS Series			
		54 - 80	DT1470	69014122955	1TFAS 115 Furioso
		80 - 120	DT1469	69014122954	1TFAS 90 Furioso
		120 - 180	DT1468	69014122953	1TFAS 75 Furioso

• ALL FURIOSO PLATES SHOWN SHIP IN 10 BUSINESS DAYS FROM RECEIPT OF ORDER.

### BLADE SIZE

DESCRIPTION	DIMENSION
1 FBS	10 mm thick, 15 mm usable length
2 FAS	20 mm thick, 15 mm usable length
3 TFAS	Twin blade with cooling duct

### DIAMOND GRIT SIZE

DESCRIPTION	FEPA
140	D1181
115	D1001
90	D711
75	D501

## FURIOSO SHANK TOOLS

Made-to-order Furioso shank tools are also available. Ask our Norton representative for ordering assistance.

### Side-Mounted Diamond Sections

Tools are available in different offset positions and angles.



OFFSET LEFT, SPECIFY ANGLE AMOUNT



ZERO OFFSET



OFFSET RIGHT, SPECIFY ANGLE AMOUNT



DIAMOND TIPPED LEFT, SPECIFY ANGLE



DIAMOND TIPPED RIGHT, SPECIFY ANGLE



THERE ARE MANY DIFFERENT DIAMONDS MAKING UP A SINGLE PLATE AS THIS CUT-AWAY VIEW SHOWS.

# FLIESEN PLATES: SIDE- AND CENTER-MOUNTED

Use the Wheel/Tool Graph to identify your grinding wheel's Zone number, and the chart below to find the Fliesen tool for your .

## Wheel / Fliesen Tool Graph

Select Zone based on wheel diameter and width

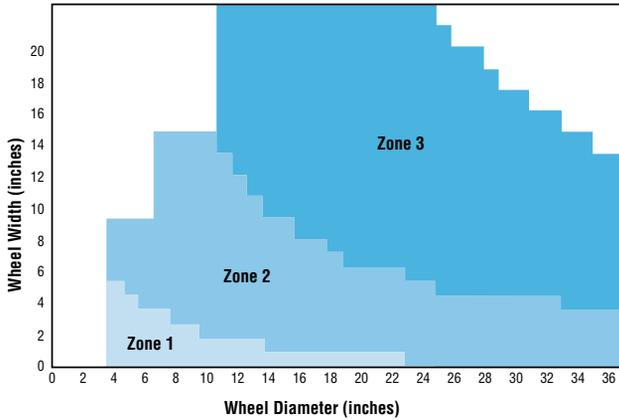

ZONE # / SERIES	WHEEL GRIT SIZE	BEST ALUMINUM OXIDE WHEELS (W-BOND)			BEST CERAMIC (SG & NQ), & S/C WHEELS (H-BOND)		
		TOOL #	UPC #	DESCRIPTION	TOOL #	UPC #	DESCRIPTION
<b>SIDE-MOUNTED</b>							
 Zone 1 FRS Series	60 and Finer	DT0691	66260388852#	FRS180W	H-bond Tools are not available in these configurations		
 Zone 2 FDS Series	36-46	DT0037	69014185737#	FDS140W			
	54-60	DT0035	69014185736#	FDS115W			
	80-100	DT0033	69014185735#	FDS90W			
	120 and Finer	DT0031	69014185747#	FDS75W			
 Zone 3 FCS Series	36-46	DT0027	69014185716*	FCS140W			
	54-60	DT0025	69014185718#	FCS115W			
	80-100	DT0023	69014185732#	FCS90W			
	120 and Finer	DT0021	69014185746#	FCS75W			
<b>CENTER-MOUNTED</b>							
 Zone 2 FDS Series	36-46	DT0246	66260114826*	FDS140W	DT0038	66260387481#	FDS140H
	54-60	DT0245	66260386661#	FDS115W	DT0036	66260387592#	FDS115H
	80-100	DT0244	66260389753#	FDS90W	DT0034	69014185738#	FDS90H
	120 and Finer	DT0243	66260114690#	FDS75W	DT0032	66260387692#	FDS75H
 Zone 3 FCS Series	36-46	DT0233	66260382018*	FCS140W	DT0028	66260387133#	FCS140H
	54-60	DT0232	66260386801#	FCS115W	DT0026	69014185734#	FCS115H
	80-100	DT0231	66260385394#	FCS90W	DT0024	66260384227#	FCS90H
	120 and Finer	DT0230	66260114271*	FCS75W	DT0022	66260385384#	FCS75H
<b>FLIESEN PLATE MOUNTING MECHANISMS</b>							
 Fliesen Plate Holder Tool No.: DT0085 UPC #: 66260100681	 Fliesen Plate Holder Tool #: DT0069 UPC #: 66260389554 .437" diameter shank (tool not included).						

# PLATES SHOWN SHIP 2-3 DAYS FROM RECEIPT OF ORDER.

\* MADE-TO-ORDER; CONTACT YOUR NORTON REPRESENTATIVE FOR CURRENT LEAD-TIMES.

**PLEASE CONTACT YOUR NORTON REPRESENTATIVE FOR ALL YOUR NON-STOCK CUSTOM CONFIGURATION QUESTIONS, REQUEST FOR QUOTES, ETC.**

# FLIENEN PLATES: DOUBLE-SIDED AND TWIN

Use the Wheel/Tool Graph to identify your grinding wheel's Zone number, and the chart below to find the Fliesen tool for your application.

## Wheel / Fliesen Tool Graph

Select Zone based on wheel diameter and width

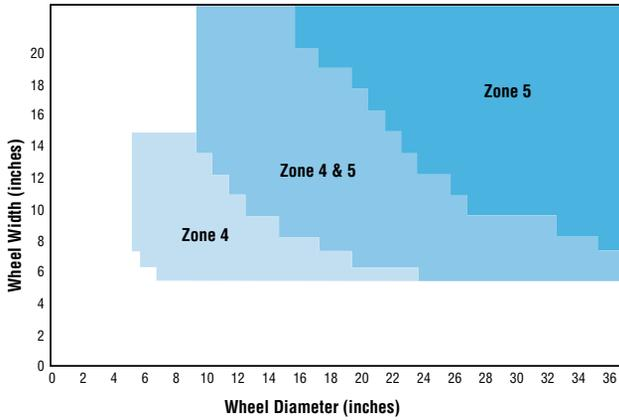

		BEST			CERAMIC (SG & NQ), & S/C WHEELS (H-BOND)		
ZONE # / SERIES	WHEEL GRIT SIZE	ALUMINUM OXIDE WHEELS (W-BOND) TOOL #	UPC #	DESCRIPTION	TOOL #	UPC #	DESCRIPTION
<b>DOUBLE-SIDED</b>							
	<b>Zone 4</b> FSDS Series	54-60	DT0741	69014123079*	FDSD115W	H-bond Tools are not available in these configurations	
							
	<b>Zone 5</b> FCSD Series	54-60 80-100	DT0259 DT0411	66260112980* 66260111494*	FCSD115W FCSD90W		
							
<b>TWIN</b>							
	<b>Zone 4</b> FDST Series	54-60	DT0969	66260391021*	FDST115W		
							
	<b>Zone 5</b> FCST Series	54-60 80-100 120 and Finer	DT0442 DT0439 DT0733	66260112444# 66260114225# 69014123080*	FCST115W FCST90W FCST75W		
							

# PLATES SHOWN SHIP 2-3 DAYS FROM RECEIPT OF ORDER.

\* MADE-TO-ORDER; CONTACT YOUR NORTON REPRESENTATIVE FOR CURRENT LEAD-TIMES.

## TECHtip

Because Double-sided and Twin Fliesen tools have twice the surface contact area on the wheel as single-sided Fliesen tools, they should traverse across the wheel nearly twice as fast. Also, with twice the diamond volume as single-sided Fliesen tools, they last twice as long.

# FLIESEN SHANK TOOLS: BLADES AND SIDE-MOUNTED

Use the Wheel/Tool Graph to identify your grinding wheel's Zone number, and the chart below to find the Fliesen tool for your application.

## Wheel / Fliesen Tool Graph

Select Zone based on wheel diameter and width

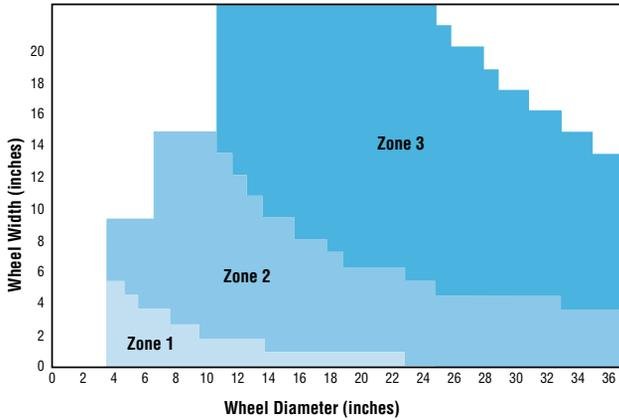

		<b>BEST</b>							
		ALUMINUM OXIDE WHEELS (W-BOND)			CERAMIC (SG & NQ), & S/C WHEELS (H-BOND)				
		ZONE # / SERIES	WHEEL GRIT SIZE	TOOL #	UPC #	DESCRIPTION	TOOL #	UPC #	DESCRIPTION
<b>BLADES</b>									
		<b>Zone 1</b> FR Series 0° Offset Angle	60 and Finer	DT1101-A	66260329400	FR180W	H-bond Tools are not available in these configurations		
		<b>Zone 1</b> FR Series 15° Offset Angle	60 and Finer	DT1101	66260100826	FR180W			

• SHANK TOOLS SHOWN SHIP IN 10 BUSINESS DAYS FROM RECEIPT OF ORDER.

## Side-Mounted Diamond Sections

Tools are available in different offset positions and angles. Contact your Norton representative for ordering assistance.



OFFSET LEFT,  
SPECIFY ANGLE  
AMOUNT

ZERO OFFSET

OFFSET RIGHT,  
SPECIFY ANGLE  
AMOUNT

## Tipping the Diamond Plates on Shank Tools

Diamond sections can be tipped right or left. Contact your Norton representative for ordering assistance.



DIAMOND  
TIPPED LEFT,  
SPECIFY ANGLE

DIAMOND  
TIPPED RIGHT,  
SPECIFY ANGLE



THERE ARE  
MANY DIFFERENT  
DIAMONDS MAKING  
UP A SINGLE PLATE  
AS THIS CUT-AWAY  
VIEW SHOWS.

SEE OUR FURIOSO SHANK TOOLS ON PAGE 114 FOR DRESSING MODERN CERAMIC WHEELS.

PLEASE CONTACT YOUR NORTON REPRESENTATIVE FOR ALL YOUR NON-STOCK CUSTOM CONFIGURATION QUESTIONS, REQUEST FOR QUOTES, ETC.

**TRIANGLE INSERT DRESSING TOOLS**

Designed for special machines requiring insert style tool configurations.

MACHINE TYPE	INNER CIRCLE (IC)	TIP RADIUS	BEST	
			ALL ABRASIVE TYPES TOOL #	UPC #
Studer	3.48mm	0.005"	P00590	66260166700 •
Tschudin		0.010"	P00585	66260102369 •
Vomard		0.020"	P00591	66260166174 •
Kellenberger	3.93mm	0.005"	P00830	60157625728*

• THESE TOOLS SHIP IN 10 BUSINESS DAYS FROM RECEIPT OF ORDER  
\* MADE-TO-ORDER; CONTACT YOUR NORTON REPRESENTATIVE FOR CURRENT LEAD-TIMES.



**DIAMOND TRUING PAD**

Designed for truing cBN grinding wheels on surface grinders. Use with coolant. Subsequent stick dressing is required to ensure proper wheel conditioning prior to grinding.

TOOL #	UPC #
DT0084	66260110959

**THIS TRUING PAD IS A STOCK ITEM**

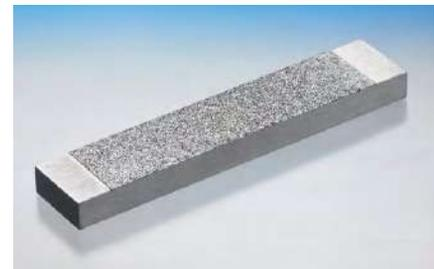

**TECHtip**

**ACCIDENTALLY DAMAGE YOUR FLIESEN TOOL?**

Simply dress the wheel several times with your Fliesen Tool to wear away the damaged layer, and uncover a new layer of sharp diamonds. Unlike damaged chisel tools and cone point tools, which must be removed, inspected, and often replaced, Fliesen Tools can be quickly restored to optimum working order.

**PLEASE CONTACT YOUR NORTON REPRESENTATIVE FOR ALL YOUR NON-STOCK CUSTOM CONFIGURATION QUESTIONS, REQUEST FOR QUOTES, ETC.**

# TOOLS BY MACHINE TYPE INDEX

Use the Wheel/Tool Graph to identify your grinding wheel's Zone number, and the chart below to find the Fliesen tool for your application.

## Wheel / Fliesen Tool Graph

Select Zone based on wheel diameter and width

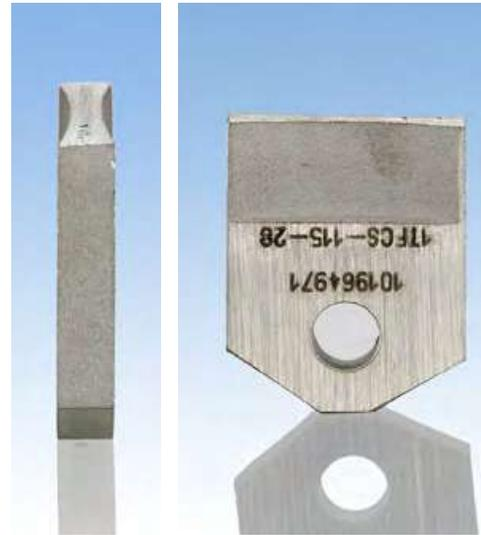
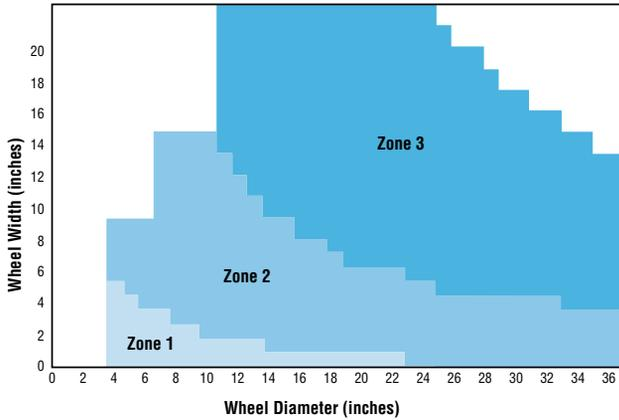

ZONE # / ANGLE	WHEEL GRIT SIZE/RADIUS	BEST			BEST			
		ALUMINUM OXIDE WHEELS (W-BOND)			CERAMIC (SG & NQ), & S/C WHEELS (H-BOND)			
		TOOL #	UPC #	DESCRIPTION	TOOL #	UPC #	DESCRIPTION	
<b>CINCINNATI CENTERLESS</b>								
	<b>Zone 2</b> 0° Offset Angle	36-46	DT0246	66260114826	FDS140W	DT0038	66260387481	FDS140H
		54-60	DT0245	66260386661	FDS115W	DT0036	66260387592	FDS115H
		80-100	DT0244	66260389753	FDS90W	DT0034	69014185738	FDS90H
		120 and Finer	DT0243	66260114690	FDS75W	DT0032	66260387692	FDS75H
	<b>Zone 3</b> 0° Offset Angle	36-46	DT0233	66260382018	FCS140W	DT0028	66260387133	FCS140H
		54-60	DT0232	66260386801	FCS115W	DT0026	69014185734	FCS115H
		80-100	DT0231	66260385394	FCS90W	DT0024	66260384227	FCS90H
		120 and Finer	DT0230	66260114271	FCS75W	DT0022	66260385384	FCS75H
	<b>Zone 2</b> 15° Offset Angle	36-46	DT0434	66260100744	FDS140W	DT0218	60157603873	FDS140H
		54-60	DT0234	66260100716	FDS115W	DT0217	66260100708	FDS115H
		80-100	DT0183	66260100687	FDS90W	DT0216	66260100707	FDS90H
		120 and Finer	DT0433	66260100984	FDS75W	DT0215	66260102106	FDS75H
	<b>Zone 3</b> 15° Offset Angle	36-46	DT0437	66260100747	FCS140W	DT0210	66260100703	FCS140H
		54-60	DT0436	66260100746	FCS115W	DT0209	66260100702	FCS115H
		80-100	DT0251	66260100722	FCS90W	DT0208	66260100701	FCS90H
		120 and Finer	DT0435	66260100745	FCS75W	DT0207	66260100700	FCS75H
<b>SCHAUDT</b>								
	Chisel Tool 70° Included Angle .50ct	.016" Radius	TP1082	66260329714				

CONTACT YOUR NORTON REPRESENTATIVE FOR CURRENT LEAD-TIMES.

**PLEASE CONTACT YOUR NORTON REPRESENTATIVE FOR ALL YOUR NON-STOCK CUSTOM CONFIGURATION QUESTIONS, REQUEST FOR QUOTES, ETC.**



# TOOLS BY MACHINE TYPE INDEX

Use the Wheel/Tool Graph to identify your grinding wheel's Zone number, and the chart below to find the Fliesen tool for your application.

## Wheel / Fliesen Tool Graph

Select Zone based on wheel diameter and width

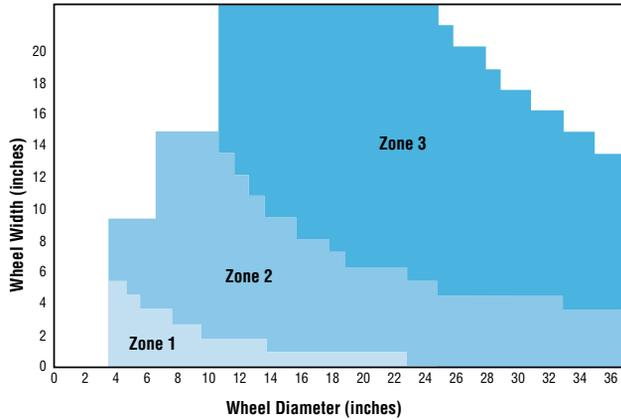

		BEST				BEST		
ZONE # / OFFSET ANGLE		WHEEL GRIT SIZE/RADIUS	ALUMINUM OXIDE WHEELS (W-BOND)			CERAMIC (SG & NQ), & S/C WHEELS (H-BOND)		
			TOOL #	UPC #	DESCRIPTION	TOOL #	UPC #	DESCRIPTION
<b>OKUMA</b>								
		<b>Zone 2</b>						
		54-60	DT0489	66260101515	FDS115W			
		80-100	DT0511	66260101453	FDS90W			
		120 and Finer	DT1126	60157604435	FDS75W	DT0523	66260102408	FDS75H
		<b>Zone 3</b>						
		54-60	DT0589	60157604098	FCS90W			
		5° Offset Angle						
		<b>Cone Point Tools</b>						
		55° Included	TP1077	66260329663				
		Angle	TP1078	66260329670				
		70° Included	TP1079	66260329675				
		Angle .50ct	TP1080	66260329680				
<b>TOYODA</b>								
		<b>Zone 2</b>						
		36-46	DT0690	60157604139	FDS140W	DT0557	66260100803	FDS140H
		10° Offset Angle						
		54-60	DT0527	66260101271	FDS115W	DT0529	66260102768	FDS115H
		80-100	DT0488	66260101495	FDS90W	DT0528	66260101454	FDS90H
		120 and Finer	DT0526	66260100786	FDS75W	DT0513	66260100779	FDS75H
		<b>Zone 3</b>						
		36-46	DT0428	66260100742	FCS140W	DT0432	60157604008	FCS140H
		10° Offset Angle						
		54-60	DT0427	66260100741	FCS115W			
		80-100	DT0426	66260100740	FCS90W			
		120 and Finer	DT0425	60157604003	FCS75W	DT0429	66260100743	FCS75H

CONTACT YOUR NORTON REPRESENTATIVE FOR CURRENT LEAD-TIMES.

# TOOLS BY MACHINE TYPE INDEX

Use the Wheel/Tool Graph to identify your grinding wheel's Zone number, and the chart below to find the Fliesen tool for your application.

## Wheel / Fliesen Tool Graph

Select Zone based on wheel diameter and width

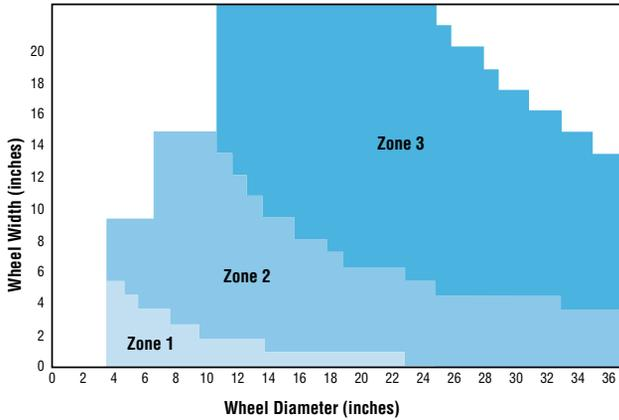

	ZONE # / SHANK/ANGLE	WHEEL GRIT SIZE/RADIUS	BEST			BEST		
			ALUMINUM OXIDE WHEELS (W-BOND)			CERAMIC (SG & NQ), & S/C WHEELS (H-BOND)		
STUDER			TOOL #	UPC #	DESCRIPTION	TOOL #	UPC #	DESCRIPTION
	Zone 2	54-60	DT0444	66260100751	FDS115W	DT1049	66260166122	FDS115H
	19mm Long	80-100	DT0474	66260100759	FDS90W	DT1047	66260101129	FDS90H
	MT1 Shank	120 and Finer	DT0443	66260100936	FDS75W			
	Zone 3	54-60	DT0558	66260100805	FCS115W	DT1005	60157604315	FCS115H
	19mm Long							
	Zone 2	54-60	DT0761	66260320977	FDS115W	DT0550	60157604072	FDS115H
	40mm Long	80-100	DT0595	66260100816	FDS90W			
	Shank	120 and Finer	DT0547	66260100798	FDS75W			
	Zone 3	54-60	DT0051	66260100670	FCS115W			
	40mm Long	80-100				DT0287	66260100731	FCS90H
	Chisel Tool	.005" Radius	TP1083	66260329681				
	Zone 3	.008" Radius	TP1084	66260329688				
	55° Offset Angle	.010" Radius	TP1085	66260329696				
	.50 ct	.015" Radius	TP1086	66260329705				
		.020" Radius	TP1087	66260329709				
	Zone 2	36-46	DT1114	60157604423	FDS140W			
	10° Offset Angle	54-60	DT1113	66260100820	FDS115W			
		80-100	DT1112	66260100821	FDS90W			
		120 and Finer	DT1111	60157604420	FDS75W			

CALL YOUR NORTON REPRESENTATIVE FOR CURRENT LEAD-TIMES.

# FLIESEN TOOL COMPETITIVE CROSS REFERENCE

CINCINNATI TOOL #	NORTON TOOL #
CM300	DT233
CM300-7/16-1	DT424
CM300-7/16-1-0	DT424
CM300-7/16-1-10	DT428
CM300-7/16-1-15	DT437
CM301	DT232
CM301-7/16-1	DT423
CM301-7/16-1-0	DT423
CM301-7/16-1-10	DT276
CM301-7/16-1-15	DT436
CM301N	DT1385
CM302	DT231
CM302-7/16-1-10	DT426
CM302-7/16-1-15	DT251
CM303	DT230
CM303-7/16-1	DT421
CM303-7/16-1-0	DT421
CM303-7/16-1-10	DT425
CM303-7/16-1-15	DT435
CM304	DT411
CM304-7/16-1-15	DT441
CM306	DT85

CINCINNATI TOOL #	NORTON TOOL #
CM308	DT439
CM309	DT442
CM334	DT246
CM334-7/16-1	DT420
CM334-7/16-1-0	DT420
CM334-7/16-1-10	DT690
CM334-7/16-1-15	DT434
CM335	DT245
CM335-7/16-1	DT419
CM335-7/16-1-0	DT419
CM335-7/16-1-10	DT527
CM335-7/16-1-15	DT234
CM336	DT244
CM336-7/16-1	DT290
CM336-7/16-1-0	DT290
CM336-7/16-1-10	DT488
CM336-7/16-1-15	DT183
CM337	DT243
CM337-7/16-1	DT296
CM337-7/16-1-0	DT296
CM337-7/16-1-10	DT526
CM337-7/16-1-15	DT433

CINCINNATI TOOL #	NORTON TOOL #
CM338	DT28
CM338-7/16-1	DT206
CM338-7/16-1-0	DT206
CM338-7/16-1-10	DT432
CM338-7/16-1-15	DT210
CM339	DT26
CM339-7/16-1	DT205
CM339-7/16-1-0	DT205
CM339-7/16-1-15	DT209
CM340	DT24
CM340-7/16-1	DT204
CM340-7/16-1-0	DT204
CM340-7/16-1-15	DT208
CM341	DT22
CM341-7/16-1	DT203
CM341-7/16-1-0	DT203
CM341-7/16-1-10	DT429
CM341-7/16-1-15	DT207
CM358	DT38
CM358-7/16-1	DT214
CM358-7/16-1-0	DT214
CM358-7/16-1-10	DT557

CINCINNATI TOOL #	NORTON TOOL #
CM358-7/16-1-15	DT218
CM359	DT36
CM359-7/16-1	DT213
CM359-7/16-1-0	DT213
CM359-7/16-1-10	DT529
CM359-7/16-1-15	DT217
CM360	DT34
CM360-7/16-1	DT212
CM360-7/16-1-0	DT212
CM360-7/16-1-10	DT528
CM360-7/16-1-15	DT216
CM361	DT32
CM361-7/16-1	DT211
CM361-7/16-1-0	DT211
CM361-7/16-1-10	DT513
CM361-7/16-1-15	DT215
CM370	DT259
CM370-7/16-1	DT476
CM370-7/16-1-0	DT476
CM370-7/16-1-10	DT262
CM370-7/16-1-15	DT261

**NORTON ELECTROPLATED  
DIAMOND AND CBN PRODUCTS**



## ENGINEERING TO MEET DIVERSE DEMANDS

Our extensive offering of stock diamond and cBN electroplated products has been engineered to meet the diverse demands of traditional and emerging tool and die, ceramic, and composite applications.

Applications include small hole/ID grinding, deburring, cleaning, honing, precision drilling, forming dies and molds, routing, reaming, blending radii, notching and cutting-off with saw blades in ceramic, tool and die, and composite applications.

### IDENTIFYING TARGET MARKETS:

An industry key is provided beside each product. This key identifies markets that typically use the product:

TARGET MARKET SYMBOLS:



### PLACING AN ORDER

Our many products and services can be ordered through our network of quality industrial distributors. To ensure accurate and rapid order fulfillment, please provide your distributor with:

- **UPC Number:** the 11-digit number found in each product availability chart in the first left-hand column
- **Product Description:** such as a cBN mounted point or a diamond wheel
- **Dimensions and Wheel Shape:** such as 6 x 7/16 x 1-1/4 Type 6A2C diamond wheel
- **Product Specification:** such as 100 grit, diamond
- **Order quantity**

### STRIP AND REPLATE SERVICES AND CUSTOM-MADE PRODUCTS

Ask Customer Service for information and quotations on our complete strip and replate services on many electroplated products.

And, when your application calls for a product design not available from our standard offering, Norton can provide a made-to order product engineered to your drawings.

### CONTACT YOUR NORTON DISTRIBUTOR OR NORTON CUSTOMER SERVICE

*US Customer Service*  
Phone Toll Free: (800) 551-4413  
Fax Toll Free: (800) 551-4416  
Local Phone: (254) 918-2313  
Local Fax: (254) 918-2314

*Canadian Customer Service*  
Telephone: (800) 263-6565  
Fax: (800) 561-9490

### TECHNICAL INFORMATION

To ensure correct usage and maximum performance of our products, refer to the following General Information and Tech Tip pages.

### ABRASIVE APPLICATIONS

Although diamond and cBN (cubic Boron Nitride) are both superabrasives, the use of diamond and cBN varies, depending upon the materials to be ground.

#### Diamond Grinds:

- Cemented carbide
- Glass
- Ceramics
- Fiberglass
- Plastics
- Composites
- Abrasives
- Stone
- Electronic components and materials

#### cBN Grinds:

- High-speed tool steels
- Die steel
- Hardened carbon steels
- Hardened stainless steels
- Alloy steels
- Aerospace alloys
- Abrasion-resistant ferrous materials

In general, cBN is used to grind ferrous materials. Diamond is used to grind non-ferrous materials, because it reacts with iron.

### SURFACE FINISH

Use this chart only as a guide. Surface finish is affected by a number of variables: machine type and condition, type of material, coolant, wheel speed, bond system, etc.

#### Expected RMS Finish

GRIT SIZE	ELECTROPLATED
80	90-125
100	64-90
120	48-64
150	32-48
180	24-32
220	20-24
240	16-20
320	16-20
400	14-20
500	12-13
600	12
800	12
1200	12
1500	12

**MADE-TO-ORDER ELECTROPLATED PRODUCT GUIDE**

The stock electroplated products offered on the following pages have been engineered to meet the diversity of demands typical in today's manufacturing environment.

When special forms, shapes and configurations are required, Norton electroplated diamond and cBN products can be fabricated in almost any geometry. In addition, strip and replate services are available.

Customers may prefer to manufacture their own preforms/blanks for custom products and in many cases this can reduce cost and lead times.

The instructions below detail the necessary allowances for each grit size. Please refer to these whenever manufacturing blanks.

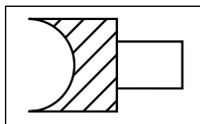

**Area to be plated (female radius)**

Female radius must be larger than the finished size required.

Example – If a .500 female radius is required with 60/80 grit, then the blank should be manufactured .011 larger = .511

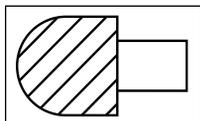

**Area to be plated (male radius)**

A male radius must be smaller than the finished size required.

Example – If a .500 male radius is required with 60/80 grit, then the blank should be manufactured .011 smaller = .489

**GRIT SIZE ALLOWANCE FOR  
PLATED PRODUCTS**

GRIT SIZE	ALLOWANCE/ PARTICLE SIZE
20/30	.035
30/40	.025
40/50	.018
60/80	.011
80/100	.008
100/120	.007
120/140	.006
140/170	.005
170/200	.004
200/230	.0035
270/325	.003
4.5 Micron – 400	.0025
30 Micron – 600	.0016
15 Micron – 1200	.001

**THIS SHOULD BE USED AS A GUIDE WHEN  
MANUFACTURING BLANKS TO BE PLATED WITH  
DIAMOND OR CBN.**

**TECHtip**

**COOLANTS**

Although coolants may not be necessary, using a coolant produces superior surface finishes, a longer tool life, higher performance, and reduces tool loading.

**FEEDS**

Suggested feeds for jig or internal grinding are from .0002" – .0004" per pass.

**SPEEDS**

**Maximum Operating Speeds (MOS)**

Never exceed the maximum operating speed marked on the superabrasive product being used.

**Electroplated Products: 25,000 SFPM**

Maximum speeds of Mounted Point wheels are a function of the length of overhang and size of the product. Refer to "Safe Operating Speeds" in form #2872, provided with your product.

**Recommended Operating Speeds**

The preceding speed is the maximum safe speed and not necessarily the most efficient. Superabrasive products operate most effectively at speeds lower than the maximum. The following are general recommendations. cBN products, in many cases, are used effectively at higher speeds.

**Electroplated Diamond Products: 5,000 to 10,000 SFPM**

**Electroplated cBN Products: 8,000 to 10,000 SFPM**

**Calculating Operating Speed**

The following formula may be used to quickly calculate wheel speed:

RPM = Revolutions Per Minute  
SPFM = Surface Feet Per Minute

To convert SFPM to RPM: (Multiply SFPM x 3.82) divided by wheel diameter in inches

## ELECTROPLATED MOUNTED POINTS

### DIAMOND AND cBN MOUNTED POINTS ● ▲

FEATURES	BENEFITS
■ Nickel alloy matrix	■ Tough, durable bond
■ Single layer of abrasive	■ Economical
■ Exposed particles	■ Aggressive cutting action
■ Variety of tools and grit sizes available as stock	■ Satisfies most tool and die and deburring requirements
■ Mandrels are made of high-speed tool steel	■ Withstand operating pressure

Use Norton diamond mounted points for precise, small hole, jig and internal grinding of carbide, ceramics, sapphire, glass, and a variety of tough, super alloys.

For grinding tough, high carbon, high chrome steel, use cBN mounted points.

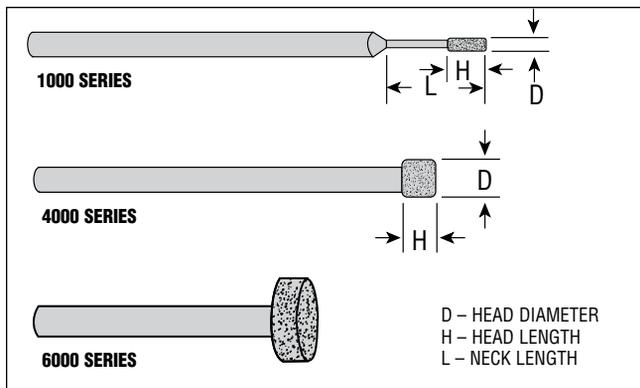

UPC #	PRODUCT #	HEAD DIAMETER INCHES	HEAD LENGTH	NECK LENGTH	GRIT SIZE
<b>1000 SERIES – DIAMOND</b>					
<b>1/8" Shank x 2-1/4" Overall Length</b>					
66260392429	1016FD	.016	.079	1/8	200
66260392432	1020MD	.020	.079	1/8	150
66260392431	1020FD	.020	.079	1/8	200
66260392436	1025MD	.025	.079	1/8	150
66260392435	1025FD	.025	.079	1/8	200
66260392440	1030MD	.030	.079	1/4	150
66260392439	1030FD	.030	.079	1/4	200
66260392445	1035CD	.035	.118	1/4	100
66260392444	1035MD	.035	.118	1/4	150
66260392443	1035FD	.035	.118	1/4	200
66260392451	1040CD	.040	.118	1/4	100
66260392450	1040MD	.040	.118	1/4	150
66260392449	1040FD	.040	.118	1/4	200
66260392457	1045CD	.045	.118	1/4	100
66260392456	1045MD	.045	.118	1/4	150
66260392455	1045FD	.045	.118	1/4	200
66260392463	1050CD	.050	.118	1/2	100
66260392462	1050MD	.050	.118	1/2	150
66260392461	1050FD	.050	.118	1/2	200
66260392469	1050LCD	.050	.118	1	100
66260392468	1050LMD	.050	.118	1	150
66260392467	1050LFD	.050	.118	1	200
66260392475	1055CD	.055	.118	1/2	100
66260392474	1055MD	.055	.118	1/2	150
66260392473	1055FD	.055	.118	1/2	200
66260392481	1060CD	.060	.157	1/2	100

+ AVAILABLE AS STOCK WHILE SUPPLIES LAST; THEN AVAILABLE AS NON-STOCK.  
\* NON-STOCK; CONTACT YOUR NORTON REPRESENTATIVE FOR CURRENT LEAD-TIMES.

TARGET MARKET SYMBOLS:



UPC #	PRODUCT #	HEAD DIAMETER INCHES	HEAD LENGTH	NECK LENGTH	GRIT SIZE
<b>1000 SERIES – DIAMOND (CONT'D)</b>					
<b>1/8" Shank x 2-1/4" Overall Length</b>					
66260392480	1060MD	.060	.157	1/2	150
66260392479	1060FD	.060	.157	1/2	200
66260392487	1060LCD	.060	.157	1	100
66260392486 +	1060LMD	.060	.157	1	150
66260392485 *	1060LFD	.060	.157	1	200
66260392493 *	1065CD	.065	.157	1/2	100
66260392492	1065MD	.065	.157	1/2	150
66260392491	1065FD	.065	.157	1/2	200
66260392499	1070CD	.070	.157	1/2	100
66260392498	1070MD	.070	.157	1/2	150
66260392497	1070FD	.070	.157	1/2	200
66260392505 +	1070LCD	.070	.157	1	100
66260392504 *	1070LMD	.070	.157	1	150
66260392503 *	1070LFD	.070	.157	1	200
66260392511	1075CD	.075	.157	1/2	100
66260392510	1075MD	.075	.157	1/2	150
66260392509	1075FD	.075	.157	1/2	200
66260392517	1080CD	.080	.157	1/2	100
66260392516	1080MD	.080	.157	1/2	150
66260392515	1080FD	.080	.157	1/2	200
66260392523	1080LCD	.080	.157	1	100
66260392522 *	1080LMD	.080	.157	1	150
66260392521	1080LFD	.080	.157	1	200
66260392529	1085CD	.085	.157	1/2	100
66260392528	1085MD	.085	.157	1/2	150
66260392527 *	1085FD	.085	.157	1/2	200
66260392535	1090CD	.090	.157	1/2	100
66260392534	1090MD	.090	.157	1/2	150
66260392533	1090FD	.090	.157	1/2	200
66260392541	1090LCD	.090	.157	1	100
66260392540	1090LMD	.090	.157	1	150
66260392547	1095CD	.095	.157	1/2	100
66260392546	1095MD	.095	.157	1/2	150
66260392545 +	1095FD	.095	.157	1/2	200
66260392553	1100CD	.100	.157	1/2	100
66260392552	1100MD	.100	.157	1/2	150
66260392551	1100FD	.100	.157	1/2	200
66260392559 +	1100LCD	.100	.157	1	100
66260392565	1105CD	.105	.157	1/2	100
66260392564 *	1105MD	.105	.157	1/2	150
66260392563	1105FD	.105	.157	1/2	200
66260392571 *	1105LCD	.105	.157	1	100

CONTINUED

**ELECTROPLATED MOUNTED POINTS**

**DIAMOND AND cBN MOUNTED POINTS ● ▲**

UPC #	PRODUCT #	HEAD DIAMETER INCHES	HEAD LENGTH	NECK LENGTH	GRIT SIZE
<b>1000 SERIES – DIAMOND (CONT'D)</b>					
<b>1/8" Shank x 2-1/4" Overall Length</b>					
66260392570 *	1105LMD	.105	.157	1	150
66260392569 *	1105LFD	.105	.157	1	200
66260392577	1110CD	.110	.157	1/2	100
66260392576	1110MD	.110	.157	1/2	150
66260392575 *	1110FD	.110	.157	1/2	200
66260392583	1110LCD	.110	.157	1	100
66260392581 *	1110LFD	.110	.157	1	200
66260392589	1115CD	.115	.157	1/2	100
66260392588	1115MD	.115	.157	1/2	150
66260392595	1120CD	.120	.157	1/2	100
66260392594	1120MD	.120	.157	1/2	150
66260392593	1120FD	.120	.157	1/2	200
66260392601	1125CD	.125	.157	1/2	100
66260392600	1125MD	.125	.157	1/2	150
66260392599	1125FD	.125	.157	1/2	200
66260392607	1130CD	.130	.197	1	100
66260392606	1130MD	.130	.197	1	150
66260392605 *	1130FD	.130	.197	1	200
66260392613	1135CD	.135	.236	N/A	100
66260392612	1135MD	.135	.236	N/A	150
66260392611	1135FD	.135	.236	N/A	200
66260392619	1140CD	.140	.236	N/A	100
66260392618 *	1140MD	.140	.236	N/A	150
66260392617 *	1140FD	.140	.236	N/A	200
66260392625	1156CD	.156	.236	N/A	100
66260392624	1156MD	.156	.236	N/A	150
66260392623	1156FD	.156	.236	N/A	200
66260392731 +	1171CD	.171	.236	N/A	100
66260392730	1171MD	.171	.236	N/A	150
66260392737	1187CD	.187	.312	N/A	100
66260392736 *	1187MD	.187	.312	N/A	150
66260392735	1187FD	.187	.312	N/A	200
66260392743 *	1203CD	.203	.312	N/A	100
66260392742	1203MD	.203	.312	N/A	150
66260392741	1203FD	.203	.312	N/A	200
66260392749 *	1218CD	.218	.312	N/A	100
66260392748	1218MD	.218	.312	N/A	150
66260392747	1218FD	.218	.312	N/A	200
66260392755	1250CD	.250	.312	N/A	100
66260392754	1250MD	.250	.312	N/A	150
66260392753	1250FD	.250	.312	N/A	200
66260363450	W10MD	.750	.035	N/A	150
<b>1000 SERIES – cBN</b>					
<b>1/8" Shank x 2-1/4" Overall Length</b>					
66260392430 *	1016FC	.016	.079	1/8	200
66260392434	1020MC	.020	.079	1/8	150
66260392433 *	1020FC	.020	.079	1/8	200
66260392438 *	1025MC	.025	.079	1/8	150
66260392437 *	1025FC	.025	.079	1/8	200
66260392442	1030MC	.030	.079	1/4	150
66260392441 +	1030FC	.030	.079	1/4	200
66260392448 *	1035CC	.035	.118	1/4	100
66260392446 *	1035FC	.035	.118	1/4	200
66260392454 *	1040CC	.040	.118	1/4	100
66260392453	1040MC	.040	.118	1/4	150

CONTINUED

UPC #	PRODUCT #	HEAD DIAMETER INCHES	HEAD LENGTH	NECK LENGTH	GRIT SIZE
<b>1000 SERIES – cBN (CONT'D)</b>					
<b>1/8" Shank x 2-1/4" Overall Length</b>					
66260392460	1045CC	.045	.118	1/4	100
66260392459 *	1045MC	.045	.118	1/4	150
66260392458 *	1045FC	.045	.118	1/4	200
66260392466	1050CC	.050	.118	1/2	100
66260392465	1050MC	.050	.118	1/2	150
66260392464	1050FC	.050	.118	1/2	200
66260392472 *	1050LCC	.050	.118	1	100
66260392471 *	1050LMC	.050	.118	1	150
66260392478 *	1055CC	.055	.118	1/2	100
66260392477 *	1055MC	.055	.118	1/2	150
66260392484	1060CC	.060	.157	1/2	100
66260392483	1060MC	.060	.157	1/2	150
66260392482	1060FC	.060	.157	1/2	200
66260392490 *	1060LCC	.060	.157	1	100
66260392489 *	1060LMC	.060	.157	1	150
66260392488 *	1060LFC	.060	.157	1	200
66260392496	1065CC	.065	.157	1/2	100
66260392494 *	1065FC	.065	.157	1/2	200
66260392502	1070CC	.070	.157	1/2	100
66260392501	1070MC	.070	.157	1/2	150
66260392500	1070FC	.070	.157	1/2	200
66260392508 *	1070LCC	.070	.157	1	100
66260392507 *	1070LMC	.070	.157	1	150
66260392506 *	1070LFC	.070	.157	1	200
66260392514	1075CC	.075	.157	1/2	100
66260392513 *	1075MC	.075	.157	1/2	150
66260392512	1075FC	.075	.157	1/2	200
66260392520	1080CC	.080	.157	1/2	100
66260392519 *	1080MC	.080	.157	1/2	150
66260392518 *	1080FC	.080	.157	1/2	200
66260392526 +	1080LCC	.080	.157	1	100
66260392525 *	1080LMC	.080	.157	1	150
66260392524 *	1080LFC	.080	.157	1	200
66260392532	1085CC	.085	.157	1/2	100
66260392531	1085MC	.085	.157	1/2	150
66260392538	1090CC	.090	.157	1/2	100
66260392537	1090MC	.090	.157	1/2	150
66260392536	1090FC	.090	.157	1/2	200
66260392544	1090LCC	.090	.157	1	100
66260392543	1090LMC	.090	.157	1	150
66260392542 *	1090LFC	.090	.157	1	200
66260392550 *	1095CC	.095	.157	1/2	100
66260392549 +	1095MC	.095	.157	1/2	150
66260392548 *	1095FC	.095	.157	1/2	200
66260392556	1100CC	.100	.157	1/2	100
66260392555 +	1100MC	.100	.157	1/2	150
66260392554	1100FC	.100	.157	1/2	200
66260392562 *	1100LCC	.100	.157	1	100
66260392561	1100LMC	.100	.157	1	150
66260392568	1105CC	.105	.157	1/2	100
66260392567	1105MC	.105	.157	1/2	150
66260392566 *	1105FC	.105	.157	1/2	200
66260392574 *	1105LCC	.105	.157	1	100
66260392573 *	1105LMC	.105	.157	1	150
66260392572 *	1105LFC	.105	.157	1	200

CONTINUED

+ AVAILABLE AS STOCK WHILE SUPPLIES LAST; THEN AVAILABLE AS NON-STOCK.  
\* NON-STOCK; CONTACT YOUR NORTON REPRESENTATIVE FOR CURRENT LEAD-TIMES.

TARGET MARKET SYMBOLS:





**ELECTROPLATED MOUNTED POINTS**

**DIAMOND AND cBN MOUNTED POINTS ● ▲**

UPC #	PRODUCT #	HEAD DIAMETER INCHES	HEAD LENGTH	NECK LENGTH	GRIT SIZE
<b>1000 SERIES – cBN (CONT'D)</b>					
<b>1/8" Shank x 2-1/4" Overall Length</b>					
66260392580	1110CC	.110	.157	1/2	100
66260392579 *	1110MC	.110	.157	1/2	150
66260392578	1110FC	.110	.157	1/2	200
66260392586 *	1110LCC	.110	.157	1	100
66260392584 *	1110LFC	.110	.157	1	200
66260392592 *	1115CC	.115	.157	1/2	100
66260392591 *	1115MC	.115	.157	1/2	150
66260392590 *	1115FC	.115	.157	1/2	200
66260392598	1120CC	.120	.157	1/2	100
66260392597 *	1120MC	.120	.157	1/2	150
66260392596 *	1120FC	.120	.157	1/2	200
66260392604	1125CC	.125	.157	1/2	100
66260392603	1125MC	.125	.157	1/2	150
66260392602	1125FC	.125	.157	1/2	200
66260392610	1130CC	.130	.197	1	100
66260392609 *	1130MC	.130	.197	1	150
66260392608	1130FC	.130	.197	1	200
66260392616	1135CC	.135	.236	N/A	100
66260392615	1135MC	.135	.236	N/A	150
66260392614 *	1135FC	.135	.236	N/A	200
66260392622	1140CC	.140	.236	N/A	100
66260392621 *	1140MC	.140	.236	N/A	150
66260392620 *	1140FC	.140	.236	N/A	200
66260392628	1156CC	.156	.236	N/A	100
66260392627	1156MC	.156	.236	N/A	150
66260392626	1156FC	.156	.236	N/A	200
66260392734	1171CC	.171	.236	N/A	100
66260392733	1171MC	.171	.236	N/A	150
66260392732 *	1171FC	.171	.236	N/A	200
66260392740	1187CC	.187	.312	N/A	100
66260392739	1187MC	.187	.312	N/A	150
66260392738	1187FC	.187	.312	N/A	200
66260392746 *	1203CC	.203	.312	N/A	100
66260392745	1203MC	.203	.312	N/A	150
66260392744 *	1203FC	.203	.312	N/A	200
66260392752	1218CC	.218	.312	N/A	100
66260392751	1218MC	.218	.312	N/A	150
66260392750 *	1218FC	.218	.312	N/A	200
66260392758	1250CC	.250	.312	N/A	100
66260392757	1250MC	.250	.312	N/A	150
66260392756 *	1250FC	.250	.312	N/A	200
<b>4000 SERIES – DIAMOND</b>					
<b>1/4" Shank x 3" Overall Length</b>					
66260392630	4156CD	.156	.250	1	100
66260392629	4156FD	.156	.250	1	200
66260392634	4187CD	.187	.250	1	100
66260392633	4187FD	.187	.250	1	200
66260392638	4203CD	.203	.250	1	100
66260392637+	4203FD	.203	.250	1	200
66260392642	4218CD	.218	.250	1	100
66260392641	4218FD	.218	.250	1	200
66260392646	4236CD	.236	.250	1	100
66260392645	4236FD	.236	.250	1	200
66260392650	4250CD	.250	.250	1	100
66260392649	4250FD	.250	.250	1	200
66260392654	4282CD	.282	.250	N/A	100
66260392653	4282FD	.282	.250	N/A	200
66260392658	4312CD	.312	.375	N/A	100

CONTINUED

UPC #	PRODUCT #	HEAD DIAMETER INCHES	HEAD LENGTH	NECK LENGTH	GRIT SIZE
<b>4000 SERIES – DIAMOND (CONT'D)</b>					
<b>1/4" Shank x 3" Overall Length</b>					
66260392657	4312FD	.312	.375	N/A	200
66260392662	4375CD	.375	.375	N/A	100
66260392661	4375FD	.375	.375	N/A	200
66260392666	4390CD	.390	.375	N/A	100
66260392665	4390FD	.390	.375	N/A	200
66260392670	4406CD	.406	.375	N/A	100
66260392669 *	4406FD	.406	.375	N/A	200
66260392674	4437CD	.437	.375	N/A	100
66260392673 *	4437FD	.437	.375	N/A	200
66260392678	4500CD	.500	.375	N/A	100
66260392677	4500FD	.500	.375	N/A	200
66260392682	4730CD	.730	.375	N/A	100
66260392681 *	4730FD	.730	.375	N/A	200
66260392685 *	4864FD	.864	.375	N/A	200
66260392690	41000CD	1.000	.375	N/A	100
66260392689	41000FD	1.000	.375	N/A	200
<b>4000 SERIES – cBN</b>					
<b>1/4" Shank x 3" Overall Length</b>					
66260392632	4156CC	.156	.250	1	100
66260392631	4156FC	.156	.250	1	200
66260392636	4187CC	.187	.250	1	100
66260392635	4187FC	.187	.250	1	200
66260392640	4203CC	.203	.250	1	100
66260392639	4203FC	.203	.250	1	200
66260392644	4218CC	.218	.250	1	100
66260392643	4218FC	.218	.250	1	200
66260392648	4236CC	.236	.250	1	100
66260392647	4236FC	.236	.250	1	200
66260392652	4250CC	.250	.250	1	100
66260392651	4250FC	.250	.250	1	200
66260392656	4282CC	.282	.250	N/A	100
66260392655	4282FC	.282	.250	N/A	200
66260392660	4312CC	.312	.375	N/A	100
66260392659	4312FC	.312	.375	N/A	200
66260392664	4375CC	.375	.375	N/A	100
66260392663	4375FC	.375	.375	N/A	200
66260392668	4390CC	.390	.375	N/A	100
66260392667+	4390FC	.390	.375	N/A	200
66260392672	4406CC	.406	.375	N/A	100
66260392671+	4406FC	.406	.375	N/A	200
66260392676	4437CC	.437	.375	N/A	100
66260392675	4437FC	.437	.375	N/A	200
66260392680	4500CC	.500	.375	N/A	100
66260392679	4500FC	.500	.375	N/A	200
66260392684	4730CC	.730	.375	N/A	100
66260392683	4730FC	.730	.375	N/A	200
66260392688 *	4864CC	.864	.375	N/A	100
66260392687 *	4864FC	.864	.375	N/A	200
66260392692	41000CC	1.000	.375	N/A	100
66260392691 *	41000FC	1.000	.375	N/A	200

**+ AVAILABLE AS STOCK WHILE SUPPLIES LAST; THEN AVAILABLE AS NON-STOCK.  
\* NON-STOCK; CONTACT YOUR NORTON REPRESENTATIVE FOR CURRENT LEAD-TIMES.**

TARGET MARKET SYMBOLS:



CERAMICS TOOL & DIE COMPOSITES

**ELECTROPLATED MOUNTED POINTS, MANDRELS AND TAPERED HONES**

**DIAMOND AND cBN MOUNTED POINTS ● ▲**

UPC #	PRODUCT #	HEAD DIAMETER INCHES	HEAD LENGTH	GRIT SIZE
<b>6000 SERIES – DIAMOND</b>				
<b>3/8" Shank x 3-3/4" Overall Length</b>				
66260392694	6406CD	.406	.375	80
66260392693	6406MD	.406	.375	150
66260392698	6437CD	.437	.375	80
66260392697	6437MD	.437	.375	150
66260392702	6500CD	.500	.375	80
66260392701	6500MD	.500	.375	150
66260392706	6562CD	.562	.375	80
66260392710	6625CD	.625	.375	80
66260392709	6625MD	.625	.375	150
66260392714 *	6687CD	.687	.375	80
66260392713 *	6687MD	.687	.375	150
66260392718	6750CD	.750	.375	80
66260392717	6750MD	.750	.375	150
66260392722 *	6875CD	.875	.400	80
66260392721	6875MD	.875	.400	150
66260392726	61000CD	1.000	.500	80
66260392725	61000MD	1.000	.500	150

UPC #	PRODUCT #	HEAD DIAMETER INCHES	HEAD LENGTH	GRIT SIZE
<b>6000 SERIES – cBN</b>				
<b>3/8" Shank x 3-3/4" Overall Length</b>				
66260392696	6406CC	.406	.375	80
66260392695	6406MC	.406	.375	150
66260392700	6437CC	.437	.375	80
66260392699	6437MC	.437	.375	150
66260392704	6500CC	.500	.375	80
66260392703	6500MC	.500	.375	150
66260392708	6562CC	.562	.375	80
66260392707 *	6562MC	.562	.375	150
66260392712	6625CC	.625	.375	80
66260392711	6625MC	.625	.375	150
66260392716	6687CC	.687	.375	80
66260392715	6687MC	.687	.375	150
66260392720	6750CC	.750	.375	80
66260392719	6750MC	.750	.375	150
66260392724	6875CC	.875	.400	80
66260392723 *	6875MC	.875	.400	150
66260392728	61000CC	1.000	.500	80
66260392727	61000MC	1.000	.500	150
<b>9000 SERIES – DIAMOND</b>				
<b>3/4" Shank x 3-3/4" Overall Length</b>				
66260308354	91000CD	1.000	.500	80

**cBN HEAVY STOCK REMOVAL MANDRELS ▲**

FEATURES	BENEFITS
■ Nickel alloy matrix	■ Tough, durable bond
■ Single layer of abrasive	■ Economical
■ Exposed particles	■ Aggressive cutting action
■ Super coarse abrasive grit	■ Long tool life

For heavy stock removal on jig, internal, and offhand operations on tool steels and hardened aerospace alloys.

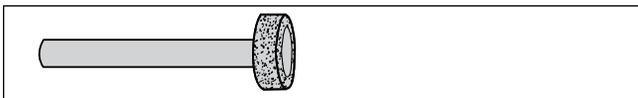

UPC #	PRODUCT #	HEAD DIAMETER	HEAD LENGTH	SHANK DIAMETER	OVERALL LENGTH	GRIT SIZE
<b>HSR SERIES – cBN</b>						
66260395426	HSR-1/4	1/4	1/4	3/8	3	60
66260395427+	HSR-5/16	5/16	5/16	3/8	3	60
66260395428	HSR-3/8	3/8	3/8	3/8	3	60
66260395429	HSR-1/2	1/2	3/8	3/8	3-1/2	60
66260395430 *	HSR-5/8	5/8	3/8	3/8	3-1/2	60
66260395431	HSR-3/4	3/4	3/8	3/8	3-1/2	60
66260395432	HSR-1	1	3/8	3/8	3-1/2	60

**DIAMOND TAPERED HONES FOR DRAWING DIES ● ▲ ■**

FEATURES	BENEFITS
■ Nickel alloy matrix	■ Tough, durable bond
■ Economical	■ Single layer of abrasive
■ Exposed particles	■ Aggressive cutting action

Used primarily for forming carbide drawing dies, but can be used for small hole honing in ceramics, fiberglass, plastics, and composite materials.

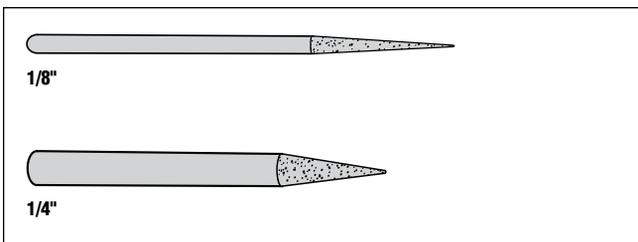

UPC #	PRODUCT #	INCLUDED ANGLE	SHANK DIAMETER	GRIT SIZE
<b>TAPERED HONES FOR DRAWING DIES – DIAMOND</b>				
<b>3" Overall Length</b>				
66260395540	TH12-6MD	6°	1/8	150
66260395541	TH12-8MD	8°	1/8	150
66260363371	TH25-12CD	12°	1/4	100
66260395542	TH12-12MD	12°	1/8	150
66260395543	TH25-12MD	12°	1/4	150
66260395544	TH25-14MD	14°	1/4	150
66260395545	TH25-16MD	16°	1/4	150

**+ AVAILABLE AS STOCK WHILE SUPPLIES LAST; THEN AVAILABLE AS NON-STOCK.  
\* NON-STOCK; CONTACT YOUR NORTON REPRESENTATIVE FOR CURRENT LEAD-TIMES.**

TARGET MARKET SYMBOLS:



## ELECTROPLATED MICRO DRILLS AND ROUTERS

### DIAMOND MICRO DRILLS ● ▲ ■

FEATURES	BENEFITS
■ Nickel alloy matrix	■ Tough, durable bond
■ Single layer of abrasive	■ Economical
■ Exposed particles	■ Aggressive cutting action

A modification of Norton mounted points, these tools are specifically designed for drilling holes in the .007" to .065" diameter range. Perfect for drilling sapphire and high density alumina ceramics for hybrid micro-circuit substrates.

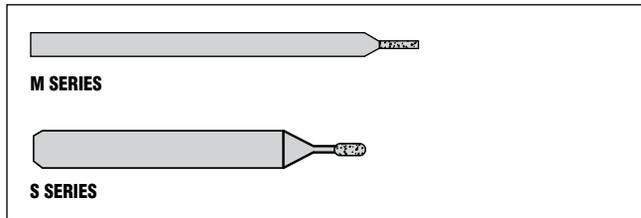

UPC #	PRODUCT #	DIAMETER INCHES	HEAD LENGTH	OVERALL LENGTH	GRIT SIZE
<b>M-SERIES MICRO DRILLS – DIAMOND</b>					
<b>Shank Diameter .040" (1MM)</b>					
66260395516	M7	.007	.028	11/16	600
66260395517	M10	.010	.049	11/16	400
66260395518	M12	.012	.056	13/16	325
66260395519	M15	.015	.077	13/16	325

**CAREFULLY-SIZED, UNIFORMLY-SHAPED DIAMOND PARTICLES ARE USED ON ALL M-SERIES DRILLS.**

UPC #	PRODUCT #	DIAMETER INCHES	HEAD LENGTH	OVERALL LENGTH	GRIT SIZE
<b>S-SERIES MICRO DRILLS – DIAMOND</b>					
<b>1/8" Shank x 1" Overall Length</b>					
66260395520	S16FD	.016	.062	.093	200
66260392841	S18FD	.018	.062	.125	200
66260395521	S20FD	.020	.062	.125	200
66260395522	S25FD	.025	.093	.156	200
66260395523	S30MD	.030	.093	.156	150
66260395524	S35MD	.035	.093	.187	150
66260395525	S40MD	.040	.125	.218	150
66260395526	S45CD	.045	.125	.218	100
66260395527	S50CD	.050	.125	.250	100
66260395528	S60CD	.060	.125	.312	100
66260395529	S65CD	.065	.125	.312	100

**RECOMMENDED FOR ADAPTING TO ULTRASONIC DRILL HEADS.**

### DIAMOND ROUTERS ● ■

FEATURES	BENEFITS
■ Nickel alloy matrix	■ Tough, durable bond
■ Single layer of abrasive	■ Economical
■ Exposed particles	■ Aggressive cutting action

Used with hand operated tools, drill presses, and milling machines. Ideal for routing and reaming the highly-abrasive materials of alumina, fiberglass, plastics, and other nonmetallic composite materials.

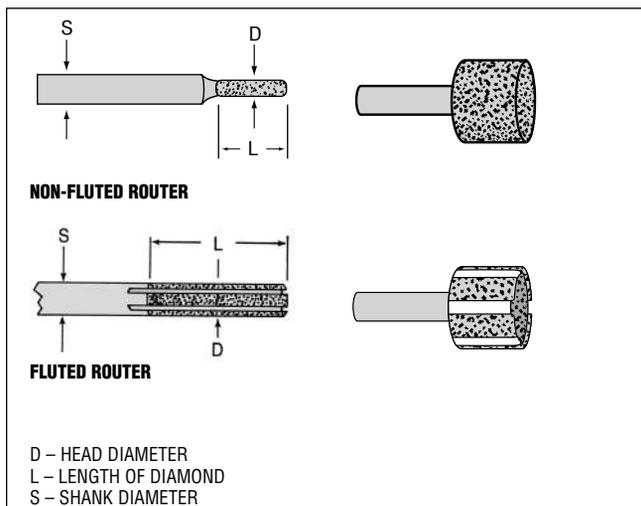

UPC #	PRODUCT #	HEAD DIAMETER	LENGTH OF DIAMOND	SHANK DIAMETER	OVERALL LENGTH	GRIT SIZE
<b>NON-FLUTED ROUTERS – DIAMOND</b>						
66260364305	* RNF1812CD	1/8	1/2	1/4	2-1/2	60
66260364304	+ RNF1810CD	1/8	1	1/4	2-1/2	60
66260364303	* RNF1412CD	1/4	1/2	1/4	2-1/2	40
66260364302	RNF1410CD	1/4	1	1/4	2-1/2	40
66260302707	* RNF3812CD	3/8	1/2	1/2	2-1/2	40
66260302709	* RNF3810CD	3/8	1	1/2	2-1/2	40
66260302711	* RNF1212CD	1/2	1/2	1/2	2-1/2	40
66260302712	* RNF1210CD	1/2	1	1/2	2-1/2	40
66260302714	* RNF3412CD	3/4	1/2	1/2	2-1/2	40
66260302717	* RNF3410CD	3/4	1	1/2	2-1/2	40
66260364301	* RNF1012CD	1	1/2	1/2	2-1/2	40
66260302720	* RNF1010CD	1	1	1/2	2-1/2	40
66260302721	* RNF11212CD	1-1/2	1/2	1/2	3	40
66260302725	* RNF2012CD	2	1/2	1/2	3	40
66260302728	* RNF2010CD	2	1	1/2	3	40
<b>FLUTED ROUTERS – DIAMOND</b>						
66260364310	RSF1812CD	1/8	1/2	1/4	2-1/2	60
66260364309	RSF1810CD	1/8	1	1/4	2-1/2	60
66260364308	RSF1412CD	1/4	1/2	1/4	2-1/2	40
66260364307	RSF1410CD	1/4	1	1/4	2-1/2	40
66260302710	* RSF3810CD	3/8	1	1/2	2-1/2	40
66260364306	* RSF1212CD	1/2	1/2	1/2	2-1/2	40
66260302713	* RSF1210CD	1/2	1	1/2	2-1/2	40
66260302715	RSF3412CD	3/4	1/2	1/2	2-1/2	40
66260302716	* RSF3410CD	3/4	1	1/2	2-1/2	40
66260302718	* RSF1012CD	1	1/2	1/2	2-1/2	40
66260302719	* RSF1010CD	1	1	1/2	2-1/2	40
66260302722	* RSF11212CD	1-1/2	1/2	1/2	3	40
66260302724	* RSF11210CD	1-1/2	1	1/2	3	40
66260302726	* RSF2012CD	2	1/2	1/2	3	40
66260302727	* RSF2010CD	2	1	1/2	3	40

**+ AVAILABLE AS STOCK WHILE SUPPLIES LAST; THEN AVAILABLE AS NON-STOCK. \* NON-STOCK; CONTACT YOUR NORTON REPRESENTATIVE FOR CURRENT LEAD-TIMES.**

TARGET MARKET SYMBOLS:



**ELECTROPLATED MOUNTED CONTOUR TOOLS**

**DIAMOND AND cBN MOUNTED CONTOUR TOOLS ● ▲ ■**

FEATURES	BENEFITS
■ Nickel alloy matrix	■ Tough, durable bond
■ Single layer of abrasive	■ Economical
■ Exposed particles	■ Aggressive cutting action
■ Variety of tool shapes available as stock	■ Satisfies most tool and die and deburring requirements

For contour grinding applications on carbide, ceramics, glass, ferrites, and many tough alloys and cements. Best suited for blending radii and deburring operations. Operating speeds: 15,000-20,000 RPM range.

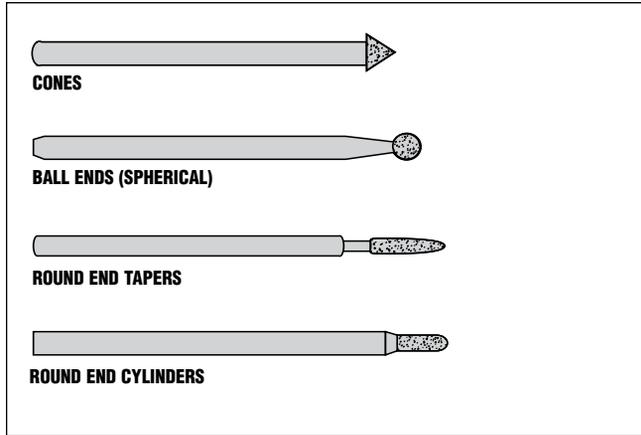

UPC #	PRODUCT #	CONE BASE DIAMETER	INCLUDED ANGLE	CONE LENGTH	GRIT SIZE
<b>CONES – DIAMOND</b>					
<b>1/8" Shank x 2" Overall Length</b>					
66260395484	C14CD	1/8	14°	1/2	100
66260395486 +	C26CD	3/16	26°	13/32	100
66260395488	C35CD	5/32	35°	1/4	100
66260395490	C60CD	11/64	60°	5/32	100
66260395492	C90CD	3/16	90°	3/32	100
<b>CONES – cBN</b>					
<b>1/8" Shank x 2" Overall Length</b>					
66260395483	C14CC	1/8	14°	1/2	100
66260395485	C26CC	3/16	26°	13/32	100
66260395487	C35CC	5/32	35°	1/4	100
66260395489	C60CC	11/64	60°	5/32	100
66260395491	C90CC	3/16	90°	3/32	100

TARGET MARKET SYMBOLS:



UPC #	PRODUCT #	BALL DIAMETER	GRIT SIZE
<b>BALL ENDS (SPHERICAL) – DIAMOND</b>			
<b>1/8" Shank x 2" Overall Length</b>			
66260395434	BE1CD	3/64	100
66260395436	BE2CD	1/16	100
66260395438	BE3CD	5/64	100
66260395440	BE4CD	3/32	100
66260395442	BE5CD	1/8	100
66260395444	BE6CD	3/16	100
66260395446 +	BE7CD	1/4	100
66260395448	BE8CD	3/8	100
66260395450	BE9CD	1/2	100
<b>BALL ENDS (SPHERICAL) – cBN</b>			
<b>1/8" Shank x 2" Overall Length</b>			
66260395433 *	BE1CC	3/64	100
66260395435 *	BE2CC	1/16	100
66260395437	BE3CC	5/64	100
66260395439	BE4CC	3/32	100
66260395441	BE5CC	1/8	100
66260395443	BE6CC	3/16	100
66260395445	BE7CC	1/4	100
66260395447 *	BE8CC	3/8	100
66260395449 *	BE9CC	1/2	100

UPC #	PRODUCT #	SMALL HEAD DIAMETER	LARGE HEAD DIAMETER	HEAD LENGTH	INC. ANGLE	GRIT SIZE
<b>ROUND END TAPERS – DIAMOND</b>						
<b>1/8" Shank x 2" Overall Length</b>						
66260395506	RT44CD	.044	.066	5/16	4°	100
66260395508 *	RT60CD	.060	.082	5/16	4°	100
66260395510	RT78CD	.078	.110	5/16	6°	100
<b>ROUND END TAPERS – cBN</b>						
<b>1/8" Shank x 2" Overall Length</b>						
66260395505 *	RT44CC	.044	.066	5/16	4°	100
66260395507 *	RT60CC	.060	.082	5/16	4°	100
66260395509	RT78CC	.078	.110	5/16	6°	100

UPC #	PRODUCT #	HEAD DIAMETER	HEAD LENGTH	GRIT SIZE
<b>ROUND END CYLINDERS – DIAMOND</b>				
<b>1/8" Shank x 2" Overall Length</b>				
66260395494	RE1CD	1/16	1/4	100
66260395496	RE2CD	5/64	1/4	100
66260395498	RE3CD	3/32	1/4	100
66260395500	RE4CD	1/8	1/4	100
66260395502	RE5CD	3/16	5/16	100
66260395504	RE6CD	1/4	5/16	100
<b>ROUND END CYLINDERS – cBN</b>				
<b>1/8" Shank x 2" Overall Length</b>				
66260395495	RE2CC	5/64	1/4	100
66260395497 *	RE3CC	3/32	1/4	100
66260395499 +	RE4CC	1/8	1/4	100
66260395501 *	RE5CC	3/16	5/16	100
66260395503 *	RE6CC	1/4	5/16	100

+ AVAILABLE AS STOCK WHILE SUPPLIES LAST; THEN AVAILABLE AS NON-STOCK.  
\* NON-STOCK; CONTACT YOUR NORTON REPRESENTATIVE FOR CURRENT LEAD-TIMES.

## ELECTROPLATED GRINDING WHEELS AND FILES

### DIAMOND TYPE 6A2C CUP WHEELS ● ▲

FEATURES	BENEFITS
■ Nickel alloy matrix	■ Tough, durable bond
■ Single layer of abrasive	■ Economical
■ Exposed particles	■ Aggressive cutting action

Extremely fast acting wheels for coarse work (100 grit) and fine finishing (200 grit) of carbide tool bits, etc.

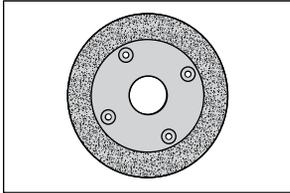

UPC #	PRODUCT #	DIMENSIONS D x T x H	DESCRIPTION	GRIT SIZE
<b>TYPE 6A2C CUP WHEELS WITH MOUNTING HOLES</b>				
<b>Rim 1" – Diamond</b>				
66260300203*	6A2CCD	6 x 7/16 x 1-1/4	6A2C Cup Wheel	100
66260300202*	6A2CFD	6 x 7/16 x 1-1/4	6A2C Cup Wheel	200
66260302135*		6 x 5/16 x 1-1/4	Back-up Plate 6"	

**FOUR 9/32" HOLES ON A 3-1/4" BOLT CIRCLE.**

### DIAMOND TYPE 1A1 BENCH AND PEDESTAL WHEELS ● ▲

FEATURES	BENEFITS
■ Nickel alloy matrix	■ Tough, durable bond
■ Single layer of abrasive	■ Economical
■ Exposed particles	■ Aggressive cutting action
■ Bakelite core	■ Lightweight
	■ Adaptable to standard bench grinders
■ Maintains flat on O.D.	■ Eliminates down time for dressing

Ideal for off-hand grinding. These wheels stay flat without dressing for accurate tool edges. Grind carbide, ceramic and other materials more cost effectively than with conventional silicon carbide abrasive wheels. Available in two grit sizes; 100 grit for roughing and 200 grit for finishing.

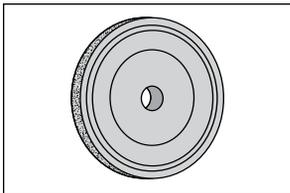

UPC #	PRODUCT #	DIMENSIONS D x T x H	MAX. RPM	GRIT SIZE
<b>TYPE 1A1 BENCH AND PEDESTAL WHEELS – DIAMOND</b>				
66260302087*	A1PG-CD	6 x 1 x 1	7,635	100
66260302086*	A1PG-FD	6 x 1 x 1	7,635	200

**1/2", 5/8", 3/4" AND 7/8" CENTER HOLE REDUCING BUSHINGS ARE INCLUDED.**

TARGET MARKET SYMBOLS:



### DIAMOND MACHINE FILES ● ▲

FEATURES	BENEFITS
■ Nickel alloy matrix	■ Tough, durable bond
■ Single layer of abrasive	■ Economical
■ Exposed particles	■ Aggressive cutting action

For use in reciprocating hand profiling machines. Ideal for reworking and finishing carbide dies and molds, blending radii, and deburring and cleaning slots and grooves.

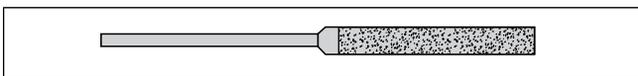

UPC #	PRODUCT #	DIMENSIONS	ABRASIVE LOCATION	GRIT SIZE
<b>MACHINE FILES – DIAMOND (CONT'D)</b>				
<b>5/8" Diamond Length, 1/8" Shank, 2" Overall Length</b>				
66260395589	3FCD	.120 x .040		100
66260395590	4FCD	.157 x .040		100
66260395591	5FCD	.203 x .078		100
66260395592	6FCD	.120 x .040		100
66260395593	1CCD	.098 x .196		100
66260395594	2CCD	.120 x .250		100
66260395596	3TCD	.127 side		100
66260395598	1RCD	.042 diam.		100
66260395599	2RCD	.080 diam.		100
66260395600	3RCD	.127 diam.		100
66260395601	4RCD	.157 diam.		100
66260395602 *	1HRCD	.040 radius		100

**+ AVAILABLE AS STOCK WHILE SUPPLIES LAST; THEN AVAILABLE AS NON-STOCK.  
\* NON-STOCK; CONTACT YOUR NORTON REPRESENTATIVE FOR CURRENT LEAD-TIMES.**

UPC #	PRODUCT #	DIMENSIONS	ABRASIVE LOCATION	GRIT SIZE
<b>MACHINE FILES – DIAMOND</b>				
<b>5/8" Diamond Length, 1/8" Shank, 2" Overall Length</b>				
66260395585	1ECD	.020 x .125		100
66260395586	2ECD	.030 x .125		100
66260395587	3ECD	.040 x .125		100
66260395588 *	2FCD	.079 x .040		100

CONTINUED

## ELECTROPLATED FILES

### DIAMOND HAND FILES ● ▲

FEATURES	BENEFITS
■ Nickel alloy matrix	■ Tough, durable bond
■ Single layer of abrasive	■ Economical
■ Exposed particles	■ Aggressive cutting action

Indispensable aid for the toolroom. All purpose hand-held tool useful for deburring, notching, dressing, and honing hard, brittle materials.



UPC #	PRODUCT #	DIMENSIONS	ABRASIVE LOCATION	GRIT SIZE
<b>HAND FILES – DIAMOND</b>				
<b>6" Overall Length, 1-1/2" Diamond Length</b>				
66260395605	DF1CD	1/8 x 1/8		100
66260392842 +	DF1FD	1/8 x 1/8		200
66260395606	DF2CD	1/8 x 1/4		100

CONTINUED

UPC #	PRODUCT #	DIMENSIONS	ABRASIVE LOCATION	GRIT SIZE
<b>HAND FILES – DIAMOND (CONT'D)</b>				
<b>6" Overall Length, 1-1/2" Diamond Length</b>				
66260392843	DF2FD	1/8 x 1/4		200
66260395607	DF2WCD	1/8 x 1/4		100
66260395608	DF3CD	1/8 x 3/8		100
66260392844	DF3FD	1/8 x 3/8		200
66260395609	DF3WCD	1/8 x 3/8		100
66260364241	DF3SCD	1/8 x 1/2		100
66260395611	DF4CD	1/8		100
66260392845 *	DF4FD	1/8		200
66260300134	DF4WCD	1/4		100
66260395613	DF5CD	1/8		100
66260392846	DF5FD	1/8		200
66260395614	DF5WCD	1/4		100
66260395615	DF6CD	1/8		100
66260392847 *	DF6FD	1/8		200

### DIAMOND NEEDLE FILES ● ▲

FEATURES	BENEFITS
■ Nickel alloy matrix	■ Tough, durable bond
■ Single layer of abrasive	■ Economical
■ Exposed particles	■ Aggressive cutting action

Indispensable aid for the toolroom. An all purpose hand-held tool, useful for deburring, notching, dressing, and honing hard, brittle materials.

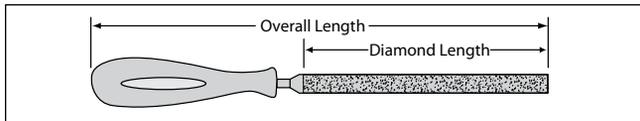

UPC #	PRODUCT #	DIMENSIONS	ABRASIVE LOCATION	SHAPE	GRIT SIZE
<b>NEEDLE FILES – DIAMOND</b>					
<b>4-1/4" Diamond Length, 8-1/2" Overall Length</b>					
66260302432	LNF2CD	.400 x .100		Equaling	100
66260305611	LNF2FD	.400 x .100		Equaling	200
66260302898	LNF3CD	.45 x .150		Half Round	100
66260305612	LNF3FD	.485 x .150		Half Round	200
<b>2-3/4" Diamond Length, 5-3/4" Overall Length, With Handle</b>					
66260391729	1571	.055 x .190		Flat	100
66260391730	1572	.075 x .210		Half Round	100
66260391731	1573	.145 x .145		Triangle	100
66260391732	1574	.100 x .100		Square	100
66260391733	1575	.120		Round	100
66260391734	1576	.055 x .190		Pointed Flat	100
<b>3" Diamond Length, 5-1/2" Overall Length, With Handle</b>					
66260395575	NF1FD	.150 x .105		Oval	200
66260395576	NF2FD	.218 x .072		Half Round	200
66260395577	NF3FD	.205 x .058		Equaling	200
66260395578	NF4FD	.096 x .096		Square	200

CONTINUED

UPC #	PRODUCT #	DIMENSIONS	ABRASIVE LOCATION	SHAPE	GRIT SIZE
<b>NEEDLE FILES – DIAMOND (CONT'D)</b>					
<b>3" Diamond Length, 5-1/2" Overall Length, With Handle</b>					
66260395579	NF5FD	.138 x .138		Triangle	200
66260395580	NF6FD	.118		Round	200
66260395581+	NF7FD	.197 x .088		Crossing	200
66260395582+	NF8FD	.205 x .067		Barrette	200

UPC #	PRODUCT #	GRIT SIZE
<b>NFK-6 NEEDLE FILE KIT – DIAMOND</b>		
66260364008	NFK-6	contains one each of the following:
	NF1FD	200
	NF2FD	200
	NF3FD	200
	NF4FD	200
	NF5FD	200
	NF6FD	200

UPC #	PRODUCT #	GRIT SIZE
<b>DFS-6 DIE FILE KIT – DIAMOND</b>		
66260391830	DFS-6	contains one each of the following:
	1571	100
	1572	100
	1573	100
	1574	100
	1575	100
	1576	100

#### NEEDLE FILE SHAPE AND APPLICATION KEY:

- Barrette:** A triangle with diamond on the bottom side only
- Crossing:** Elongated oval, with more pointed ends than an oval file; has diamonds all around
- Equaling:** A rectangle with diamond on all four sides; ideal for filing both sides of an ID simultaneously
- Pointed Flat:** A cone with a flat top with diamond on the sides of the cone

TARGET MARKET SYMBOLS:



+ AVAILABLE AS STOCK WHILE SUPPLIES LAST; THEN AVAILABLE AS NON-STOCK.  
\* NON-STOCK; CONTACT YOUR NORTON REPRESENTATIVE FOR CURRENT LEAD-TIMES.

## ELECTROPLATED DRILLS

### DIAMOND CORE DRILLS ● ■

FEATURES	BENEFITS
■ Nickel alloy matrix	■ Tough, durable bond
■ Single layer of abrasive	■ Economical
■ Exposed particles	■ Aggressive cutting action

High performance on glass and ceramic applications while providing fast, reliable cutting. Submersed drilling is highly recommended for optimum operating performance.



UPC #	PRODUCT #	OUTER DIAMETER	INNER DIAMETER	GRIT SIZE
<b>CORE DRILLS – DIAMOND</b>				
<b>Straight Tube Type, 2" Overall Length</b>				
66260395530	A1MD	1/16	.023	150
66260395531	A2MD	3/32	.048	150
66260395532	A3MD	1/8	.075	150
66260395533	A4MD	5/32	.110	150
66260395534	A5CD	3/16	.140	100
66260395535	A6CD	1/4	.195	100
66260395536	A7CD	5/16	.255	100
66260395537	A8CD	3/8	.325	100
66260395538 *	A9CD	7/16	.373	80
66260395539 +	A10CD	1/2	.398	80

### DIAMOND MOUNTED CORE DRILLS ● ■

FEATURES	BENEFITS
■ Nickel alloy matrix	■ Tough, durable bond
■ Single layer of abrasive	■ Economical
■ Exposed particles	■ Aggressive cutting action
■ Removable pilot (bulb-like extension)	■ Provides added stability
	■ Ensures smooth drilling with less wobbling
■ 1/8" wrap: additional 1/8" of electroplated diamond on the blade core	■ Increases life of blade on deep cuts, reduces binding and grinding on the core

High performance results on glass and ceramic applications.

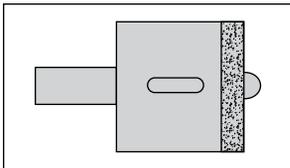

UPC #	PRODUCT #	OUTER DIAMETER	PILOT DIAMETER	GRIT SIZE
<b>MOUNTED CORE DRILLS – DIAMOND</b>				
<b>1/8" Wrap, 3/8" Shank Diameter, 3.45" Overall Length</b>				
66260392850	CD.750	3/4	1/4	40
66260392854 *	CD2.000	2	1/4	40

**PILOTS ARE REMOVABLE.**

### DIAMOND TWIST DRILLS ● ■

FEATURES	BENEFITS
■ Nickel alloy matrix	■ Tough, durable bond
■ Single layer of abrasive	■ Economical
■ Exposed particles	■ Aggressive cutting action

Recommended for precision drilling on circuit boards containing fiberglass, nylon, and similar tough, abrasive materials. Diamond twist drills are also useful for drilling plastics and resin composites and have been successful in drilling soft ductile materials as well as "green" carbide. Operating procedures are similar to those of standard twist drills.

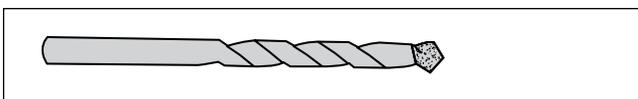

UPC #	PRODUCT #	DRILL DIAMETER	DRILL LENGTH	GRIT SIZE
<b>TWIST DRILLS – DIAMOND</b>				
66260395549	TW-1/16	1/16	1-3/4	100
66260395550	TW-1/8	1/8	2-3/4	100
66260395551	TW-1/4	1/4	4	100
66260395552	TW-3/8	3/8	5	100

**DIAMETER TOLERANCE EQUALS + OR - 1/64.**

+ AVAILABLE AS STOCK WHILE SUPPLIES LAST; THEN AVAILABLE AS NON-STOCK.  
\* NON-STOCK; CONTACT YOUR NORTON REPRESENTATIVE FOR CURRENT LEAD-TIMES.

TARGET MARKET SYMBOLS:



**ELECTROPLATED SAW BLADES**

**DIAMOND CONTINUOUS RIM CUT-OFF SAW BLADES ■**

FEATURES	BENEFITS
■ Nickel alloy matrix	■ Tough, durable bond
■ Single layer of abrasive	■ Economical
■ Exposed particles	■ Aggressive cutting action

Ideal for cutting-off highly-abrasive materials such as alumina, fiberglass, plastics, and other nonmetallic composite materials.

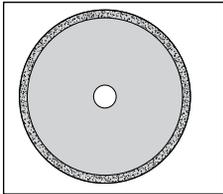

Additional Diamond Slotted and Continuous Rim Cut-off Saw Blades, with extended wraps to avoid binding, are available as made-to-order products. Please contact your Norton representative.

UPC #	PRODUCT #	DIAM.	OVERALL THICKNESS	HOLE SIZE	GRIT SIZE
<b>CONTINUOUS RIM CUT-OFF SAW BLADES – DIAMOND</b>					
66260301990	DS2062-250	2	1/16	1/4	40
66260391474	DS2094-250	2	3/32	1/4	40
66260391473	DS3094-250	3	3/32	1/4	40
66260363036	DS3094-375	3	3/32	3/8	40
66260395554	DS4094-500	4	3/32	1/2	40
66260300197	DS4094-750	4	3/32	3/4	40
66260312207 *	DS5094-500	5	3/32	1/2	40
66260395555 *	DS6094-500	6	3/32	1/2	40
66260395556 *	DS7062-500	7	1/16	1/2	40
66260395557	DS8094-625	8	3/32	5/8	40
66260391464 *	DS10125-625	10	1/8	5/8	40

**DIAMOND SLOTTED CUT-OFF SAW BLADES ■**

FEATURES	BENEFITS
■ Nickel alloy matrix	■ Tough, durable bond
■ Single layer of abrasive	■ Economical
■ Exposed particles	■ Aggressive cutting action
■ 3/4" wrap: additional 3/4" of electroplated diamond on the blade core	■ Increases life of blade on deep cuts, reduces binding and grinding on the core

Ideal for cutting-off highly abrasive materials such as alumina, fiberglass, plastics, and other nonmetallic composite materials.

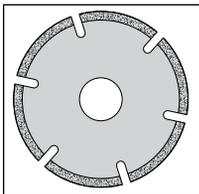

UPC #	PRODUCT #	DIAM.	OVERALL THICKNESS	HOLE SIZE	GRIT SIZE
<b>SLOTTED CUT-OFF SAW BLADES – DIAMOND</b>					
66260301989	DSS2062-250	2	1/16	1/4	40
66260364258	DSS3094-250	3	3/32	1/4	40
66260363015	DSS4094-375	4	3/32	3/8	40
66260395559	DSS4094-500	4	3/32	1/2	40
66260300360 +	DSS4094-750	4	3/32	3/4	40
66260395560	DSS6094-500	6	3/32	1/2	40
66260395561 *	DSS8094-500	8	3/32	1/2	40
66260362981	DSS10125-625	10	1/8	5/8	40
66260395563	DSS12125-500	12	1/8	1/2	40
66260362985 *	DSS12125-1	12	1/8	1	40
66260364253	DSS14156-500	14	5/32	1/2	40
66260362989	DSS14156-1	14	5/32	1	40
66260395565	DSS16156-1	16	5/32	1	40
66260395566	DSS18156-1	18	5/32	1	40
66260395567 *	DSS20156-1	20	5/32	1	40
<b>SLOTTED CUT-OFF SAW BLADES WITH 3/4" WRAP – DIAMOND</b>					
66260313422 *	DSSW4094-500	4	3/32	1/2	40
66260313423	DSSW4094-750	4	3/32	3/4	40
66260313433 *	DSSW5094-750	5	3/32	3/4	40

**DIAMOND MOUNTED SAW BLADES ■**

FEATURES	BENEFITS
■ Nickel alloy matrix	■ Tough, durable bond
■ Single layer of abrasive	■ Economical
■ Exposed particles	■ Aggressive cutting action

Ideal for cutting off highly abrasive materials such as alumina, fiberglass, plastics, and other nonmetallic composite materials.

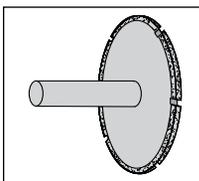

UPC #	PRODUCT #	DIAM.	OVERALL THICKNESS	HOLE SIZE	GRIT SIZE
<b>MOUNTED SAW BLADES – DIAMOND</b>					
<b>2" Overall Length</b>					
66260395422	MDS1CD	1	3/32	1/4	40
66260395423	MDS1-1/2CD	1-1/2	3/32	1/4	40
66260395424	MDS2CD	2	3/32	3/8	40

TARGET MARKET SYMBOLS: ● CERAMICS ▲ TOOL & DIE ■ COMPOSITES

+ AVAILABLE AS STOCK WHILE SUPPLIES LAST; THEN AVAILABLE AS NON-STOCK.  
\* NON-STOCK; CONTACT YOUR NORTON REPRESENTATIVE FOR CURRENT LEAD-TIMES.



## NORTON DIAMOND LAPPING COMPOUND

### DIAMOND LAPPING COMPOUND ● ▲

FEATURES	BENEFITS
■ Diamond powders uniformly distributed in a liquid vehicle	■ Aggressive polishing
■ Easy to use plastic syringe	■ Consistent part quality
	■ Quick clean-up

Performs on all materials – hard and soft. Excellent for mold, die and tool polishing, polishing to final tolerance of ceramic parts, initial charging of lapping plates and discs, and other processes that require mirror finish and close tolerance performance. Use oil soluble when solvent is used for clean-up, and water soluble when soap/water is used for clean-up.



PRODUCT #	MICRON GRADE	COLOR	UPC #
<b>DIAMOND COMPOUND – WATER SOLUBLE</b>			
<b>5 Gram Syringes</b>			
5PS1/4WSSTD	1/4 Ultra Fine	Gray	66260300362
5PS1/2WSSTD	1/2 Ultra Fine	Lt. Gray	66260300417
5PS1WSSTD	1 Ultra Fine	Ivory	66260300368
5PS3WSSTD	3 Super Fine	Yellow	66260300667
5PS6WSSTD	6 Super Fine	Orange	66260300372
5PS9WSSTD	9 Super Fine	Green	66260300375
5PS12WSSTD	12 Super Fine	Aqua	66260300376
5PS15WSSTD	15 Fine	Blue	66260300379
5PS20WSSTD	20 Fine	Auburn	66260300381 *
5PS30WSSTD	30 Fine	Red	66260300383
5PS45WSSTD	45 Fine	Brown	66260300384
5PS60WSSTD	60 Fine	Purple	66260300388
5PS90WSSTD	90 Fine	Black	66260300389
<b>18 Gram Syringes</b>			
18PS1/4WSSTD	1/4 Ultra Fine	Gray	66260300392
18PS1/2WSSTD	1/2 Ultra Fine	Lt. Gray	66260300394
18PS1WSSTD	1 Ultra Fine	Ivory	66260300396
18PS3WSSTD	3 Super Fine	Yellow	66260300398
18PS6WSSTD	6 Super Fine	Orange	66260300400
18PS9WSSTD	9 Super Fine	Green	66260300402
18PS12WSSTD	12 Super Fine	Aqua	66260300404 *
18PS15WSSTD	15 Fine	Blue	66260300406
18PS20WSSTD	20 Fine	Auburn	66260300408
18PS30WSSTD	30 Fine	Red	66260300410 *
18PS45WSSTD	45 Fine	Brown	66260300412 *
18PS60WSSTD	60 Fine	Purple	66260300414 *
18PS90WSSTD	90 Fine	Black	66260300416 *
Polishing Kit	Kit Includes: four 5 gram syringes of diamond paste: 3u, 6u, 15u, 30u; 4 pieces of substrate; 1 bottle of lubricant		07660702462 *

+ AVAILABLE AS STOCK WHILE SUPPLIES LAST; THEN AVAILABLE AS NON-STOCK.  
\* NON-STOCK; CONTACT YOUR NORTON REPRESENTATIVE FOR CURRENT LEAD-TIMES.

PRODUCT #	MICRON GRADE	COLOR	UPC #
<b>DIAMOND COMPOUND – OIL SOLUBLE</b>			
<b>5 Gram Syringes</b>			
5PS1/4OSSTD	1/4 UltraFine	Gray	61463691123 *
5PS1/2OSSTD	1/2 UltraFine	Lt. Gray	66260300363
5PS1OSSTD	1 UltraFine	Ivory	61463691133
5PS3OSSTD	3 Super Fine	Yellow	61463691138
5PS6OSSTD	6 Super Fine	Orange	61463691143
5PS9OSSTD	9 Super Fine	Green	61463691148
5PS12OSSTD	12 Super Fine	Aqua	66260300377 *
5PS15OSSTD	15 Fine	Blue	61463691153
5PS20OSSTD	20 Fine	Auburn	66260300380 *
5PS30OSSTD	30 Fine	Red	61463691158
5PS45OSSTD	45 Fine	Brown	61463691163
5PS60OSSTD	60 Fine	Purple	66260300386
5PS90OSSTD	90 Fine	Black	66260300390
<b>18 Gram Syringes</b>			
18PS1/4OSSTD	1/4 UltraFine	Gray	66260300391
18PS1/2OSSTD	1/2 UltraFine	Lt. Gray	66260300393 *
18PS1OSSTD	1 UltraFine	Ivory	61463691134 *
18PS3OSSTD	3 Super Fine	Yellow	61463691139
18PS6OSSTD	6 Super Fine	Orange	66260300399
18PS9OSSTD	9 Super Fine	Green	61463691149 *
18PS12OSSTD	12 Super Fine	Aqua	66260300403 *
18PS15OSSTD	15 Fine	Blue	61463691154
18PS20OSSTD	20 Fine	Auburn	66260300407
18PS30OSSTD	30 Fine	Red	66260300409
18PS45OSSTD	45 Fine	Brown	61463691164 *
18PS60OSSTD	60 Fine	Purple	66260300413
18PS90OSSTD	90 Fine	Black	66260300415

TARGET MARKET SYMBOLS: ● ▲ ■  
CERAMICS TOOL & DIE COMPOSITES

## SPECcheck

### DIAMOND COMPOUND APPLICATION GUIDE

APPLICATION	MICRON GRADE	MICRON RANGE	MESH SIZE EQUIVALENT	COLOR	CONC.
<b>ULTRA FINE</b>	1/4	(0-1/2)	100,000	Gray	Std.
Applying finest finishes on metals and ceramics	1/2	(0-1)	60,000	Lt. Gray	Std.
	1	(0-2)	14,000	Ivory	Std.
<b>SUPER FINE</b>	3	(2-4)	8,000	Yellow	Std.
Final finishing for dies, molds, seals, most applications (RMS 4-12)	6	(4-8)	3,000	Orange	Std.
	9	(8-12)	1,800	Green	Std.
	12	(9-15)	1,500	Aqua	Std.
<b>FINE FINISH</b>	15	(12-22)	1,200	Blue	Std.
Preparatory lapping (RMS 12-20)	20	(15-25)	800	Auburn	Std.
	30	(22-36)	600	Red	Std.
	45	(36-45)	325	Brown	Std.
	60	(54-80)	230	Purple	Std.
	90	(80-100)	170	Black	Std.

### MARKING SYSTEM

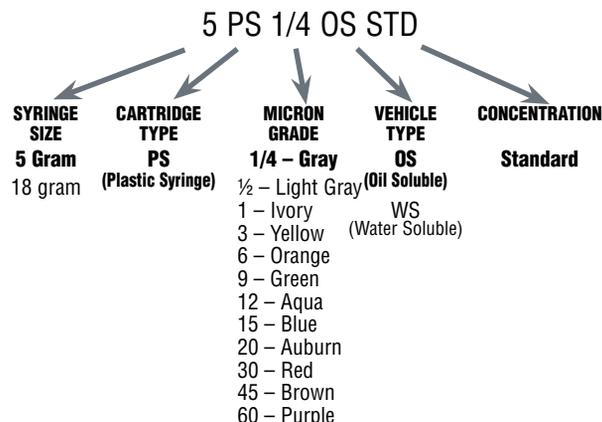

# TECHtip

## AVOID GRINDING STEEL

- Avoid steel when grinding with diamond wheels. Keep the amount of steel ground to an absolute minimum.
- On brazed tools, use aluminum oxide wheel to back off the steel shank.
- A high lubricity grinding fluid should be used.
- For some steels, an armored (AMD) diamond wheel may prove most economical.

## USE RIGID WORK SUPPORT

- All workpieces should be supported firmly during the grinding process. Any amount of vibration will cause wheel wear and produce chatter or wave marks on the ground surface.
- On work ground between centers, centerholds should be properly prepared.
- Minimize work overhang.
- If the ground work is supported by a work finger, ensure the finger is strong enough to provide vibration-free support.

## COOLANT – GRIND WET

- Diamond wheels should be used with a full flood coolant properly directed toward the grinding zone. Water with a rust inhibitor is recommended.
- Vitrified diamond wheels should be used only with a coolant.
- When flood application can't be used, try mist or spray application.
  - Use compressed air to "atomize" water or soluble oil.
  - Direct the spray at the grinding zone to help dissipate heat and prevent heat damage to the work.

## AVOID EXCESSIVE FEEDS

- Excessive feeds will result in premature wheel wear. Excessive feed rates are characterized by:
  - A hard grinding sound
  - Chatter
  - Burn
  - High wheel wear rate
  - Vibration

# SPECcheck

## TROUBLESHOOTING GUIDE – DRY GRINDING

PROBLEM	POSSIBLE CAUSES	SUGGESTED CORRECTION
Burning (excessive heat)	Wheel loaded or glazed Excessive feed rate Wheel too durable	Dress wheel with a dressing stick Reduce infeed of wheel or workpiece Use freer cutting specification or slow down wheel speed
Poor finish	Grit size too coarse Excessive feed rate	Select a finer grit size Reduce infeed of wheel or workpiece
Chatter	Wheel out of truth	True wheel; ensure it is not slipping on mount (See "Mounting, Truing and Dressing Guide")

## TROUBLESHOOTING GUIDE – WET GRINDING

PROBLEM	POSSIBLE CAUSES	SUGGESTED CORRECTION
Burning (excessive heat)	Wheel glazed or loaded Poor coolant placement Excessive material removal rate	Re-dress wheel Apply coolant directly to wheel/workpiece interface Reduce downfeed and/or crossfeed
Poor finish	Excessive dressing Grit size too coarse Poor coolant flow or location	Use lighter dressing pressure Stop dressing as soon as wheel starts to consume stick rapidly Select a finer grit size Apply heavy flood so it reaches wheel/work interface
Chatter	Wheel out of truth	True wheel; ensure it is not slipping on mount
Wheel will not cut	Glazed by truing Wheel loaded	Dress lightly until wheel opens up Dress lightly until wheel opens up Increase coolant flow to keep wheel surface clean Never run wheel with coolant turned off
Slow cutting	Low feeds and speeds	Increase feed rate; increase wheel speed (Do not exceed wheel MOS)
Short wheel life	Incorrect coolant flow Low wheel speed Excessive dressing Wheel too soft or too hard	Apply coolant to flood wheel/work surface Increase wheel speed (observe maximum operating speed) Use lighter dressing pressure Change grit or grade; use higher concentration

## MATERIAL HARDNESS SCALE

Superabrasives is a term used to describe those abrasives of extreme hardness which produce outstanding results when properly used on specific applications. The following chart provides a hardness comparison (Knoop Hardness Scale) between diamond and cBN superabrasives, aluminum oxide and silicon carbide standard abrasives, and some common materials these abrasives are used to grind.

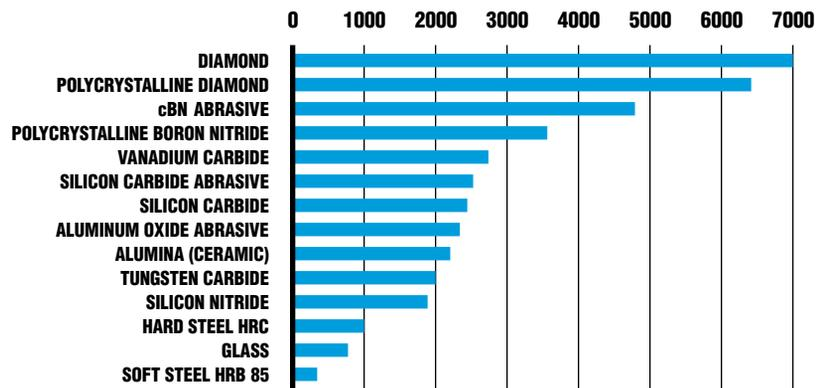

**DECIMAL AND METRIC EQUIVALENTS OF COMMON FRACTIONS**

FRACTIONS OF AN INCH	DECIMALS OF AN INCH	MILLIMETERS
1/64	.0156	0.397
1/32	.0313	0.794
3/64	.0469	1.191
1/16	.0625	1.588
5/64	.0781	1.985
3/32	.0938	2.381
7/64	.1094	2.778
1/8	.1250	3.175
9/64	.1406	3.572
5/32	.1563	3.969
11/64	.1719	4.366
3/16	.1875	4.762
13/64	.2031	5.159
7/32	.2188	5.556
15/64	.2344	5.953
1/4	.2500	6.350
17/64	.2656	6.747
9/32	.2813	7.144
19/64	.2969	7.541
5/16	.3135	7.937
21/64	.3281	8.334
11/32	.3438	8.731
23/64	.3594	9.128
3/8	.3750	9.525
25/64	.3906	9.922
13/32	.4063	10.319
27/64	.4219	10.716
7/16	.4375	11.112
29/64	.4531	11.509
15/32	.4688	11.906
31/64	.4844	12.303
1/2	.5000	12.700
33/64	.5156	13.097
17/32	.5313	13.494
35/64	.5469	13.891
9/16	.5625	14.287
37/64	.5781	14.684
19/32	.5938	15.081
39/64	.6094	15.478
5/8	.6250	15.875
41/64	.6406	16.272
21/32	.6563	16.688
43/64	.6719	17.085
11/16	.6875	17.462
45/64	.7031	17.859
23/32	.7188	18.256
47/64	.7344	18.653
3/4	.7500	19.050
49/64	.7645	19.447
25/32	.7813	19.843
51/64	.7969	20.240
13/16	.8125	20.637
53/64	.8281	21.034
27/32	.8438	21.430
55/64	.8594	21.827
7/8	.8750	22.224
57/64	.8906	22.621
29/32	.9063	23.018
59/64	.9219	23.415
15/16	.9375	23.812
61/64	.9531	24.209
31/32	.9688	24.606
63/64	.9844	25.003
1	1.0000	25.400

**EXPECTED SURFACE FINISH BY GRIT SIZE FOR RESIN BOND**

Use these charts as guides only. Surface finish is affected by several variables: machine type and condition, type of material ground, coolant, wheel speed, bond system, etc.

**Diamond**

GRIT SIZE	EXPECTED FINISH MICRO INCH AA	MAXIMUM DEPTH OF CUT PER PASS FOR GRIT SIZE
T00	24 to 32	0.001" to 0.002"
120	16 to 18	0.001" to 0.002"
150	14 to 16	0.001" to 0.002"
180	12 to 14	0.0007" to 0.001"
220	10 to 12	0.0007" to 0.001"
320	8	0.0004" to 0.0006"
400	7 to 8	0.0003" to 0.0005"

**cBN**

GRIT SIZE	EXPECTED FINISH WITH OSCILLATION	EXPECTED FINISH PLUNGE
T00	35 – 40	40 – 45
120	30 – 35	35 – 40
150	25 – 30	30 – 35
180	20 – 25	25 – 30
220	15 – 20	20 – 25
320	10 – 15	15 – 20
400	4 – 8	5 – 10

REFER TO ELECTROPLATED GENERAL INFORMATION FOR FINISHES BY GRIT SIZE FOR ELECTROPLATED WHEELS.

**RECOMMENDED WHEEL SPEEDS FOR DIAMOND AND cBN WHEELS**

**WET GRINDING**

	CUP WHEELS	PERIPHERAL WHEELS
<b>DIAMOND GRINDING WHEELS</b>		
	<b>11V9, 12V9, 15V9, etc.</b>	<b>1A1, 1V1, 1A1R, etc.</b>
<b>Resin Bond Wheels</b>	4921 to 7874 SFPM 25 to 40 m/s	4921 to 7874 SFPM 25 to 40 m/s
<b>Metal Bond Wheels</b>		3937 to 5906 SFPM 20 to 30 m/s
<b>Vitrified Bond Wheels</b>	2953 to 5906 SFPM 15 to 30 m/s	2953 to 5906 SFPM 15 to 30 m/s

**cBN GRINDING WHEELS**

<b>Resin Bond Wheels</b>	5906 to 9843 SFPM 30 to 50 m/s	5906 to 9843 SFPM 30 to 50 m/s
--------------------------	-----------------------------------	-----------------------------------

**DRY GRINDING**

	CUP WHEELS	PERIPHERAL WHEELS
<b>DIAMOND GRINDING WHEELS</b>		
	<b>11V9, 12V9, 15V9, etc.</b>	<b>1A1, 1V1, 1A1R, etc.</b>
<b>Resin Bond Wheels</b>	2756 to 3543 SFPM 14 to 18 m/s	2756 to 3543 SFPM 14 to 18 m/s
<b>cBN GRINDING WHEELS</b>		
<b>Resin Bond Wheels</b>	2953 to 5906 SFPM 15 to 30 m/s	2953 to 5906 SFPM 15 to 30 m/s

**NOTE: THESE ARE NOT THE MAXIMUM OPERATING SPEEDS (MOS). CONSULT ANSI B7.1 OR CONTACT YOUR NORTON REPRESENTATIVE FOR MOS.**

**WHEEL SPEED CALCULATION:**

To convert m/s to SFPM:	<b>Multiply M/S x 196.85 = SFPM</b>
To convert SFPM to M/S:	<b>Divide SFPM by 196.85 = M/S</b>
To convert RPM to SFPM:	<b>Multiply wheel diameter in inches x RPM x 0.262</b>

M/S = METERS/SECOND RPM = REVOLUTIONS PER MINUTE SFPM = SURFACE FEET PER MINUTE

**CONVERSION TABLE – WHEEL SPEEDS**

**Revolutions Per Minute for various diameters of grinding wheels – to give Surface Speed in Feet Per Minute as indicated**

(for wheel marking purposes the calculated RPM figures listed below are rounded off to the next 5)

DIAMETER OF WHEEL IN INCHES	SURFACE SPEED IN FEET PER MINUTE (SFPFM)																				
	4,000	4,500	5,000	5,500	6,000	6,500	7,000	7,500	8,000	8,500	9,000	9,500	10,000	12,000	12,500	14,200	16,000	16,500	17,000	19,685	20,000
1	15,279	17,189	19,098	21,008	22,918	24,828	26,737	28,647	30,558	32,467	34,377	36,287	38,196	45,836	47,745	54,240	61,116	63,025	64,935	75,190	76,395
2	7,639	8,594	9,549	10,504	11,459	12,414	13,368	14,328	15,278	16,238	17,188	18,143	19,098	22,918	23,875	27,120	30,558	31,510	32,465	37,595	38,195
3	5,093	5,729	6,366	7,003	7,639	8,276	8,913	9,549	10,186	10,822	11,459	12,096	12,732	15,278	15,915	18,080	20,372	21,010	21,645	25,065	25,465
4	3,820	4,297	4,775	5,252	5,729	6,207	6,685	7,162	7,640	8,116	8,595	9,072	9,549	11,459	11,940	13,560	15,278	15,755	16,235	18,800	19,100
5	3,056	3,438	3,820	4,202	4,584	4,966	5,348	5,730	6,112	6,494	6,876	7,258	7,640	9,168	9,550	10,850	12,224	12,605	12,985	15,040	15,280
6	2,546	2,865	3,183	3,501	3,820	4,138	4,456	4,775	5,092	5,411	5,729	6,048	6,366	7,639	7,960	9,040	10,186	10,505	10,820	12,530	12,730
7	2,183	2,455	2,728	3,001	3,274	3,547	3,820	4,092	4,366	4,638	4,911	5,183	5,456	6,548	6,820	7,750	8,732	9,005	9,275	10,740	10,915
8	1,910	2,148	2,387	2,626	2,865	3,103	3,342	3,580	3,820	4,058	4,297	4,535	4,775	5,729	5,970	6,780	7,640	7,880	8,115	9,400	9,550
9	1,698	1,910	2,122	2,334	2,546	2,758	2,970	3,182	3,396	3,606	3,820	4,032	4,244	5,092	5,305	6,030	6,792	7,000	7,215	8,355	8,490
10	1,528	1,719	1,910	2,101	2,292	2,483	2,674	2,865	3,056	3,247	3,438	3,629	3,820	4,584	4,775	5,425	6,112	6,300	6,495	7,520	7,640
12	1,273	1,432	1,591	1,751	1,910	2,069	2,228	2,386	2,546	2,705	2,864	3,023	3,183	3,820	3,980	4,520	5,092	5,250	5,410	6,265	6,365
14	1,091	1,228	1,364	1,500	1,637	1,773	1,910	2,046	2,182	2,319	2,455	2,592	2,728	3,274	3,410	3,875	4,366	4,500	4,640	5,370	5,455
16	955	1,074	1,194	1,313	1,432	1,552	1,672	1,791	1,910	2,029	2,149	2,268	2,387	2,865	2,985	3,390	3,820	3,940	4,060	4,700	4,775
18	849	955	1,061	1,167	1,273	1,379	1,485	1,591	1,698	1,803	1,910	2,016	2,122	2,546	2,655	3,015	3,396	3,500	3,605	4,175	4,245
20	764	859	955	1,050	1,146	1,241	1,337	1,432	1,528	1,623	1,719	1,814	1,910	2,292	2,390	2,715	3,056	3,150	3,245	3,760	3,820
22	694	781	868	955	1,042	1,128	1,215	1,302	1,388	1,476	1,562	1,649	1,736	2,084	2,170	2,465	2,776	2,865	2,950	3,420	3,470
24	637	716	796	875	955	1,034	1,115	1,194	1,274	1,353	1,433	1,512	1,591	1,910	1,990	2,260	2,546	2,625	2,705	3,135	3,185
26	588	661	734	808	881	955	1,028	1,101	1,176	1,248	1,322	1,395	1,468	1,762	1,840	2,090	2,352	2,425	2,495	2,890	2,940
28	546	614	682	750	818	887	955	1,023	1,092	1,159	1,228	1,296	1,364	1,637	1,705	1,940	2,182	2,250	2,320	2,685	2,730
30	509	573	637	700	764	828	891	955	1,018	1,082	1,146	1,210	1,274	1,528	1,595	1,810	2,056	2,100	2,165	2,505	2,545
32	477	537	597	656	716	776	836	895	954	1,014	1,074	1,134	1,194	1,432	1,495	1,695	1,910	1,970	2,030	2,350	2,385
34	449	505	562	618	674	730	786	843	898	955	1,011	1,067	1,124	1,348	1,405	1,595	1,796	1,855	1,910	2,210	2,245
36	424	477	530	583	637	690	742	795	848	902	954	1,007	1,061	1,273	1,330	1,510	1,698	1,750	1,805	2,090	2,120
38	402	452	503	553	603	653	704	754	804	854	904	955	1,006	1,206	1,260	1,430	1,608	1,660	1,710	1,980	2,010
40	382	430	478	525	573	620	669	716	764	812	860	908	956	1,146	1,195	1,355	1,528	1,575	1,625	1,880	1,910
42	366	409	454	500	545	591	636	682	732	775	818	863	908	1,090	1,140	1,295	1,464	1,500	1,545	1,790	1,820
44	347	390	434	478	521	564	608	651	694	737	780	824	868	1,042	1,085	1,235	1,388	1,432	1,475	1,710	1,735
46	333	375	416	458	500	541	582	624	666	708	750	791	832	1,000	1,040	1,180	1,332	1,370	1,410	1,635	1,660
48	318	358	398	438	478	517	558	597	636	676	716	756	796	956	995	1,130	1,272	1,315	1,350	1,565	1,590
53	288	324	360	395	432	468	503	539	576	612	648	683	720	864	900	1,025	1,152	1,189	1,225	1,420	1,440
60	255	287	319	350	387	414	446	478	510	542	574	606	638	774	795	905	1,020	1,050	1,080	1,255	1,275
72	212	239	265	291	318	345	371	398	424	451	477	504	530	637	665	849	875	905	955	1,045	1,060

FOR INTERMEDIATE DIAMETERS NOT LISTED USE THE FORMULA LISTED IN SECTION 1.2.10 OF ANSI B7.1 (SFPFM = 262 X WHEEL DIAMETER IN INCHES X RPM.)  
TO CONVERT METERS PER SECOND (M/S) TO SFPFM: M/S X 196.85 = SFPFM. TO CONVERT SFPFM TO M/S: SFPFM/196.85 = M/S. TO CONVERT RPM TO SFPFM: WHEEL DIAMETER IN INCHES X RPM X 0.262 = SFPFM

## FOR YOUR PROTECTION

**Safety Gloves**

Grinding applications are conducted in harsh environments. The use of proper fitting gloves is recommended.

**Face and Eye Protection**

Always wear government-approved face and eye protection when using abrasive products.

**Speeds**

Check machine spindle speed and speed listed on machine against safe maximum operating speed marked on the grinding wheel. Do not overspeed the wheel.

**Hearing Protection**

Use of abrasive products may create elevated sound levels. Hearing protection must be worn where required.

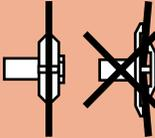
**Flanges**

When mounting most grinding wheels, use flanges of equal diameter and bearing surface. For exceptions, see ANSI B7.1.

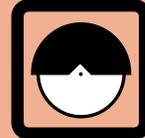
**Wheel Guard**

Always use the wheel guard as supplied by the machine manufacturer, in the proper position.

**Safety Guides, MSDS and Wheel Warning Messages**

Before using any abrasive materials, READ:

- The Safety Guides
- Wheel Warning Messages and
- Material Safety Data Sheets (MSDS)

Norton provides information pertaining to the safe use of all products. Please take the time to read it carefully. Contact suppliers of the workpiece and abrasive materials for copies of the MSDS if one is not readily available. Norton abrasives MSDS can be obtained on [www.nortonabrasives.com](http://www.nortonabrasives.com)

**Dust Protection**

Exposure to dust generated from workpiece and/or abrasive materials can result in lung damage and/or other physical injury.

Use dust capture or local exhaust as stated in the MSDS. Wear government-approved respiratory protection and eye and skin protection.

Failure to follow this warning can result in serious lung damage and/or physical injury.

This is a general dust warning and does not cover specific situations. For more information, refer to the MSDS dust warning provided with your products, and workpiece.

**Blotter**

Use paper or plastic blotters only when mounting superabrasive wheels with vitrified cores. Using paper or plastic blotters on any other core material may result in the wheel loosening during grinding.

**Warning**

This warning icon appears on our products and packaging. It is intended to draw your attention to the specific safety warning practices outlined after it.

## SAFE OPERATING PRACTICES

Safe operating practices must be part of every grinding wheel user's operation. The greatest efficiency and lowest overall abrasive cost can be realized only if proven care and use techniques become standard practice.

- Be sure to read any safety material/guidelines provided with the abrasive product.
- Always check the wheel for cracks or damage before use.
- Before mounting the wheel, use a tachometer to measure the spindle speed.
- Ensure the mounting flanges, backplate or adapter supplied by the machine manufacturer are properly used and kept in good condition. ANSI Safety Requirement B7.1 provides wheel mounting requirements. Check mounting flanges for equal and correct diameter.
- Never use a grinding wheel with a rated speed less than the grinder.
- Always mount, true and dress the wheel in conformance with the guidelines published in the ANSI Safety Requirements B7.1.
- Ensure the correct wheel guard is in place before starting the wheel. Allow the wheel to come up to full operating speed before starting to grind for a minimum of one minute, and stand out of the plane of rotation.
- NEVER use a high speed air sander as a portable grinder.
- NEVER exceed the maximum operating speed marked on the wheel being used. The following formula may be used to calculate wheel speed:  

$$\text{SPPM} = \text{Spindle Speed in RPM} \times \text{Wheel Diameter in inches} \times .262$$
- Avoid dropping or bumping the wheel.
- When not using the wheel, store the wheel in its original packing materials or according to ANSIB7.1. This protects the wheel and provides easy identification.

For more information on product safety, click on "Safety" on our website: [www.nortonabrasives.com](http://www.nortonabrasives.com) or ask your Norton Distributor for these publications:

- "Primer on Grinding Wheel Safety" (form 474)
- Portable Grinding Safety (form 1406)
- ANSI B7.1 "Safety Requirements for the Use, Care and Protection of Abrasive Wheels"
- Federal Hazard Communication Standard 29 CFR 1910.95, 1910.132, 1910.133, 1910.134, 1910.138 and 1910.1200.
- Material Safety Data Sheets (MSDS)
- Norton Safety Videos
- Other applicable regulations

# UPC # TO PAGE INDEX

UPC #	PAGE #	UPC #	PAGE #	UPC #	PAGE #	UPC #	PAGE #	UPC #	PAGE #	UPC #	PAGE #
07660702462	137	60157662240	55	66243529146	61	66260100670	122	66260114225	117	66260162669	79
07958747944	95	60157663486	55	66243529166	61	66260100681	116	66260114271	120	66260163376	100
07958747945	95	60157663501	55	66243529170	61	66260100687	120	66260114271	116	66260166122	122
07958747946	95	60157663909	55	66243529171	61	66260100700	120	66260114690	120	66260166174	119
07958747947	95	60157664141	55	66243529172	61	66260100701	120	66260114690	116	66260166700	119
07958747948	95	60157668409	55	66252939696	60	66260100702	120	66260114826	120	66260195000	78
07958747950	95	60157669935	57	66252939698	60	66260100703	120	66260114826	116	66260195001	78
07958773216	57	60157670869	57	66252939700	60	66260100707	120	66260118300	56	66260195002	78
07958773217	57	60157680042	57	66252939808	60	66260100708	120	66260119876	57	66260195003	78
07958783054	55	60157682133	55	66252939809	60	66260100716	120	66260127911	56	66260195004	78
07958783055	55	60157690579	115	66252939812	60	66260100722	120	66260127950	56	66260195005	78
07958783057	56	60157691380	57	66252939823	60	66260100731	122	66260135578	61	66260195006	78
07958783058	55	60157692199	56	66252939826	60	66260100740	121	66260135595	61	66260195007	78
07958783059	56	60157693885	115	66252939827	60	66260100741	121	66260141699	101	66260195008	78
07958783060	55	60157696315	56	66252940007	60	66260100742	121	66260141700	101	66260195009	78
07958783061	55	60157696562	56	66252940109	60	66260100743	121	66260141701	101	66260195010	91
07958783062	55	60157697699	57	66252940111	60	66260100744	120	66260142294	102	66260195011	91
07958783063	55	61463610103	63	66252941036	60	66260100745	120	66260142346	102	66260195012	91
07958783064	55	61463610205	63	66252941038	60	66260100746	120	66260142351	102	66260195013	91
07958783065	55	61463610214	63	66252941041	60	66260100747	120	66260142403	102	66260195014	91
07958783067	55	61463610280	63	66252941048	60	66260100751	122	66260142407	102	66260195015	91
07958783068	55	61463610290	63	66252941049	60	66260100759	122	66260142459	102	66260195016	83
07958783070	55	61463610291	63	66252941054	60	66260100779	121	66260142463	102	66260195016	83
07958783071	55	61463610303	63	66252941163	60	66260100786	121	66260142466	102	66260195016	83
07958783073	55	61463610368	63	66252941165	60	66260100798	122	66260142470	102	66260195017	82
07958783074	55	61463610375	63	66252941168	60	66260100803	121	66260142489	102	66260195018	82
07958783085	55	61463610390	63	66252941617	60	66260100805	122	66260142524	101	66260195019	82
07958784316	55	61463610393	63	66252941618	60	66260100816	122	66260142528	101	66260195020	104
60157602944	57	61463610398	63	66252941622	60	66260100820	122	66260142529	101	66260195021	78
60157603873	120	61463610405	63	66252941624	60	66260100821	122	66260145772	78	66260195022	78
60157604003	121	61463610406	63	66252941632	60	66260100826	118	66260145778	78	66260195023	80
60157604008	121	61463610438	63	66252942060	60	66260100936	122	66260148412	95	66260195024	80
60157604072	122	61463610453	63	66252942096	60	66260100984	120	66260148417	95	66260195025	80
60157604098	121	61463610455	63	66252942104	60	66260101129	122	66260148418	95	66260195030	89
60157604139	121	61463610555	63	66252942207	60	66260101271	121	66260151328	97	66260195031	89
60157604315	122	61463610597	63	66253010825	60	66260101453	121	66260151357	97	66260195032	89
60157604420	122	61463610599	63	66253013787	60	66260101454	121	66260151448	98	66260195034	89
60157604423	122	61463610605	63	66253014526	60	66260101495	121	66260151645	98	66260195035	89
60157604435	121	61463647865	63	66253043431	60	66260101515	121	66260151673	98	66260195036	89
60157612442	56	61463647867	63	66253043432	60	66260102106	120	66260155893	101	66260195038	89
60157612443	56	61463650324	63	66253043437	60	66260102369	119	66260156905	77	66260195039	89
60157613099	55	61463650450	63	66253043439	60	66260102408	121	66260156906	77	66260195040	89
60157613112	55	61463691123	137	66253043445	60	66260102768	121	66260156907	77	66260195041	91
60157623498	57	61463691133	137	66253043447	60	66260103303	95	66260156908	77	66260195045	89
60157623524	57	61463691134	137	66253043461	60	66260103305	95	66260157007	77	66260195046	89
60157623542	57	61463691138	137	66253043757	60	66260103306	95	66260157008	77	66260195047	89
60157623563	58	61463691139	137	66253043758	60	66260103307	95	66260157009	77	66260195048	89
60157623605	55	61463691143	137	66253043761	60	66260103532	95	66260157010	77	66260195049	89
60157623673	55	61463691148	137	66253043766	60	66260103534	95	66260158012	98	66260195050	89
60157623776	57	61463691149	137	66253043869	60	66260103535	95	66260158176	99	66260195055	89
60157623944	57	61463691153	137	66253043877	60	66260103545	95	66260158847	101	66260195056	89
60157623953	55	61463691154	137	66253044015	60	66260103555	95	66260158981	96	66260195058	89
60157624551	55	61463691158	137	66253044017	60	66260103741	99	66260158989	101	66260195060	89
60157624551	55	61463691163	137	66253044184	60	66260110959	119	66260159824	101	66260195080	90
60157625123	55	61463691164	137	66253044314	60	66260111494	117	66260159894	79	66260195081	90
60157625123	55	66243529070	61	66253296349	60	66260112444	117	66260160468	78	66260195083	90
60157625728	119	66243529145	61	66253350645	60	66260112980	117	66260162668	79	66260195085	89

# UPC # TO PAGE INDEX

UPC #	PAGE #	UPC #	PAGE #	UPC #	PAGE #	UPC #	PAGE #	UPC #	PAGE #	UPC #	PAGE #
66260195086	89	66260195232	82	66260196007	78	66260196143	98	66260196213	100	66260273605	18
66260195088	89	66260195233	82	66260196011	78	66260196144	98	66260196215	100	66260273607	18
66260195089	89	66260195240	97	66260196014	78	66260196145	98	66260196216	100	66260273609	17
66260195090	91	66260195240	97	66260196015	78	66260196146	98	66260196217	100	66260273611	17
66260195095	89	66260195241	98	66260196018	78	66260196147	98	66260196218	100	66260273612	17
66260195096	89	66260195242	98	66260196019	78	66260196148	98	66260196219	100	66260273613	17
66260195097	89	66260195245	99	66260196022	78	66260196150	99	66260196266	95	66260273614	17
66260195098	91	66260195255	84	66260196023	78	66260196151	99	66260196276	101	66260273615	17
66260195098	91	66260195256	84	66260196026	78	66260196152	99	66260196277	101	66260273617	17
66260195098	91	66260195257	84	66260196027	78	66260196154	99	66260196278	101	66260300134	134
66260195100	81	66260195258	84	66260196034	78	66260196155	99	66260196282	101	66260300197	136
66260195116	78	66260195259	84	66260196035	78	66260196156	99	66260196283	101	66260300202	133
66260195117	78	66260195260	84	66260196098	97	66260196157	99	66260196286	101	66260300203	133
66260195121	78	66260195261	84	66260196099	97	66260196158	99	66260196287	101	66260300360	136
66260195122	78	66260195262	84	66260196100	97	66260196160	99	66260196310	102	66260300362	137
66260195126	78	66260195263	84	66260196101	97	66260196161	99	66260196311	102	66260300363	137
66260195127	78	66260195265	95	66260196102	97	66260196162	99	66260196312	102	66260300368	137
66260195130	78	66260195266	95	66260196103	97	66260196163	99	66260196313	102	66260300372	137
66260195132	78	66260195267	95	66260196104	97	66260196164	99	66260196314	102	66260300375	137
66260195135	78	66260195268	95	66260196105	97	66260196166	99	66260196315	102	66260300376	137
66260195136	78	66260195270	92	66260196106	97	66260196167	99	66260196316	102	66260300377	137
66260195137	78	66260195271	92	66260196107	97	66260196168	99	66260196446	95	66260300379	137
66260195162	80	66260195272	92	66260196108	97	66260196169	99	66260196447	95	66260300380	137
66260195163	80	66260195273	92	66260196109	97	66260196170	99	66260196448	95	66260300381	137
66260195164	80	66260195280	101	66260196110	97	66260196172	99	66260196449	95	66260300383	137
66260195171	80	66260195281	101	66260196111	97	66260196173	99	66260196450	95	66260300384	137
66260195172	80	66260195282	101	66260196112	97	66260196174	100	66260196451	95	66260300386	137
66260195173	80	66260195289	102	66260196113	97	66260196176	99	66260196452	95	66260300388	137
66260195176	97	66260195290	102	66260196114	97	66260196177	99	66260196453	95	66260300389	137
66260195180	80	66260195292	102	66260196115	98	66260196178	100	66260196492	99	66260300390	137
66260195185	81	66260195350	61	66260196116	98	66260196179	100	66260196493	100	66260300391	137
66260195187	81	66260195351	61	66260196117	98	66260196180	100	66260230236	19	66260300392	137
66260195188	81	66260195355	104	66260196118	98	66260196182	99	66260238686	19	66260300393	137
66260195190	81	66260195365	77	66260196119	98	66260196183	99	66260259011	19	66260300394	137
66260195200	103	66260195366	77	66260196120	98	66260196184	100	66260269172	20	66260300396	137
66260195201	103	66260195367	77	66260196121	98	66260196185	100	66260273557	18	66260300398	137
66260195202	103	66260195368	77	66260196122	98	66260196186	100	66260273560	18	66260300399	137
66260195205	103	66260195369	77	66260196123	98	66260196187	100	66260273561	18	66260300400	137
66260195206	103	66260195370	77	66260196124	98	66260196189	99	66260273562	18	66260300402	137
66260195210	83	66260195371	77	66260196125	98	66260196190	99	66260273565	20	66260300403	137
66260195211	83	66260195372	77	66260196126	98	66260196191	100	66260273566	18	66260300404	137
66260195212	83	66260195373	87	66260196127	98	66260196192	100	66260273567	18	66260300406	137
66260195213	83	66260195374	87	66260196128	98	66260196193	100	66260273574	18	66260300407	137
66260195214	83	66260195375	87	66260196129	98	66260196194	100	66260273583	17	66260300408	137
66260195215	83	66260195376	87	66260196130	98	66260196196	100	66260273584	17	66260300409	137
66260195216	83	66260195377	87	66260196131	98	66260196197	100	66260273586	17	66260300410	137
66260195217	83	66260195378	87	66260196132	98	66260196198	100	66260273587	17	66260300412	137
66260195218	83	66260195975	89	66260196133	98	66260196202	100	66260273588	17	66260300413	137
66260195219	83	66260195990	78	66260196134	98	66260196203	100	66260273589	17	66260300414	137
66260195220	83	66260195991	78	66260196135	98	66260196204	100	66260273590	17	66260300415	137
66260195221	83	66260195994	78	66260196136	98	66260196205	100	66260273592	17	66260300416	137
66260195225	82	66260195995	78	66260196137	98	66260196206	100	66260273594	17	66260300417	137
66260195226	82	66260195998	78	66260196138	98	66260196208	100	66260273596	17	66260300667	137
66260195227	82	66260195999	78	66260196139	98	66260196209	100	66260273597	17	66260301989	136
66260195228	82	66260196002	78	66260196140	98	66260196210	100	66260273598	17	66260301990	136
66260195230	82	66260196003	78	66260196141	98	66260196211	100	66260273599	17	66260302086	133
66260195231	82	66260196006	78	66260196142	98	66260196212	100	66260273601	18	66260302087	133

# UPC # TO PAGE INDEX

UPC #	PAGE #	UPC #	PAGE #	UPC #	PAGE #	UPC #	PAGE #	UPC #	PAGE #	UPC #	PAGE #
66260302135	133	66260362989	136	66260392432	127	66260392491	127	66260392550	128	66260392609	129
66260302432	134	66260363015	136	66260392433	128	66260392492	127	66260392551	127	66260392610	129
66260302707	131	66260363036	136	66260392434	128	66260392493	127	66260392552	127	66260392611	128
66260302709	131	66260363371	130	66260392435	127	66260392494	128	66260392553	127	66260392612	128
66260302710	131	66260363450	128	66260392436	127	66260392496	128	66260392554	128	66260392613	128
66260302711	131	66260364008	134	66260392437	128	66260392497	127	66260392555	128	66260392614	129
66260302712	131	66260364241	134	66260392438	128	66260392498	127	66260392556	128	66260392615	129
66260302713	131	66260364253	136	66260392439	127	66260392499	127	66260392557	127	66260392616	129
66260302714	131	66260364258	136	66260392440	127	66260392500	128	66260392559	127	66260392617	128
66260302715	131	66260364301	131	66260392441	128	66260392501	128	66260392560	128	66260392618	128
66260302716	131	66260364302	131	66260392442	128	66260392502	128	66260392561	128	66260392619	128
66260302717	131	66260364303	131	66260392443	127	66260392503	127	66260392562	128	66260392620	129
66260302718	131	66260364304	131	66260392444	127	66260392504	127	66260392563	127	66260392621	129
66260302719	131	66260364305	131	66260392445	127	66260392505	127	66260392564	127	66260392622	129
66260302720	131	66260364306	131	66260392446	128	66260392506	128	66260392565	127	66260392623	128
66260302721	131	66260364307	131	66260392448	128	66260392507	128	66260392566	128	66260392624	128
66260302722	131	66260364308	131	66260392449	127	66260392508	128	66260392567	128	66260392625	128
66260302724	131	66260364309	131	66260392450	127	66260392509	127	66260392568	128	66260392626	129
66260302725	131	66260364310	131	66260392451	127	66260392510	127	66260392569	128	66260392627	129
66260302726	131	66260382018	120	66260392452	128	66260392511	127	66260392570	128	66260392628	129
66260302727	131	66260382018	116	66260392453	128	66260392512	128	66260392571	127	66260392629	129
66260302728	131	66260384227	120	66260392454	128	66260392513	128	66260392572	128	66260392630	129
66260302898	134	66260384227	116	66260392455	127	66260392514	128	66260392573	128	66260392631	129
66260305611	134	66260385384	120	66260392456	127	66260392515	127	66260392574	128	66260392632	129
66260305612	134	66260385384	116	66260392457	127	66260392516	127	66260392575	128	66260392633	129
66260308354	130	66260385394	120	66260392458	128	66260392517	127	66260392576	128	66260392634	129
66260312207	136	66260385394	116	66260392459	128	66260392518	128	66260392577	128	66260392635	129
66260313421	136	66260386661	120	66260392460	128	66260392519	128	66260392578	129	66260392636	129
66260313422	136	66260386661	116	66260392461	127	66260392520	128	66260392579	129	66260392637	129
66260313423	136	66260386801	120	66260392462	127	66260392521	127	66260392580	129	66260392638	129
66260313428	136	66260386801	116	66260392463	127	66260392522	127	66260392581	128	66260392639	129
66260313432	136	66260387133	120	66260392464	128	66260392523	127	66260392583	128	66260392640	129
66260313433	136	66260387133	116	66260392465	128	66260392524	128	66260392584	129	66260392641	129
66260313434	136	66260387481	120	66260392466	128	66260392525	128	66260392585	129	66260392642	129
66260320977	122	66260387481	116	66260392467	127	66260392526	128	66260392586	129	66260392643	129
66260322134	56	66260387592	120	66260392468	127	66260392527	127	66260392587	128	66260392644	129
66260322280	55	66260387592	116	66260392469	127	66260392528	127	66260392588	128	66260392645	129
66260329275	57	66260387692	120	66260392471	128	66260392529	127	66260392589	128	66260392646	129
66260329385	57	66260387692	116	66260392472	128	66260392530	128	66260392590	129	66260392647	129
66260329388	57	66260388852	116	66260392473	127	66260392531	128	66260392591	129	66260392648	129
66260329391	57	66260389554	116	66260392474	127	66260392532	128	66260392592	129	66260392649	129
66260329400	118	66260389753	120	66260392475	127	66260392533	127	66260392593	128	66260392650	129
66260329461	57	66260389753	116	66260392476	128	66260392534	127	66260392594	128	66260392651	129
66260329469	56	66260391021	117	66260392477	128	66260392535	127	66260392595	128	66260392652	129
66260329604	56	66260391464	136	66260392478	128	66260392536	128	66260392596	129	66260392653	129
66260329663	121	66260391473	136	66260392479	127	66260392537	128	66260392597	129	66260392654	129
66260329670	121	66260391474	136	66260392480	127	66260392538	128	66260392598	129	66260392655	129
66260329675	121	66260391729	134	66260392481	127	66260392540	127	66260392599	128	66260392656	129
66260329680	121	66260391730	134	66260392482	128	66260392541	127	66260392600	128	66260392657	129
66260329681	122	66260391731	134	66260392483	128	66260392542	128	66260392601	128	66260392658	129
66260329688	122	66260391732	134	66260392484	128	66260392543	128	66260392602	129	66260392659	129
66260329696	122	66260391733	134	66260392485	127	66260392544	128	66260392603	129	66260392660	129
66260329705	122	66260391734	134	66260392486	127	66260392545	127	66260392604	129	66260392661	129
66260329709	122	66260391830	134	66260392487	127	66260392546	127	66260392605	128	66260392662	129
66260329714	120	66260392429	127	66260392488	128	66260392547	127	66260392606	128	66260392663	129
66260362981	136	66260392430	128	66260392489	128	66260392548	128	66260392607	128	66260392664	129
66260362985	136	66260392431	127	66260392490	128	66260392549	128	66260392608	129	66260392665	129



# UPC # TO PAGE INDEX

UPC #	PAGE #	UPC #	PAGE #	UPC #	PAGE #	UPC #	PAGE #	UPC #	PAGE #	UPC #	PAGE #
66260392666	129	66260392724	130	66260395431	130	66260395525	131	66260395597	133	69014118235	58
66260392667	129	66260392725	130	66260395432	130	66260395526	131	66260395598	133	69014118237	57
66260392668	129	66260392726	130	66260395433	132	66260395527	131	66260395599	133	69014118238	57
66260392669	129	66260392727	130	66260395434	132	66260395528	131	66260395600	133	69014118239	57
66260392670	129	66260392728	130	66260395435	132	66260395529	131	66260395601	133	69014118240	57
66260392671	129	66260392729	128	66260395436	132	66260395530	135	66260395602	133	69014118241	58
66260392672	129	66260392730	128	66260395437	132	66260395531	135	66260395603	133	69014118242	58
66260392673	129	66260392731	128	66260395438	132	66260395532	135	66260395604	133	69014118248	58
66260392674	129	66260392732	129	66260395439	132	66260395533	135	66260395605	134	69014118254	58
66260392675	129	66260392733	129	66260395440	132	66260395534	135	66260395606	134	69014118255	55
66260392676	129	66260392734	129	66260395441	132	66260395535	135	66260395607	134	69014118256	57
66260392677	129	66260392735	128	66260395442	132	66260395536	135	66260395608	134	69014118257	56
66260392678	129	66260392736	128	66260395443	132	66260395537	135	66260395609	134	69014118259	56
66260392679	129	66260392737	128	66260395444	132	66260395538	135	66260395611	134	69014118260	58
66260392680	129	66260392738	129	66260395445	132	66260395539	135	66260395613	134	69014118262	57
66260392681	129	66260392739	129	66260395446	132	66260395540	130	66260395614	134	69014118263	55
66260392682	129	66260392740	129	66260395447	132	66260395541	130	66260395615	134	69014118264	57
66260392683	129	66260392741	128	66260395448	132	66260395542	130	69014117679	57	69014118265	56
66260392684	129	66260392742	128	66260395449	132	66260395543	130	69014117684	55	69014118266	58
66260392685	129	66260392743	128	66260395450	132	66260395544	130	69014117812	56	69014118342	57
66260392686	129	66260392744	129	66260395483	132	66260395545	130	69014117820	58	69014118345	58
66260392687	129	66260392745	129	66260395484	132	66260395549	135	69014117833	58	69014118406	58
66260392688	129	66260392746	129	66260395485	132	66260395550	135	69014117838	56	69014118435	57
66260392689	129	66260392747	128	66260395486	132	66260395551	135	69014118029	58	69014118436	57
66260392690	129	66260392748	128	66260395487	132	66260395552	135	69014118043	58	69014118441	58
66260392691	129	66260392749	128	66260395488	132	66260395553	135	69014118200	55	69014118445	58
66260392692	129	66260392750	129	66260395489	132	66260395554	136	69014118201	55	69014118447	57
66260392693	130	66260392751	129	66260395490	132	66260395555	136	69014118202	55	69014118470	58
66260392694	130	66260392752	129	66260395491	132	66260395556	136	69014118203	55	69014118479	56
66260392695	130	66260392753	128	66260395492	132	66260395557	136	69014118204	55	69014118543	57
66260392696	130	66260392754	128	66260395493	132	66260395559	136	69014118205	55	69014118644	56
66260392697	130	66260392755	128	66260395494	132	66260395560	136	69014118206	55	69014122944	115
66260392698	130	66260392756	129	66260395495	132	66260395561	136	69014118207	55	69014122946	115
66260392699	130	66260392757	129	66260395496	132	66260395563	136	69014118208	55	69014122947	115
66260392700	130	66260392758	129	66260395497	132	66260395565	136	69014118209	56	69014122948	115
66260392701	130	66260392841	131	66260395498	132	66260395566	136	69014118210	56	69014122950	115
66260392702	130	66260392842	134	66260395499	132	66260395567	136	69014118211	56	69014122952	115
66260392703	130	66260392843	134	66260395500	132	66260395575	134	69014118212	56	69014122953	115
66260392704	130	66260392844	134	66260395501	132	66260395576	134	69014118213	56	69014122954	115
66260392706	130	66260392845	134	66260395502	132	66260395577	134	69014118215	56	69014122955	115
66260392707	130	66260392846	134	66260395503	132	66260395578	134	69014118216	55	69014122956	115
66260392708	130	66260392847	134	66260395504	132	66260395579	134	69014118217	55	69014123079	117
66260392709	130	66260392849	135	66260395505	132	66260395580	134	69014118219	56	69014123080	117
66260392710	130	66260392850	135	66260395506	132	66260395581	134	69014118221	56	69014141373	57
66260392711	130	66260392851	135	66260395507	132	66260395582	134	69014118222	56	69014185716	116
66260392712	130	66260392852	135	66260395508	132	66260395585	133	69014118223	57	69014185718	116
66260392713	130	66260392853	135	66260395509	132	66260395586	133	69014118224	57	69014185732	116
66260392714	130	66260392854	135	66260395510	132	66260395587	133	69014118225	57	69014185734	120
66260392715	130	66260395422	136	66260395516	131	66260395588	133	69014118226	57	69014185734	116
66260392716	130	66260395423	136	66260395517	131	66260395589	133	69014118227	57	69014185735	116
66260392717	130	66260395424	136	66260395518	131	66260395590	133	69014118228	57	69014185736	116
66260392718	130	66260395425	136	66260395519	131	66260395591	133	69014118229	57	69014185737	116
66260392719	130	66260395426	130	66260395520	131	66260395592	133	69014118230	57	69014185738	120
66260392720	130	66260395427	130	66260395521	131	66260395593	133	69014118231	57	69014185738	116
66260392721	130	66260395428	130	66260395522	131	66260395594	133	69014118232	57	69014185746	116
66260392722	130	66260395429	130	66260395523	131	66260395595	133	69014118233	58	69014185747	116
66260392723	130	66260395430	130	66260395524	131	66260395596	133	69014118234	58	69014190751	21

# UPC # TO PAGE INDEX

UPC #	PAGE #	UPC #	PAGE #	UPC #	PAGE #	UPC #	PAGE #	UPC #	PAGE #	UPC #	PAGE #
69014191623	20	69014191693	17	69014191855	18	69014192140	17	69014192192	17	69014192311	18
69014191628	23	69014191695	17	69014191856	18	69014192141	17	69014192197	17	69014192312	18
69014191629	23	69014191696	17	69014191857	18	69014192142	17	69014192203	17	69014192313	18
69014191630	23	69014191698	18	69014191858	19	69014192143	17	69014192205	17	69014192314	18
69014191631	21	69014191700	18	69014191860	20	69014192144	17	69014192210	18	69014192316	18
69014191632	21	69014191701	18	69014191904	21	69014192149	17	69014192211	18	69014192325	18
69014191634	21	69014191703	18	69014191905	21	69014192150	17	69014192212	18	69014192363	21
69014191635	21	69014191704	18	69014191906	21	69014192151	19	69014192217	20	69014192427	21
69014191636	21	69014191705	18	69014191908	21	69014192152	19	69014192221	20	69014192428	17
69014191637	21	69014191706	19	69014191909	21	69014192155	19	69014192223	23	69014192761	19
69014191638	21	69014191707	19	69014191910	21	69014192156	19	69014192226	23	69014192764	17
69014191639	21	69014191715	22	69014191913	21	69014192157	19	69014192227	23	69014192769	17
69014191640	21	69014191716	22	69014191914	21	69014192158	19	69014192228	23	69014192770	17
69014191641	21	69014191719	22	69014191916	21	69014192159	19	69014192229	23	69014192771	17
69014191643	21	69014191720	22	69014191917	21	69014192160	19	69014192230	23	69014192772	17
69014191644	21	69014191721	22	69014191918	21	69014192161	19	69014192235	17	69014192773	17
69014191645	21	69014191722	22	69014192020	23	69014192162	19	69014192236	17	69014192777	18
69014191646	21	69014191723	22	69014192021	18	69014192163	19	69014192238	17	69014192779	18
69014191647	21	69014191724	22	69014192022	21	69014192164	19	69014192240	17	69014192780	18
69014191648	21	69014191725	21	69014192024	17	69014192165	19	69014192243	17	69014192784	23
69014191649	21	69014191832	22	69014192060	19	69014192166	19	69014192248	17	69014192786	20
69014191650	21	69014191833	22	69014192063	19	69014192167	19	69014192249	17	69014192799	20
69014191651	21	69014191834	22	69014192064	19	69014192168	19	69014192251	17	69014192810	21
69014191652	21	69014191835	22	69014192067	19	69014192169	19	69014192258	17	69014192814	21
69014191653	21	69014191837	22	69014192068	19	69014192170	19	69014192260	17	69014192815	19
69014191654	21	69014191838	22	69014192069	19	69014192172	19	69014192266	17	69014195679	22
69014191656	21	69014191839	22	69014192070	19	69014192173	19	69014192272	17	69014195680	22
69014191657	21	69014191840	22	69014192082	19	69014192174	17	69014192276	17	69014195682	22
69014191658	21	69014191841	22	69014192083	19	69014192175	17	69014192277	17	69014195683	22
69014191660	21	69014191842	22	69014192086	19	69014192176	17	69014192280	20	69014195685	22
69014191665	20	69014191843	22	69014192088	19	69014192177	17	69014192291	21	69014195686	22
69014191670	17	69014191844	22	69014192099	19	69014192178	17	69014192292	21	69936664144	60
69014191671	17	69014191848	18	69014192105	19	69014192179	17	69014192293	21		
69014191672	17	69014191849	18	69014192108	19	69014192180	17	69014192302	19		
69014191677	17	69014191852	18	69014192110	19	69014192182	17	69014192305	18		
69014191691	17	69014191853	18	69014192114	19	69014192184	17	69014192306	18		
69014191692	17	69014191854	18	69014192139	17	69014192187	17	69014192310	18		

# NORTON HAS THE MOST COMPREHENSIVE LINE OF PREMIUM SUPERABRASIVE PRODUCTS

## *Also available:*



### **Norton MSL (Metal Single Layer) Wheels and Tools**

Get superior performance when grinding or cutting friction or composite materials. Norton MSL wheels and tools consist of a single, uniform layer of diamond or cBN in a metal bond, and always offer the advantages of long life and consistent cut rates.



### **Norton/Winter Made-To-Order Electroplated Products**

Our Norton/Winter quality electroplated products are engineered to your exact requirements. We will manufacture them to your blueprints or design a product to produce the desired profile from your component blueprints.



### **Micro-Grinding with Planetary Kinematics (GPK) Products**

Engineered for high-production grinding, targeted at applications with flatness value requirements of 0.1 – 1 $\mu$ m. Available in diamond and cBN abrasives, vitrified and resin bonds.



### **Vitrified cBN Wheels Excel in High-Production Applications**

Achieve complex geometries, tight tolerances, and burn-free finishes on hard-to-grind materials – along with high metal removal rates.



### **Norton Rotary Dressing Tools**

The premier dressing solutions for high-speed grinding.



### **Wheel Dressing and Norton Dressing Infeed Systems and Spindles**

With speeds ranging from 1,000 to 20,000+ RPMs, high torque, and their compact design, these systems are ideal for any truing and dressing requirements.

*All Norton Superabrasive products are manufactured in state-of-the-art facilities, and are supported by a dedicated and knowledgeable team of Sales Representatives, CSRs, and Application Engineers. All these products can be ordered through our extensive network of authorized distributors.*





# DIAMOND AND cBN SUPERABRASIVE STANDARD PRODUCTS



## Paradigm Diamond CNC Wheels for Round Tool and Insert Grinding

Lights out, on-line truable CNC wheels. Ground-breaking invention of an extreme porosity metal bond system. Maximize your productivity and lower your costs today with the Paradigm Shift in grinding.



## G-Force/Univel CNC Wheels for Round Tool Grinding

The performance standard for carbide and steel round tool grinding with metal/hybrid technology: high form-holding capability, premium abrasives and a unique bond ensure lasting sharp cutting edges. Available in cBN and diamond abrasives.



## Norton B99, B99E and Special Resin Stock Grinding Wheels

Largest diamond and cBN resin-bonded offering for wet and dry MRO and toolroom applications. Time-tested, consistent, and reliable. 250+ stock wheels and over 65,000 express lead time made-to-order wheels.



## Single Layer Wheels and Tools

From mounted points to hand hones, files, and blades, a complete selection of single layer stock diamond and cBN tools for the ceramic, tool and die, composite, and MRO markets. Also available, made-to-order high-precision and production CNC single layer products for automotive, aerospace, bearing, and cutting tool applications.



## Norton Stationary Dressing Tools

One of the most comprehensive stock offerings in the industry made with the highest quality diamonds for consistent performance and geometries. Our lean manufacturing facility can also make your made-to-order designs in short lead times.

### BEST

Highest Productivity – Lowest Total Cost

### BETTER

Excellent Blend of Performance and Price

### GOOD

Consistent Performance – Low Initial Price

[www.facebook.com/NortonIndustrial](http://www.facebook.com/NortonIndustrial) | [www.youtube.com/NortonIndustrial](http://www.youtube.com/NortonIndustrial) | [www.nortonindustrial.com](http://www.nortonindustrial.com)

#### USA CUSTOMER SERVICE:

Toll Free Phone: 1 (800) 551-4413  
Toll Free Fax: 1 (800) 551-4416

#### CANADA CUSTOMER SERVICE:

Toll Free Phone: 1 (800) 263-6565  
Toll Free Fax: 1 (800) 561-9490

#### FORM #8068 REV. 07/14

© Saint-Gobain July 2014.  
Norton is a registered trademark of Saint-Gobain Abrasives.

