



HIGH PRECISION WELDING TABLES



[WWW.STRONGHANDTOOLS.COM](http://WWW.STRONGHANDTOOLS.COM)

**StrongHandTools**

Siegmund is committed to producing the world's finest welding and fixture tables.

For 2015 we are pleased to present our biggest leap forward with the debut of the **Professional Extreme 750 Tables**. We have taken our proprietary material, machining, and hardening processes to the next level with a new standard in table hardness and toughness.

Our newest tables are welded from through hardened tool steel before undergoing a newly developed machining process that gives Siegmund tables their distinctive rounded edges and unsurpassed functionality.

Its signature aesthetics and hardness are imparted with a newly optimized hardening process which results in a deep, hard case that prolongs the life of the table surface and creates a glossy black shine.

The results are the world's hardest, most versatile welding tables that are suitable for every workspace and every job.

The unsurpassed technical excellence of Siegmund tables is complemented by a wide range of mounting options and improved fixture accessories with new features such as hardened finishes, numbered scales, and rounded edges.

*Visit our website to see the latest additions to the Siegmund product line and download CAD drawings.*

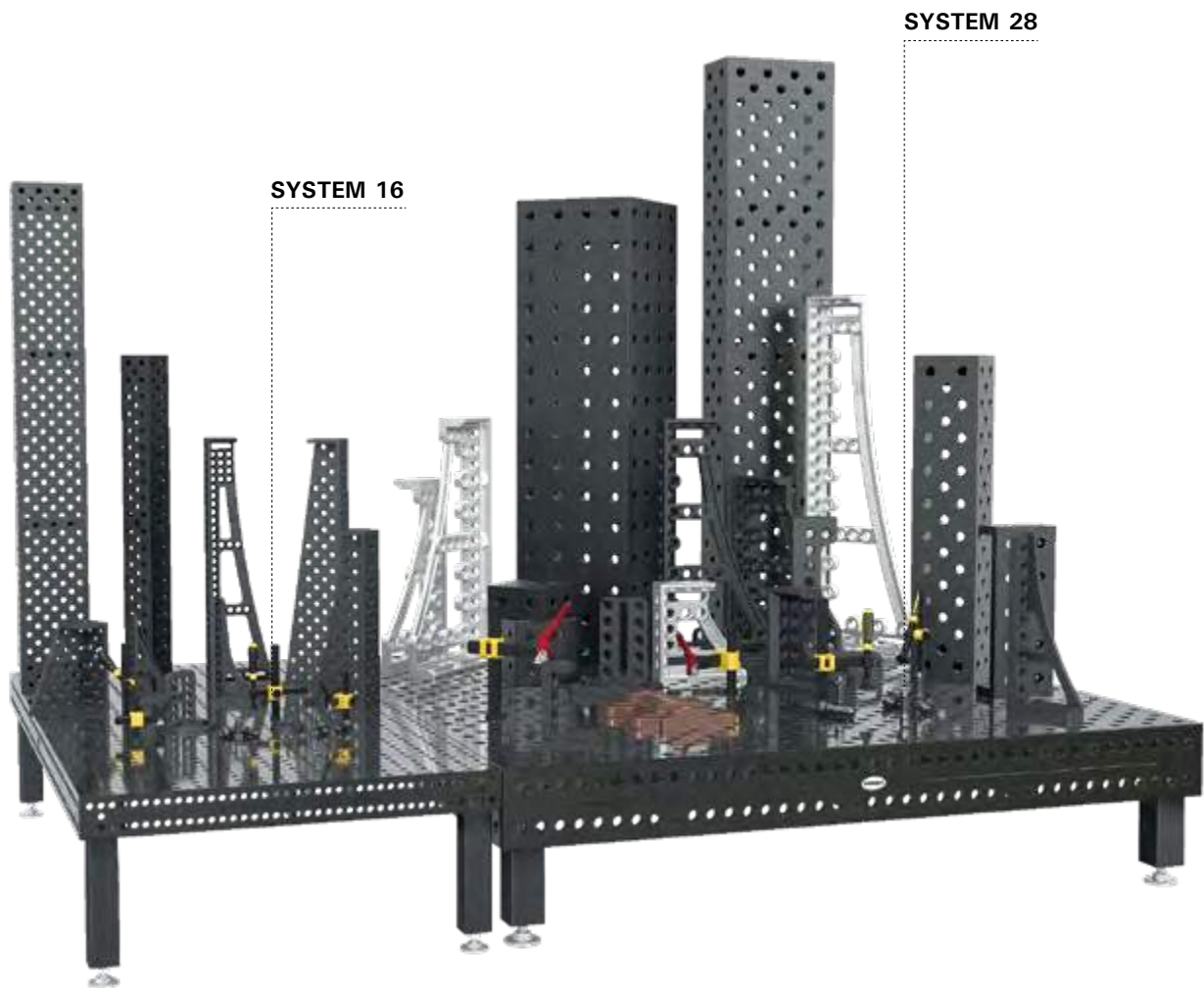

# S28 EXTREME 750 TABLES

## NEW! PROFESSIONAL EXTREME 750

All System 28 Professional Extreme tables now feature the latest upgrades in aesthetics, versatility, and durability. Our **Double Hardened Tables** are constructed from through hardened steel before undergoing a **Plasma Nitride** treatment to provide you with a table of superior quality and performance.

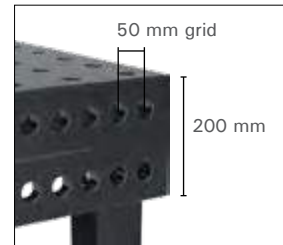
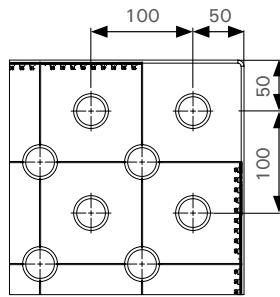

### MATERIAL THICKNESS

approx. 24.5 - 27 mm

### VICKERS HARDNESS GRADE

Table top: Surface hardness: approx. 750  
Table side: Surface hardness: approx. 550

\* The four side faces are still constructed from our standard, high quality S355J2+N (St 52/3) Steel to provide the ideal balance of properties for performance, durability, and cost.

### TABLE SURFACE

- borehole spacing 100 mm (standard grid) with additional 100 mm grid offset by 50 mm in the x and y axis, aka diagonal grid
- grid line spacing 100 mm
- 0 - 100 mm repeating scale on table sides

### TABLE SIDE PANEL

- 200 mm high
- additional boreholes enable parallel clamping in a 50 mm wide by 100 mm high grid



### ELABORATE RADIUSSES

- 3 mm radius of top table edge reduces damages to Siegmund accessories and customers components
- 6 mm radius on edges reduces risk of injury



### SYSTEM BOREHOLE

- Ø 28.15 mm
- radius R3 for boreholes on the table surface allow for faster insertion of bolts and accessories
- large chamfer on table underside for maximum clamping force of bolts

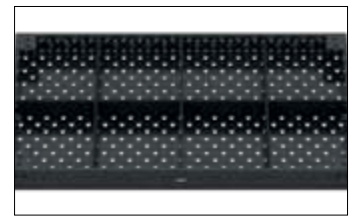

### RIBBING

- load capacity of over 10 metric tons
- increased rib height

## FIVE-FACE TABLES

1,000 x 1,000 x 200 mm Professional Extreme 750



*Requires 4 Legs. (Sold Separately.)*

1,200 x 800 x 200 mm Professional Extreme 750



*Requires 4 Legs. (Sold Separately.)*

1,200 x 1,200 x 200 mm Professional Extreme 750



*Requires 4 Legs. (Sold Separately.)*

2,000 x 1,000 x 200 mm Professional Extreme 750



*Requires 4 Legs. (Sold Separately.)*

4,000 x 2,000 x 200 mm Professional Extreme 750



1,500 x 1,000 x 200 mm Professional Extreme 750



*Requires 4 Legs. (Sold Separately.)*

2,000 x 2,000 x 200 mm Professional Extreme 750



*Requires 4 Legs. (Sold Separately.)*



Name	Part Number (Diagonal Grid)	Length (mm)	Width (mm)	Height (mm)	Table Weight (kg)	Length (in)*	Width (in)*	Height (in)*	Table Weight (lb)*
S28- 1 x 1 Meter Professional Extreme 750 with Diagonal Grid	S2-280010-XD7	1,000	1,000	200	371	39.4	39.4	7.9	816
S28- 1.2 x 0.8 Meter Professional Extreme 750 with Diagonal Grid	S2-280025-XD7	1,200	800	200	363	47.2	31.5	7.9	799
S28- 1.2 x 1.2 Meter Professional Extreme 750 with Diagonal Grid	S2-280015-XD7	1,200	1,200	200	493	47.2	47.2	7.9	1,085
S28- 2.0 x 1.0 Meter Professional Extreme 750 with Diagonal Grid	S2-280020-XD7	2,000	1,000	200	673	78.7	39.4	7.9	1,481
S28- 2.4 x 1.2 Meter Professional Extreme 750 with Diagonal Grid	S2-280030-XD7	2,400	1,200	200	918	94.5	47.2	7.9	2,020
S28- 1.5 x 1.0 Meter Professional Extreme 750 with Diagonal Grid	S2-280035-XD7	1,500	1,000	200	526	59.1	39.4	7.9	1,157
S28- 2.0 x 2.0 Meter Professional Extreme 750 with Diagonal Grid	S2-280045-XD7	2,000	2,000	200	1,217	78.7	78.7	7.9	2,677
S28- 3.0 x 1.5 Meter Professional Extreme 750 with Diagonal Grid	S2-280040-XD7	3,000	1,500	200	1,411	118.1	59.1	7.9	3,104
S28- 4.0 x 2.0 Meter Professional Extreme 750 with Diagonal Grid	S2-280055-XD7	4,000	2,000	200	2,380	157.5	78.7	7.9	5,236

\* Values approximate. Values truncated (not rounded).

Siegmund Welding Tables come with a wide range of mounting options to suit every workspace. Legs are ordered individually and the quantity required will vary depending on table size.

Legs mount onto plates at the bottom of the table; to calculate height of work surface add the height of the leg and the height of the table together. For example, the 750 mm Standard Leg combined with a table height of 200 mm results in a 950 mm high work surface. Leveling feet with spindles at the bottom of the legs offer fine adjustment.



#### BEARING LOAD PER LEG

The maximum bearing load per leg in system 28 is max. 800 - 2,000 kg for all tables depending on the leg type.

The indicated bearing loads are calculated with reserves for safety reasons.

Please consult with manufacturer if higher overall loads are required.

Item Number	Name	Height (mm)	Spindle Adj. Range (mm)	Static Load Capacity (kg)	Weight (kg)
S2-280858-X	Leg Standard equipment 650	650	50	2,000	8.5
S2-280857-X	Leg Standard equipment 750	750	50	2,000	9.0
S2-280878-X	Leg height-adjustable 450 - 700	450 - 700	50	2,000	9.2
S2-280876-X*	Leg with Caster and Locking Brake 650	650	20	800	9.0
S2-280879-X*	Leg height - adjustable with Caster and Locking Brake 550 - 750	550 - 750	20	800	11.0
S2-280874-X	Leg with Floor Anchoring 650	650	50	2,000	10.5
S2-280875-X	Leg with Floor Anchoring 750	750	50	2,000	11.0

\* *Tipping and Pinching Danger - Only transport tables on castors when table is not in use. Proceed slowly and use extra caution around uneven surfaces. Hitting cracks while rolling may create unsafe shearing forces on the legs. Rolling across uneven surfaces may cause one or more legs to be abruptly raised and lowered back onto the ground, creating a pinch hazard.*



#### INSTALLATION

##### TABLE LEGS:

Two 14 mm hex drive cap screws with spring rings are included with each leg.

Each table leg bolt should be tightened with a torque of 150 Nm.

#### MAXIMUM SAFE BEARING LOAD:

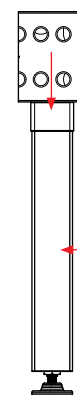

Vertical force direction:

20 kN

Horizontal force direction:

2 kN

Maximum stability ensured by large section tube (90 x 90 mm).

## Fixtures for Stainless Steel

*(Special Order)*

Aluminum Overlay Sheets are available for stainless steel welding. Sheets come in standard and diagonal hole patterns to align precisely with the table's existing hole pattern. Overlay sheet is 2 mm thick and can be used with standard Siegmund fast clamp bolts (does not require Universal Bolt).

Fixture sets are also available for stainless steel work using a combination of stainless steel, aluminum, aluminum-titanium, and chromed fixtures. Non-marring polyamide pads and V-Prisms also available.

### ALUMINUM-TITANIUM STOP AND CLAMPING SQUARES



Aluminum Overlay Sheet



Diagonal Grid

## Positioner Mounting Options

*(Special Order)*

Custom sized plates for applications such as positioner or turntable use can be manufactured on request.

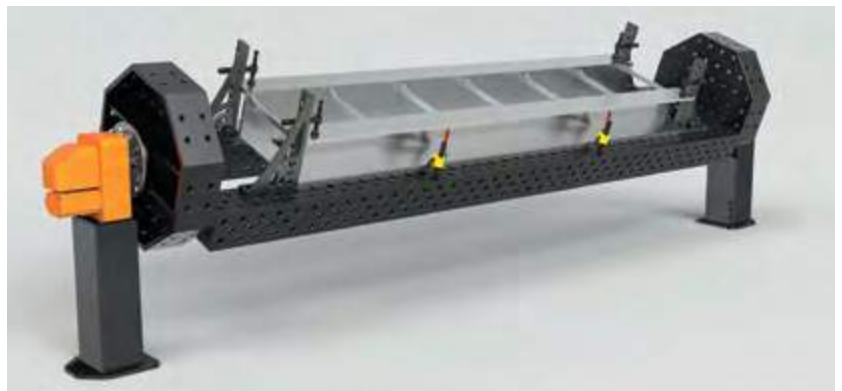
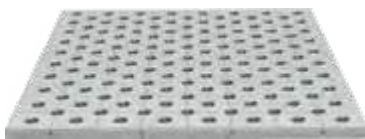



S2-280407



S2-280408



S2-280409



S2-280410-N



S2-280420-N



S2-280430



S2-280432

Stops are used to align work pieces anywhere on the table. Oblong slots provide adjustment while holes provide anchoring points for accessories such as clamps and V-Prisms.

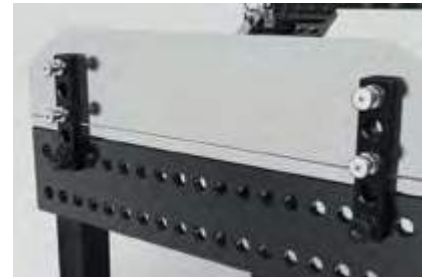

Item Number	Name	Length (mm)	Width (mm)	Thickness (mm)	Slot Length (mm)	Weight (kg)
S2-280407	Universal Stop 100 L	100	50	25	--	0.8
S2-280408	Universal Stop 150 L	150	50	25	--	1.1
S2-280409	Universal Stop 250 L	250	50	25	--	1.8
S2-280410-N	Universal Stop 150 L (Nitrided)	150	50	25	100	0.8
S2-280420-N	Universal Stop 225 L (Nitrided)	225	50	25	100	1.4
S2-280430	Universal Stop 500 S	500	100	25	200	7.9
S2-280432	Universal Stop 750 S	750	100	25	200	12.1





S2-280402



S2-280403



S2-280445



S2-280444



S2-280105



S2-280107

Eccentric Stops provide infinite adjustment in a compact package. Item S2-280402 can also be used as a ground connection and features an M10 thread.

Flat Squares provide a broad adjustable stopping surface and an alternate, compact method of creating right angle fixtures.

Small stop and clamping squares are used for mounting in tight spaces.

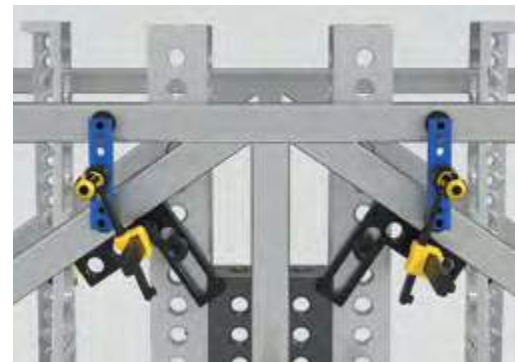
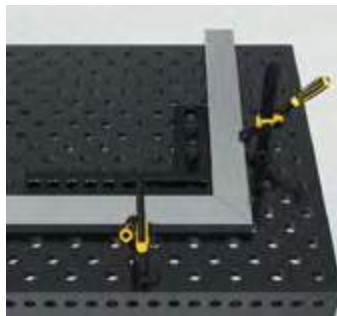

Item Number	Name	Length (mm)	Width (mm)	Thickness (mm)	Weight (kg)
S2-280402	Eccentric Stop 60	--	Ø: 60	25	0.4
S2-280403	Eccentric Stop 100	--	Ø: 100	25	1.4
S2-280445	Flat Square 175 - 100 mm slot	175	175	25	1.9
S2-280444	Flat Square 500 - 200 mm slot	500	375	25	12.0
S2-280105	Stop and Clamping Square 75 L	75	50	25	1.0
S2-280107	Mounting Square	75	150	25	2.9



S2-280109



S2-280110-N



S2-280111



S2-280113



S2-280114



S2-280112



Stop and Clamping Squares can be used in the same manner as a stop or combined with other elements to form more complex fixtures. Oblong slots enable a range of adjustable options.

Item Number	Name	Length (mm)	Width (mm)	Height (mm)	Thickness (mm)	Weight (kg)
S2-280109	Stop and Clamping Square 175 x 75 SL	175	50	75	25	1.4
S2-280110-N	Stop and Clamping Square 175 L (Nitrided)	175	50	175	25	2.0
S2-280111	Stop and Clamping Square 175 WL	175	50	175	25	1.8
S2-280113	Stop and Clamping Square VL	175	50	175	25	2.4
S2-280114	Stop and Clamping Square 200 L	175	50	200	25	2.7
S2-280112	Stop and Clamping Square 275 L	175	50	275	25	2.8



S2-280152



S2-280162



S2-280164 S2-280165



S2-280166-P S2-280167-P



Cast Stop and Clamping Squares are manufactured from high quality ductile cast iron. Their larger size and more robust construction allows them to stop larger parts and bear heavier loads when used as a table extension. Their cast construction means greater precision while cut outs are optimized for lighter weight and easier handling. New clamping squares with rotation slots provide more ways to create angled fixtures.

Some squares come in two versions with stops on either the left or right side.

Item Number	Name	Length (mm)	Width (mm)	Height (mm)	Thickness (mm)	Weight (kg)
S2-280152	Stop and Clamping Square 300 G - stop on left	200	75	300	approx. 27	6.0
S2-280162	Stop and Clamping Square 500 G	200	75	500	approx. 27	9.4
S2-280164 S2-280165	Stop and Clamping Square 500 G with rotation Slot - stop on left / right	276	95	500	approx. 27	11.5
S2-280166-P S2-280167-P	Stop and Clamping Square 750 G Plasma nitrided. - stop on left / right.	276	85	750	approx. 27	13.6

## HEAVY DUTY CAST SQUARES

3D Stop and Clamping Squares are manufactured from high quality ductile cast iron and specifically designed to handle heavy parts.

They serve equally well for stopping large parts, serving as table extensions, or building vertically. Cut outs are optimized for lighter weight and easier handling, while the hardening process makes them even stronger and more durable.

Aluminum-titanium versions featuring 50 - 60% weight reductions also available on special order.

Squares come in two versions with stops on either the left or right side.



S2-280124-P S2-280126-P



S2-280130-P S2-280132-P



S2-280134-P S2-280136-P



S2-280144-P S2-280146-P

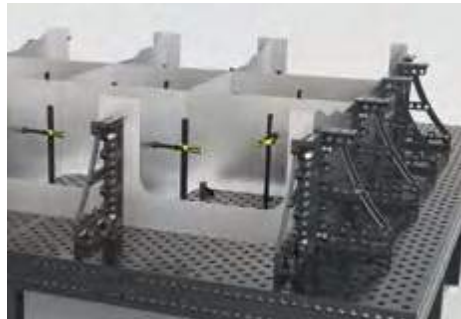

Item Number	Name	Length (mm)	Width (mm)	Height (mm)	Thickness (mm)	Weight (kg)
S2-280124-P S2-280126-P	L / R Stop & Clamping Square 300 GK (Nitrided)	280	95	300	approx. 27	12.9
S2-280130-P S2-280132-P	L / R Stop & Clamping Square 500 GK (Nitrided)	280	95	500	approx. 27	17.5
S2-280134-P S2-280136-P	L / R Stop & Clamping Square 600 GK (Nitrided)	376	95	600	approx. 27	22.5
S2-280144-P S2-280146-P	L / R Stop & Clamping Square 800 GK (Nitrided)	376	95	800	approx. 27	27.0



S2-280370-P

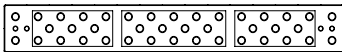

Riser Blocks are ideally suited as table extensions or for joining multiple tables together for long projects. Riser blocks are plasma nitride hardened. Riser blocks 200 mm and 500 mm in length do not have leg mounting holes.

Riser blocks 1,000 mm and longer in length have leg mounting holes, and all blocks over 500 mm in length should be supported by legs when used as a table extension. Visit our product website for more information about mounting legs onto riser blocks.

**SAFETY NOTE:** Riser Blocks should only be joined to the table using connector bolts (Item S2-280560 or S2-280550-1). Do not use fast clamping bolts or other available bolts to join.

Custom Riser Blocks can be ordered with profiles of 200 x 200 mm, 400 x 200 mm, and 400 x 400 mm (width x height) in lengths up to 4,000 mm.

Item Number	Description	Length (mm)	Width (mm)	Height (mm)	Weight (kg)
S2-280396-1-P	Riser Block 200 x 200 x 200	200	200	200	32
S2-280360-P	Riser Block 500 x 200 x 200	500	200	200	68
S2-280370-P	Riser Block 1,000 x 200 x 200	1,000	200	200	130
S2-280380-P	Riser Block 1,500 x 200 x 200	1,500	200	200	190
S2-280390-P	Riser Block 2,000 x 200 x 200	2,000	200	200	245
S2-280391-P	Riser Block 2,400 x 200 x 200	2,400	200	200	290
S2-280392-P	Riser Block 3,000 x 200 x 200	3,000	200	200	365



**The Support and Clamping Frame** features bore holes on a 50 mm grid with slots. Two versions with stops on either left or right side.

**The Corner Square** is used to mount clamping squares or U-shapes at table corners to extend the work surface. S2-280191-G can also be used as large V-blocks to hold round tubing in place when mounted with low profile bolts (S2-280522).

**Angle Protractor w/ Spacer Sleeve** allows adjustment in 10 degree increments or continuously variable from 0 - 90 degrees with 1 degree scale.

**Adjustable Angle Bracket** provides high repeat accuracy from 10 - 150 degrees. Angle can be set with included pins and angle template.

**Load-Bearing Adjustable Angle** uses a hydro mechanical mechanism and angle guide to lock angle into position.



S2-280300



S2-280301



S2-280190-G



S2-280191-G



S2-280455



S2-280170



S2-280171



Item Number	Description	Length (mm)	Width (mm)	Height (mm)	Weight (kg)
S2-280300	Support and Clamping Frame, <b>nitrided</b> - stop on right	300	200	100	19.5
S2-280301	Support and Clamping Frame, <b>nitrided</b> - stop on left	300	200	100	19.5
S2-280190-G	Corner Connection, Cast Iron	200	150	120	11.8
S2-280191-G	Corner Connection, Cast Iron	200	200	175	19.7
S2-280455	Angle Protractor w/ 20 mm Spacer Sleeve (S2-280538)	250	250	5	1.5
S2-280170	Adj. Angle Bracket w/ angle template, non-load bearing	350	--	--	14.5
S2-280171	Load Bearing Adj. Angle	475	--	--	23.0



S2-280303-P

Item Number	Description	Length (mm)	Width (mm)	Height (mm)	Weight (kg)
S2-280303-P	Clamping Rail 1,000 x 100 x 100	1,000	100	100	48



S2-280302



S2-280195

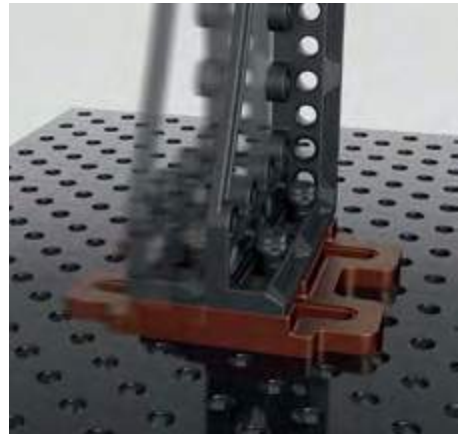

The Sliding Base and Slotted Square together provide 3-axis adjustment for heavy fixtures. They work especially well in combination with Flange Clamping Plates and 3D Clamping Squares for pipefitting applications.

The Sliding Base should be bolted to the table with a low profile clamping bolt, item S2-280522 to ensure proper clearance between the base and clamping square when sliding.



Item Number	Description	Length (mm)	Width (mm)	Thickness (mm)	Weight (kg)
S2-280302	Slotted Adj. Square Cast Iron	500	100	100	16
S2-280195	Sliding Base	350	300	50	16

## FLANGE MOUNTING



S2-280250-P



S2-280251-P



S2-280252-P

Clamping plates come in various sizes for ANSI / ASME and DIN sizes. Included with each clamping plate are a set of pins to hold different flange sizes in place, refer to specification table to see which pins are included.



Item Number	Description	Length (mm)	Width (mm)	Thickness (mm)	Weight (kg)	Pins included w/ plate (2 x ea.)
S2-280250-P	Clamping Plate 150 lbs Nitrided with Fixing Bolt for flange US standard ANSI / ASME B 16.5 150 lbs from 1/2" to 8"	350	250	25	14	S2-280255, S2-280257, S2-280256
S2-280251-P	Clamping Plate 300 lbs Nitrided with Fixing Bolt for flange US standard ANSI / ASME B 16.5 300 lbs from 1/2" to 8"	350	250	25	14	S2-280255, S2-280259, S2-280256, S2-280258
S2-280252-P	Clamping Plate 400 - 600 lbs Nitrided with Fixing Bolt for flange US standard ANSI / ASME B 16.5 400 - 600 lbs from 1/2" to 6"	350	250	25	14	S2-280255, S2-280256, S2-280257, S2-280258, S2-280259



S2-280255



S2-280256



S2-280257



S2-280258



S2-280259

Item Number	Description	Length (mm)	Dia. (mm)	Dia. (in)	Weight (kg)
S2-280255	Fixing Bolt Ø 15.5	39	15.5	0.610	0.03
S2-280256	Fixing Bolt Ø 18.9	41	18.9	0.744	0.05
S2-280257	Fixing Bolt Ø 22.2	45	22.2	0.874	0.10
S2-280258	Fixing Bolt Ø 25.2	50	25.2	0.992	0.14
S2-280259	Fixing Bolt Ø 28.2	50	28.2	1.110	0.16



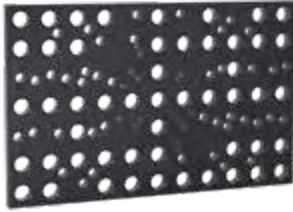

S2-280220-P



S2-280221-P

Item Number	Description	Length (mm)	Width (mm)	Thickness (mm)	Weight (kg)	Pins included w/ plate (2 x ea.)
S2-280220-P	Clamping Plate 550 for DIN Flanges Nitrided with Fixing Bolt For flanges DIN 2632 / 2633, nominal widths DN 15 - DN 400. For flanges DIN 2634 / 2635, nominal widths DN 50 - DN 300.	550	350	25	30	S2-280222, S2-280223, S2-280224, S2-280225, S2-280226, S2-280227
S2-280221-P	Clamping Plate 350 for DIN Flanges Nitrided with Fixing Bolt For flanges DIN 2633, nominal width DN 15 - DN 200.	350	250	25	14	S2-280222, S2-280223, S2-280224



S2-280222



S2-280223



S2-280224



S2-280225



S2-280226



S2-280227

Item Number	Description	Length (mm)	Dia. (mm)	Weight (kg)
S2-280222	Fixing Bolt Ø 13.8 for bore 8.1	39	13.8	0.03
S2-280223	Fixing Bolt Ø 17.8 for bore 10.1	41	17.8	0.05
S2-280224	Fixing Bolt Ø 21.8 for bore 16.1	47	21.8	0.10
S2-280225	Fixing Bolt Ø 25.8 for bore 16.1	50	25.8	0.14
S2-280226	Fixing Bolt Ø 29.8 for bore 16.1	55	29.8	0.20
S2-280227	Fixing Bolt Ø 32.8 for bore 16.1	60	32.8	0.27

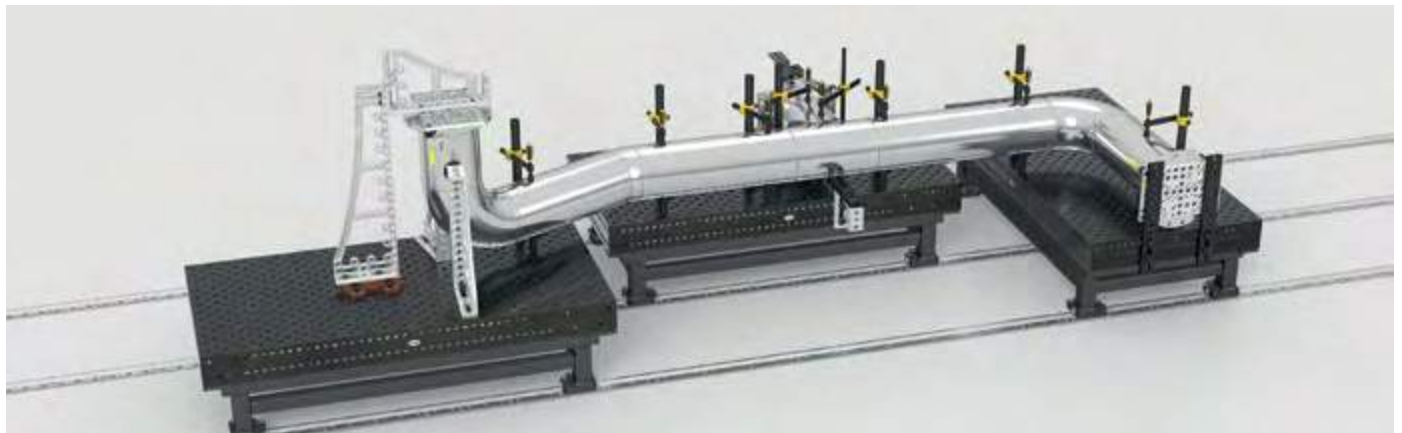

Lightning-fast and optimized

DUE TO ITS WELL-ENGINEERED MECHANISM

IT CAN BE CLAMPED AND RELEASED BY HAND WITHIN SECONDS.

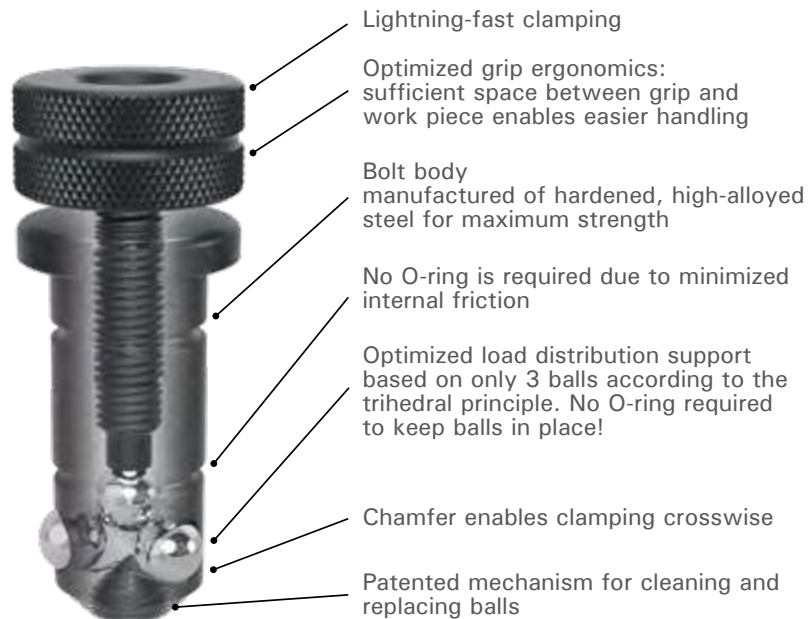

#### TIGHTENING TORQUE (AM)

The tightening torque is the force required to fasten the bolt using a torque wrench. In order to achieve maximum clamping force, the tightening torque should not exceed the recommended guideline.

The bolt was designed to only require a low torque to reach maximum clamping force, thereby enabling simple manual clamping.

Max. AM of 280510:  $\leq 25$  Nm



#### SHEARING FORCE (SK)

The shearing force is the force which reacts laterally to the cross-sectional area of the bolt.

Max. SK of 280510:  $\leq 220$  kN



#### TENSILE FORCE (ZK)

The tensile force is the force created when pulling on fixed bolts.

Max. ZK of 280510:  $\leq 25$  kN

All bolts come in short and long versions. Short bolts are designed for connecting two Siegmund components together such as a table to a stop or a stop to a square. Long bolts are designed for connecting three Siegmund components together. Connecting Bolts are used to join heavy parts such as riser blocks to tables.



S2-280510



S2-280512



S2-280532



S2-280533



S2-280540

**Fast clamping Bolts** - Standard bolts used for the majority of applications. Tighten by hand or with 6 mm hex key.

**Universal Bolts** - Designed for backward compatible use with legacy welding table fixture kits or custom fixtures that are slightly thicker or thinner than standard Siegmund parts. Tighten by hand or with 14 mm hex key.

Quick positioning bolt for applications where clamping force is not required.



S2-280528



S2-280529



S2-280522



S2-280550-1



S2-280560



S2-280561

**Flush Mount / Flat Bolts** - Used to connect components without the bolt head interfering with the work piece. Tighten with 6 mm hex key.

**\* Connecting Bolts** - The only bolt permitted for use to form connections with heavy parts such as Riser Blocks to tables. Standard connecting bolt tightens with 36 & 24 mm wrench. Flush mount bolts tighten with 10 mm hex key on both ends.

Item Number	Name	Length (mm)	Dia. (mm)	Weight (kg)	Notes	SK (kN)	AM (Nm)	ZK (kN)
S2-280510	Fast Clamping Bolt, Short	95	28	0.5	Standard bolt for use when combining 2 Siegmund components	220	25	25
S2-280512	Fast Clamping Bolt, Long	120	28	0.7	Standard bolt for use when combining 3 Siegmund components	220	25	25
S2-280532	Universal Bolt, Short	100	28	0.6	45 - 53 mm clamping zone	200	25	25
S2-280533	Universal Bolt, Long	125	28	0.7	70 - 78 mm clamping zone	200	25	25
S2-280540	Positioning Bolt, Short	70	28	0.4	For positioning applications where clamping force is not required.	--	--	--
S2-280528	Flush Mount Bolt, Short	67	28	0.3	Flush Mount head not suitable for placement in oblong slots	220	25	10
S2-280529	Flush Mount Bolt, Long	91	28	0.4	Flush Mount head not suitable for placement in oblong slots	220	25	10
S2-280522	Flat Clamping Bolt, Short	74	28	0.4	Low profile bolt for use in oblong holes such as for sliding base plate (S2-280195)	220	25	25
S2-280550-1*	Connecting Bolt, Hex, Short	58	28	0.4	For connecting Riser Blocks or large squares to table side w/ slots	200	25	20
S2-280560*	Flush Mount Connecting Bolt, Short	50	28	0.1	For connecting Riser Blocks or large squares to table side	200	25	10
S2-280561*	Flush Mount Connecting Bolt, Long	75	28	0.2	For connecting Riser Blocks or large squares to table side	200	25	10



S2-280648-1



S2-280651-1



S2-280647-1



S2-280652-1



S2-280670

V-Prisms are used for holding round stock of different sizes. Included in the delivery of V-prisms are a screw-in collar (S2-280669) and countersunk bolt. This enables the V-prism to be used flat on the table or with system holes.

The clamping cone is clamped to 28 mm bore holes using fast clamping bolts.

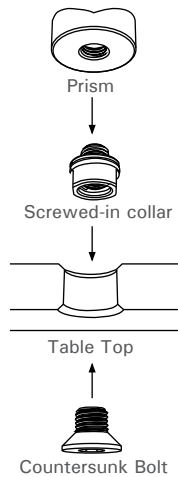

Item Number	Name	Hole Mount	Height (mm)	Dia. (mm)	Prism Degree	Weight (kg)
S2-280648-1	Prism $\varnothing$ 50 135° with screwed-in collar	M16	20	50	135	0.2
S2-280651-1	Prism $\varnothing$ 60 135° with screwed-in collar	M16	30	60	135	0.5
S2-280647-1	Prism $\varnothing$ 80 90° with screwed-in collar	M16	40	80	90	1.0
S2-280652-1	Prism $\varnothing$ 120 157° with screwed-in collar	M16	30	120	157	1.7
S2-280670	Clamping Cone	28 mm	70	80	--	1.4

## PRISM EXTENSIONS



S2-280822



S2-280821



S2-280649



S2-280649-1



S2-280649-2



S2-280669

Combine the Screw Support with Shim Sets and Prism Extensions to achieve infinitely variable height adjustment.

The 11-pc Shim Set can be combined with prism extensions to create offsets in your fixtures. Note the shim set storage tube does not act as a prism extension.



Item Number	Name	Height (mm)	Dia. (mm)	Weight (kg)
S2-280822	Screw Support Ø 80	75 - 110	80	2.30
S2-280821	Set of Shim Supports 11-piece set Disc thickness: 1 / 2 / 3 / 4 / 5 mm 10 / 20 / 40 / 50 mm 1/10 inch disc (2.54 mm) + storage holder	125	50	1.95
S2-280649	Prism Extension 25	25	28	0.11
S2-280649-1	Prism Extension 50	50	28	0.22
S2-280649-2	Prism Extension 100	100	28	0.45
S2-280669	Prism Collar Screw with countersunk bolt	27	28	0.07



S2-280610

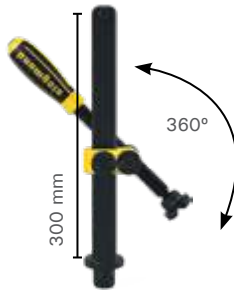

S2-280630

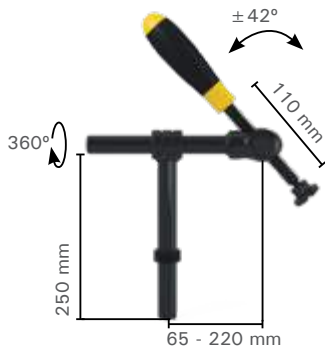

S2-280604



S2-280608

Versatile clamping systems ensure a clamp for your every need. All clamps easily set with one hand and feature interchangeable pads for work with sensitive materials.

The Standard Screw Clamp adjusts by hand along the vertical and horizontal axis for precise placement anywhere on the table.

The Basic Pipe Clamp Universal features horizontal and vertical adjustment as well as pivoting action at the spindle head. An adjustment ring at the base allows it to sit in a lower profile during welding as the round bar sits below the table or clamping square surface.

Spindle and bushings from item S2-280610 can be removed by hand and inserted into system holes for clamping with stops and squares.



Item Number	Name	Vertical Bar Height (mm)	Horizontal Bar Length (mm)	Weight (kg)
S2-280610	Screw Clamp Standard	310	200, 40 - 165 Clamping Range	2.7
S2-280630	Screw Clamp Standard 45 / 90	310	170 Spindle Length	2.3
S2-280604	Basic Pipe Clamp Universal	250	110	2.3
S2-280608	Basic Pipe Clamp 90°	200	100	1.4



S2-280706



S2-280707



S2-280740



S2-280740-1



S2-280741



S2-280210



S2-280211



Table Mount C-Clamp for repetitive clamping. Clamping range can be set with adjusting screw.

Magnetic Clamping Bolt, enables fast clamping without bolting or the use of tools. It is preferable for pressure-sensitive parts like thin sheet metal, as well as enclosed shapes.

Clamping Bridges offer the possibility to clamp in difficult to reach areas or clamp multiple work pieces simultaneously. Pads can be shifted along the clamping bridge to better place the pressure.



Item Number	Name	Clamping Length (mm)	Clamping Range (mm)	Length (mm)	Width (mm)	Height (mm)	Dia. (mm)	Weight (kg)
S2-280706	Quick-Change Clamp 100	100	5 - 75	340	30	150	28	1.2
S2-280707	Quick-Change Clamp 160	160	0 - 75	360	30	150	28	1.2
S2-280740	Magnetic Clamping Bolt	--	--	68	--	--	34	0.09
S2-280740-1	Magnetic Clamping Bolt	--	--	93	--	--	34	0.13
S2-280741	Spacer Ring for magnetic bolt	--	--	--	--	25	40	0.12
S2-280210	Two Point Clamping Bridge	--	--	170	35	20	--	0.8
S2-280211	Three Point Clamping Bridge	--	--	170	35	20	--	1.0



S2-280910

The wheeled Siegmund Tool Carts keep your parts organized and nearby at all times. The Tool Cart (S2-280910) can store numerous clamps, bolts, stops and squares on the top and front, while the back side stores up to 8x clamping squares up to 800 mm in height.

Comes with 2 fixed wheels and 2 swiveling castors.



S2-280911

The top of this Compact Tool Cart (S2-280911) features divided bulk storage areas, ideal for storing frequently used accessories, such as clamping & fixing bolts. Bottom features storage for large clamping squares.

The Compact Tool Cart conveniently rolls beneath a table with 650 mm or more bottom clearance for space saving storage.



\*Cart and tools sold separately.

Item Number	Name	Length (mm)	Width (mm)	Height (mm)	Weight (kg)
S2-280910	Tool Cart	660	900	1,040	50
S2-280911	Tool Cart Compact	1,000	750	636	59



S2-000810

28 mm Ground Connection guarantees 100% contact to the welding table. Install by simply fastening it in a system bore hole.

Fits Cable cross sections 70 - 95 mm<sup>2</sup> (cable not included).

Item Number	Name	Load Rating
S2-000810	28 mm Ground Connection	500 Ampere







S2-000830

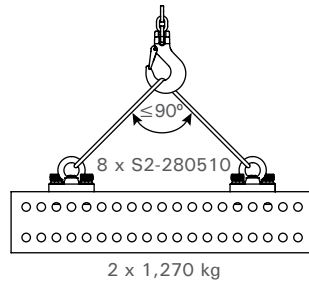
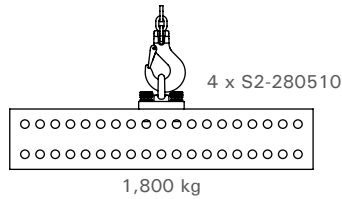

The Lifting Bracket with Eye Nut has a load bearing capacity of 1,800 kg and is used for transport of tables and other heavy components safely and easily. It is fastened quickly using 4 clamping bolts (S2-280510). Lateral forces should be avoided on the lifting bracket eye nut as this will decrease its load capacity.

The Lifting Bracket with Safety Hoist Ring has a load bearing capacity of 2,200 kg and is used for transport of tables and other heavy components safely and easily. It is fastened quickly using 4 clamping bolts (S2-280510). The safety hoist ring maintains a consistent load bearing capacity even with lateral force components as long as its swivel and pivot motions are not impeded by other objects.

With all lifting brackets users must observe general rules and regulations for material handling safety. Users must ensure Eye Nut or Hoist Rings are fully threaded and sit flat on the bearing surface. Users must ensure clamping bolts are fully seated onto the lifting bracket so that bolts can achieve full clamping capacity. Objects should not be lifted further than 100 mm off the ground and personnel are not allowed under objects being lifted or moved.





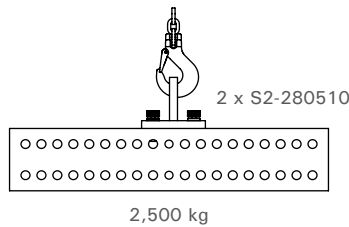





S2-000835



Item Number	Name	Length (mm)	Width (mm)	Height (mm)	Weight (kg)
S2-000830	Lifting Bracket with eye nut - 1,800 kg load-bearing capacity	150	150	25	4.7
S2-000835	Shipping Bracket - 2,500 kg load-bearing capacity	200	100	165	4.5

## FIXTURING KITS

Choose a fixture kit from below or contact us for consultation on a fixture kit to meet your specific needs. All fixture kits come with the accessory pack below for basic maintenance.

Fixture Kit #1	S2-283100	32pcs	Weight: 47 kg / 164 lbs		
					
S2-280610	S2-280630	S2-280648-1	S2-280510	S2-280410-N	S2-280420-N
4 x	2 x	2 x	12 x	4 x	4 x
					
S2-280110-N	S2-280152				
2 x	2 x				

Fixture Kit #2	S2-283200	56pcs	Weight: 88 kg / 196 lbs		
					
S2-280610	S2-280630	S2-280648-1	S2-280510	S2-280740	S2-280410-N
6 x	4 x	4 x	18 x	4 x	6 x
					
S2-280420-N	S2-280110-N	S2-280152	S2-280162		
6 x	4 x	2 x	2 x		

Fixture Kit #3	S2-283300	76pcs	Weight: 162 kg / 363 lbs		
					
S2-280610	S2-280630	S2-280648-1	S2-280510	S2-280740	S2-280410-N
10 x	6 x	4 x	24 x	4 x	8 x
					
S2-280420-N	S2-280110-N	S2-280152	S2-280162	S2-280166P + S2-2801667-P	
8 x	6 x	2 x	2 x	1 x + 1 x	

Fixture Kit #4	S2-283400	109pcs	Weight: 278 kg / 624 lbs			
						
S2-280610	S2-280630	S2-280648-1	S2-280510	S2-280740	S2-280410-N	S2-280420-N
14 x	10 x	6 x	30 x	8 x	10 x	10 x
						
S2-280430	S2-280110-N	S2-280152	S2-280162	S2-280164 + S2-280165	S2-280166-P + S2-280167-P	S2-280910
4 x	8 x	2 x	2 x	1 x + 1 x	1 x + 1 x	1 x

Fixture Kit #5	S2-283500	127pcs	Weight: 348 kg / 780 lbs				
							
S2-280610	S2-280630	S2-280648-1	S2-280510	S2-280740	S2-280410-N	S2-280420-N	S2-280430
14 x	10 x	8 x	36 x	8 x	12 x	12 x	4 x
							
S2-280110-N	S2-280152	S2-280162	S2-280164 + S2-280165	S2-280166-P + S2-280167-P	S2-280144-P + S2-280146-P	S2-280910	
12 x	2 x	2 x	1 x + 1 x	1 x + 1 x	1 x + 1 x	1 x	

Accessory pack S2-283999 comes with each Siegmund fixture kit.

				
S2-280402	S2-280852-1	S2-280820	S2-000940	S2-280920

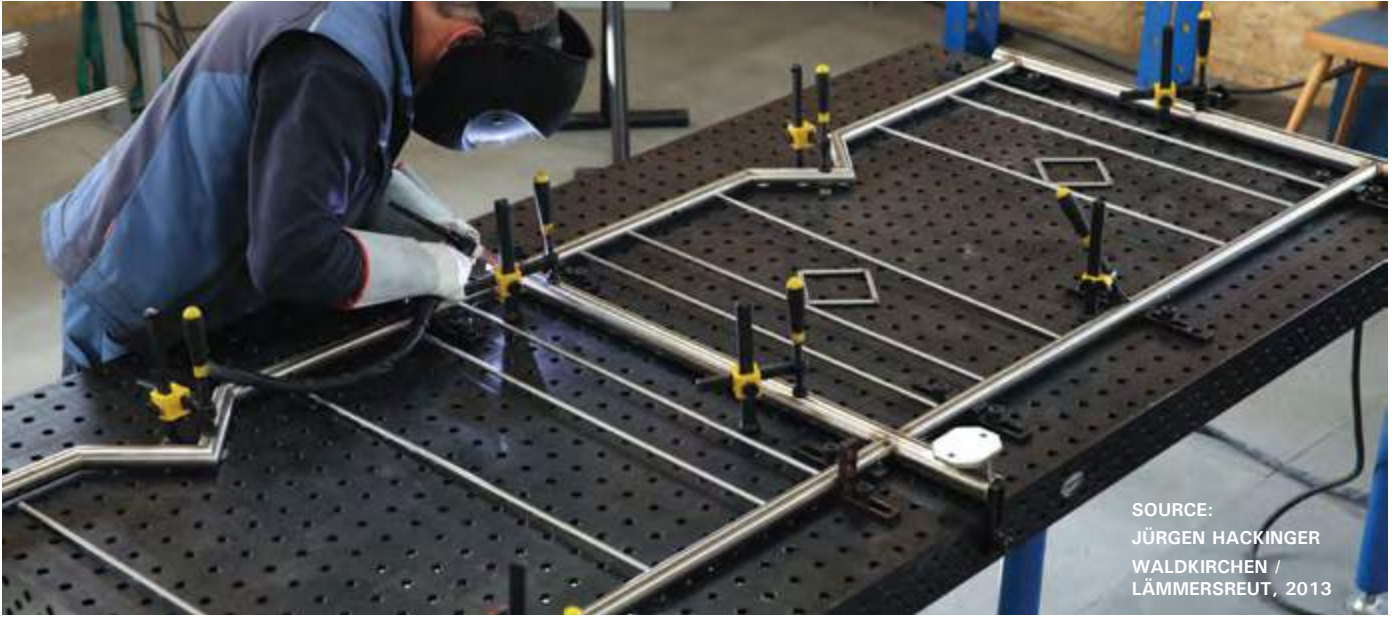

SOURCE:  
JÜRGEN HACKINGER  
WALDKIRCHEN /  
LÄMMERSREUT, 2013

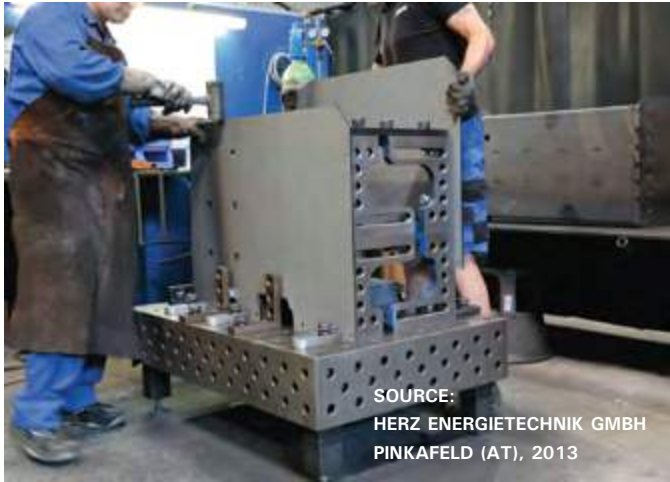

SOURCE:  
HERZ ENERGIETECHNIK GMBH  
PINKAFELD (AT), 2013



SOURCE:  
BHDT GMBH  
HÖNIGSBERG (AT), 2013



SOURCE:  
BUILDING COMPANY  
MATTHÄUS SCHMID  
BALTRINGEN, 2011



SOURCE:  
MAN BUS SP. Z O.O.  
STARACHOWICE (PL), 2014



SOURCE:  
SEMET MASCHINENBAU  
GMBH & CO. KG  
BRACKENHEIM, 2013



SOURCE:  
MAN BUS SP. Z O.O.  
STARACHOWICE (PL), 2014



SOURCE:  
STADLER BUSSNANG AG  
BUSSNANG (CH), 2014



SOURCE:  
MARKTHALER GMBH & CO. KG  
KAUFBEUREN, 2011

Welding table, work bench or mobile workshop – the new revolutionary Siegmund Workstation combines all advantages.

### Professional Extreme 8.9

1200 x 800 x 12 mm

Table top is manufactured of specially developed Siegmund X8.7 through hardened alloy tool steel

Borehole Ø 16 mm

Boreholes on the surface in 50 mm interval

The whole Siegmund accessories (System 16) are compatible with the Siegmund Workstation.

Each workstation is delivered with easy self-assembly instructions.



Item Number	Name	Weight (kg)
S2-167100	Work station with casters including accessories	168

#### (INCLUDED)

S2-160620	S2-160510	S2-160420-N	S2-160108-N	S2-160110-N	S2-163999
4 x	12 x	8 x	4 x	2 x	1 x



#### TABLE TOP

The table plate is made of throughhardened tool steel. For the hardening process Siegmund uses a specially developed alloy.



#### LEGS

The combined foot and castor gives mobility to the Siegmund Workstation. Base plates have fine adjustment to enable a precise working surface.



#### SUFFICIENT STORAGE

The Siegmund Workstation features defined storage for tooling and accessories that can be shelved for easy reach.





*The new revolutionary workbench  
from the world market leader*



# SYSTEM 28 COMPARISON TO SYSTEM 16

## SYSTEM 28

*Meets all requirements. From light to heavy constructions*

## SYSTEM 16

*For light to medium constructions*

	SYSTEM 28	SYSTEM 16
Borehole Ø (mm)	28	16
Borehole spacing (mm)	100	50
Borehole spacing (Table side panel) (mm)	50	25
Grid spacing (mm)	100 + 100 (offset by 50 mm x and y)	50
Table side panel (mm)	200	100
Material thickness (mm)	25	12

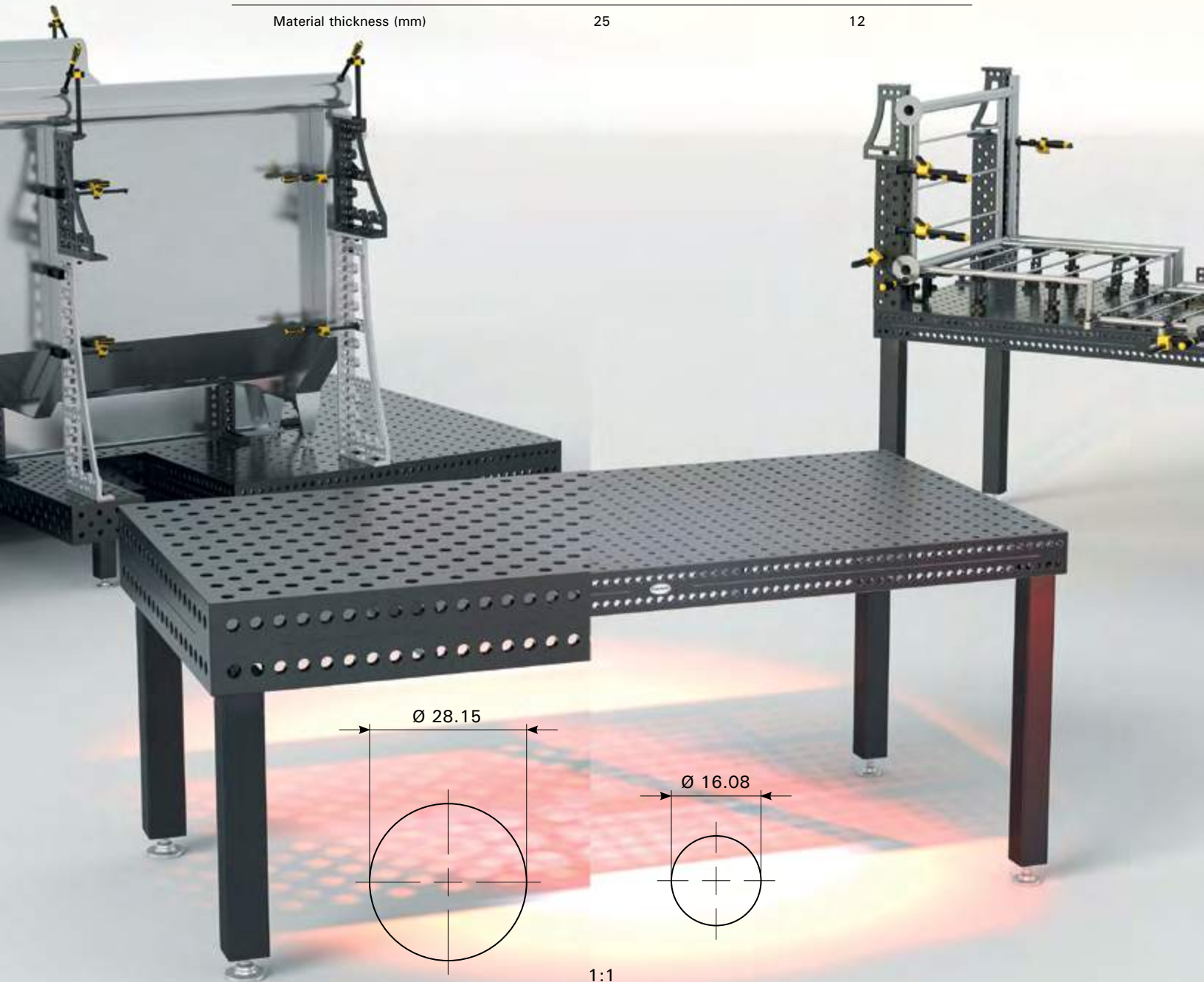

## INTRODUCTION TO SYSTEM 16

### NEW! PROFESSIONAL EXTREME 750

All System 16 Professional Extreme Tables now feature the latest upgrades in aesthetics, versatility, and durability. Our **Double Hardened Tables** are constructed from through hardened steel before undergoing a **Plasma Nitride** treatment to provide you with a table of superior quality and performance.



**MATERIAL THICKNESS**  
11.5 - 13 mm

**VICKERS HARDNESS GRADE**

Table top: Surface hardness: approx. 750  
Table side: Surface hardness: approx. 550

\* The four side faces are still constructed from our standard, high quality S355J2 + N (St 52/3) Steel to provide the ideal balance of properties for performance, durability, and cost.

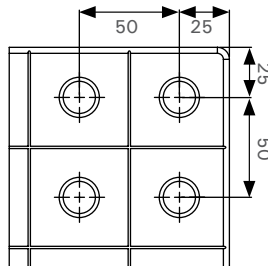

**DATA**

- borehole spacing 50 mm
- grid element spacing 50 mm

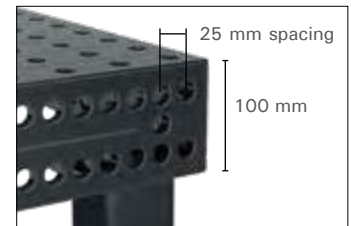

**TABLE SIDE PANEL**

- 100 mm high
- additional boreholes enable parallel clamping in a 25 mm wide by 50 mm high grid



**ELABORATE RADIUSSES**

- 3 mm radius of top table edge reduces damages to Siegmund accessories and customers components
- 6 mm radius on edges reduces risk of injury



**SYSTEM BOREHOLE**

- Ø 16 mm
- radius R2 for boreholes on the table surface for faster clamping
- large chamfer on table underside for maximum clamping force of bolts

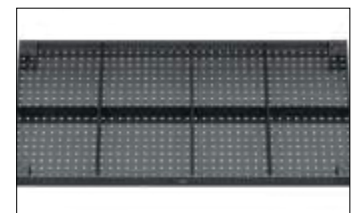

**RIBBING**

Multiple ribbing on the underside for maximum stability and precision.

## PROFESSIONAL TABLES

1,000 x 500 x 100 mm Professional Extreme



*Requires 4 Legs. (Sold Separately.)*

1,200 x 800 x 100 mm Professional Extreme



*Requires 4 Legs. (Sold Separately.)*

1,200 x 1,200 x 100 mm Professional Extreme



*Requires 4 Legs. (Sold Separately.)*

1,200 x 1,200 x 100 mm Professional Extreme



*Requires 4 Legs. (Sold Separately.)*

1,500 x 3,000 x 100 mm Professional Extreme



2,000 x 1,000 x 100 mm Professional Extreme



*Requires 4 Legs. (Sold Separately.)*

1,200 x 2,400 x 100 mm Professional Extreme



*Requires 6 Legs. (Sold Separately.)*



*Requires 6 Legs. (Sold Separately.)*



Name	Part Number (Standard Grid)	Length (mm)	Width (mm)	Height (mm)	Table Weight (kg)	Length (in)*	Width (in)*	Height (in)*	Table Weight (lb)*
S16- 1.0 x 0.5 Meter Professional Extreme 750	S2-160005-X7	1,000	500	100	104	39.4	19.7	3.9	229
S16- 1.2 x 0.8 Meter Professional Extreme 750	S2-160025-X7	1,200	800	100	171	47.2	31.5	3.9	376
S16- 1.2 x 1.2 Meter Professional Extreme 750	S2-160015-X7	1,200	1,200	100	237	47.2	47.2	3.9	521
S16- 2.0 x 1.0 Meter Professional Extreme 750	S2-160020-X7	2,000	1,000	100	330	78.7	39.4	3.9	726
S16- 2.4 x 1.2 Meter Professional Extreme 750	S2-160030-X7	2,400	1,200	100	466	94.5	47.2	3.9	1,025
S16- 1.5 x 1.0 Meter Professional Extreme 750	S2-160035-X7	1,500	1,000	100	257	59.1	39.4	3.9	565
S16- 3.0 x 1.5 Meter Professional Extreme 750	S2-160040-X7	3,000	1,500	100	746	118.1	59.1	3.9	1,641

\* Values approximate. Values truncated (not rounded).

Siegmund Welding Tables come with a wide range of mounting options to suit every workspace. Legs are ordered individually and the quantity required will vary depending on table size.

Legs mount onto plates at the bottom of the table; to calculate height of work surface add the height of the leg and the height of the table together. For example, the 750 mm Standard Leg combined with a table height of 100 mm results in a 850 mm high work surface. Leveling feet with spindles at the bottom of the legs offer fine adjustment.



#### BEARING LOAD PER LEG

The maximum bearing load per leg in system 16 is max. 200 - 1.000 kg for all tables depending on the leg type.

The indicated bearing loads are calculated with reserves for safety reasons.

Please consult with manufacturer if higher overall loads are required.

Item Number	Name	Height (mm)	Spindle Adj. Range (mm)	Static Load Capacity (kg)	Weight (kg)
S2-160857-X	Leg Standard equipment 850	850	40	1,000 Per leg	6.70
S2-160858-X	Leg Standard equipment 750	750	40	1,000	6.10
S2-160877-X	Leg height - adjustable 550 - 950	550 - 950	40	1,000	7.00
S2-160876-X*	Leg with Caster and Locking Brake 750	750	40	200	7.00
S2-160879-X*	Leg height - adjustable with Caster and Locking Brake 600 - 900	600 - 900	40	200	8.00
S2-160873-X	Leg with Floor Anchoring 850	850	50	1,000	9.30
S2-160875-X	Leg with Floor Anchoring 750	750	50	1,000	8.30

\* *Tipping and Pinching Danger - Only transport tables on castors when table is not in use. Proceed slowly and use extra caution around uneven surfaces. Hitting cracks while rolling may create unsafe shearing forces on the legs. Rolling across uneven surfaces may cause one or more legs to be abruptly raised and lowered back onto the ground, creating a pinch hazard.*



#### INSTALLATION

##### TABLE LEGS:

Two 14 mm hex drive cap screws with spring rings are included with each leg.

Each table leg bolt should be tightened with a torque of 150 Nm.

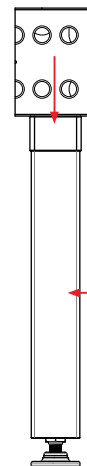

#### MAXIMUM SAFE BEARING LOAD:

Vertical force direction:

10 kN

Horizontal force direction:

Maximum stability ensured by large section tube (70 x 70 mm).

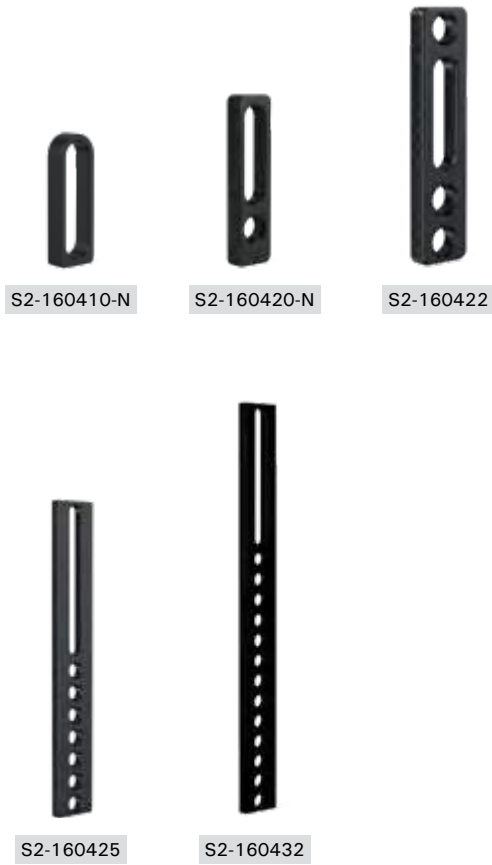

Stops are used to align work pieces anywhere on the table. Oblong slots provide adjustment while holes provide anchoring points for accessories such as clamps and V-Prisms.

Item Number	Name	Length (mm)	Width (mm)	Thickness (mm)	Adj. Range (mm)	Weight (kg)
S2-160410-N	Universal Stop 75 L - Nitrided	75	30	12	50	0.07
S2-160420-N	Universal Stop 115 L - Nitrided	115	30	12	50	0.20
S2-160422	Universal Stop 150 L	150	35	12	50	0.33
S2-160425	Universal Stop 300 M	300	50	12	--	1.08
S2-160432	Universal Stop 500 M	500	50	12	--	1.85



S2-160401



S2-160402

Eccentric Stops provide infinite adjustment in a compact package. Item S2-160402 can also be used as a ground connection and features an M10 thread.

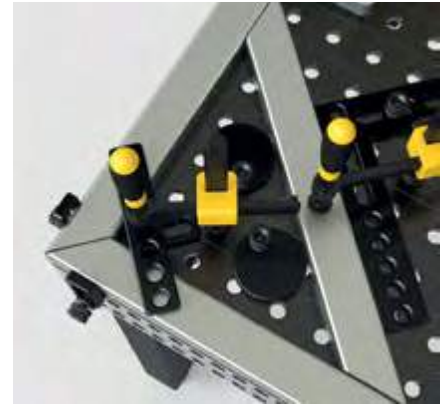

Item Number	Name	Dia. (mm)	Thickness (mm)	Weight (kg)
S2-160401	Eccentric Stop Ø 45	45	12	0.13
S2-160402	Eccentric Stop Ø 75 with M10 thread	75	12	0.38



S2-160444



S2-160455

Flat Square provides a quick way to square parts at right angles.

Angle alignment template provides an easy way to set an angle either in set increments of 5 degrees or variable increments from 0 - 90 degrees. Spacer Sleeve included.

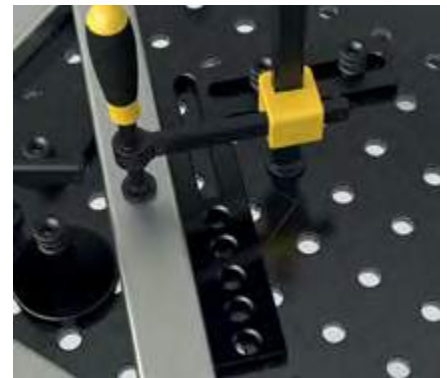

Item Number	Name	Length (mm)	Width (mm)	Thickness (mm)	Adj. Range (mm)	Weight (kg)
S2-160444	Flat Square	250	188	50	12	1.35
S2-160455	Angle Alignment Template - Spacer Sleeve	130	130	5	--	0.40





S2-160105



S2-160108-N



S2-160109



S2-160110-N



S2-160111



S2-160113

Stop and Clamping Squares can be used in the same manner as a stop or combined with other elements to form more complex fixtures. Oblong slots enable a range of adjustable options.

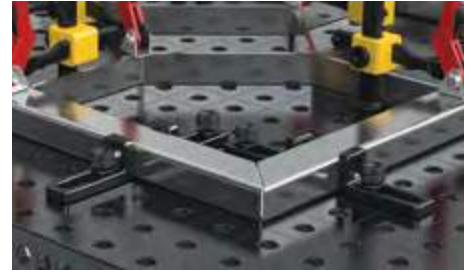

Item Number	Name	Length (mm)	Width (mm)	Height (mm)	Thickness (mm)	Weight (kg)
S2-160105	Stop and Clamping Square 50 L	50	30	50	12	0.20
S2-160108-N	Stop and Clamping Square 90 X	90	30	25	12	0.19
S2-160109	Stop and Clamping Square 90 SL with fine scaling on both sides	90	30	40	12	0.21
S2-160110-N	Stop and Clamping Square 90 L - Nitrided with fine scaling on both sides	90	30	90	12	0.31
S2-160111	Stop and Clamping Square 90 WL with fine scaling on both sides	90	30	90	12	0.27
S2-160113	Stop and Clamping Square 90 VL with fine scaling on both sides	90	30	90	12	0.34



S2-160112



S2-160114



S2-160162



S2-160164



Item Number	Name	Length (mm)	Width (mm)	Height (mm)	Thickness (mm)	Weight (kg)
S2-160112	Stop and Clamping Square 140 L with fine scaling on both sides	90	35	140	12	0.51
S2-160114	Stop and Clamping Square 150 L	90	35	150	12	0.65
S2-160162	Stop and Clamping Square 300 G - stop on left	150	50	300	12	2.40
S2-160164	Stop and Clamping Square 500 G - stop on left	150	50	500	12	4.40

3D Stop and Clamping Squares are manufactured from high quality ductile cast iron and specifically designed to handle heavy parts.

They serve equally well for stopping large parts, serving as table extensions, or building vertically. Cut outs are optimized for lighter weight and easier handling, while the hardening process makes them even stronger and more durable. New clamping squares with rotation slots provide more ways to create angled fixtures. Squares come in two versions with stops on either the left or right side.



Item Number	Name	Length (mm)	Width (mm)	Height (mm)	Weight (kg)
S2-160161 S2-160163	Stop and Clamping Square 250 G with rotation angle - stop on left / right	145	50	250	2.16
S2-160124 S2-160126	Stop and Clamping Square 250 GK - stop on left / right - standard with fine scale	145	50	250	2.10



Item Number	Name	Length (mm)	Width (mm)	Height (mm)	Weight (kg)
S2-160134 S2-160136	Stop and Clamping Square 500 GK - stop on left / right - standard with fine scale	195	50	500	5.30
S2-160146-P S2-160148-P	Stop and Clamping Square 750 GK Plasma nitrided - stop on left / right - standard with fine scale	200	100	750	8.30





S2-160190



S2-160171

The corner square is used to mount clamping squares or U-shapes at table corners to extend the work surface.

Load-Bearing Adjustable Angle Protractor is weight bearing due to a hydro mechanical mechanism and has a built in angle guide.

Item Number	Name	Length (mm)	Width (mm)	Height (mm)	Weight (kg)
S2-160190	Corner Connection, Cast Iron	100	65	100	1.7
S2-160171	Universal Angle Hydromechanical Clamping	250	-	-	2.8



S2-160300



S2-160301

The support and clamping frame serves as a connection for different elements. Bore holes with slots provide numerous fixture possibilities.

Item Number	Name	Length (mm)	Width (mm)	Height (mm)	Weight (kg)
S2-160300	Support and Clamping Frame, small - stop on right	100	50	150	2.1
S2-160301	Support and Clamping Frame, small - stop on left	100	50	150	2.1



S2-160280-P



S2-160290-P

Clamping blocks can be used to join two tables together or as vertical extensions. Clamping blocks should be joined with Connecting Bolts (S2-160560).

Item Number	Name	Length (mm)	Width (mm)	Height (mm)	Thickness (mm)	Weight (kg)
S2-160280-P	Clamping Block - five-sided - Plasma nitrided	300	300	100	12	approx. 16
S2-160290-P	Clamping Block - five-sided - Plasma nitrided	500	500	100	12	approx. 40



Riser blocks are used as table extensions and vertical setups, they are available in 100 x 100 mm and 200 x 100 mm profiles.

Riser blocks are plasma nitride hardened. Riser blocks over 500 mm in length come with leg mounting holes; all lengths longer than 500 mm should be supported by additional legs when used in a cantilever position.

**SAFETY NOTE:** Riser Blocks should only be joined to the table using connector bolts (Item S2-160560 or S2-2160550-1). Do not use fast clamping bolts or other available bolts to join.

Visit our website for more information on riser blocks.



Item Number	Name	Length (mm)	Width (mm)	Height (mm)	Weight (kg)
S2-160396-P	Riser Block 100 x 100 x 100 Plasma nitrided	100	100	100	approx. 3
S2-160360-P	Riser Block 500 x 100 x 100 Plasma nitrided	500	100	100	approx. 13
S2-160370-P	Riser Block 1,000 x 100 x 100 Plasma nitrided	1,000	100	100	approx. 25



Item Number	Name	Length (mm)	Width (mm)	Height (mm)	Weight (kg)
S2-160396-1-P	Riser Block 100 x 200 x 100 Plasma nitrided	100	200	100	approx. 6
S2-160360-1-P	Riser Block 500 x 200 x 100 Plasma nitrided	500	200	100	approx. 17
S2-160370-1-P	Riser Block 1,000 x 200 x 100 Plasma nitrided	1,000	200	100	approx. 35
S2-160380-1-P	Riser Block 1,500 x 200 x 100 Plasma nitrided	1,500	200	100	approx. 50
S2-160390-1-P	Riser Block 2,000 x 200 x 100 Plasma nitrided	2,000	200	100	approx. 66

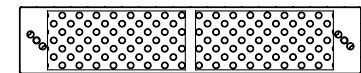
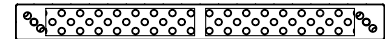

Lightning-fast and optimized

**DUE TO ITS WELL-ENGINEERED MECHANISM**

**IT CAN BE CLAMPED AND RELEASED BY HAND WITHIN SECONDS.**

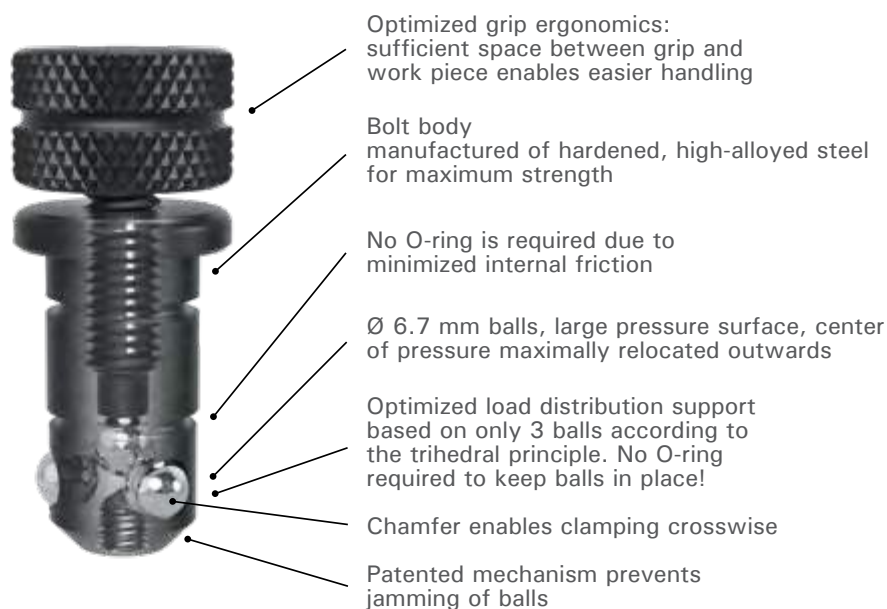

#### TIGHTENING TORQUE (AM)

The tightening torque is the force required to fasten the bolt using a torque wrench. In order to achieve maximum clamping force, the tightening torque should not exceed the recommended guideline.

The bolt was designed to only require a low torque to reach maximum clamping force, thereby enabling simple manual clamping.

Max. AM of S2-160510:  $\leq 10 \text{ Nm}$



#### SHEARING FORCE (SK)

The shearing force is the force which reacts laterally to the cross-sectional area of the bolt.

Max. SK of S2-160510:  $\leq 55 \text{ kN}$

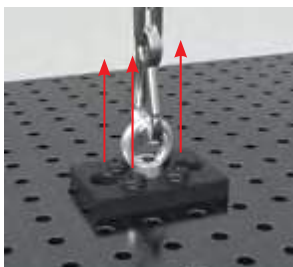

#### TENSILE FORCE (ZK)

The tensile force is the force created when pulling on fixed bolts.

Max. ZK of S2-160510  $\leq 10 \text{ kN}$

All bolts come in short and long versions. Short bolts are designed for connecting two Siegmund components together such as a table to a stop or a stop to a square. Long bolts are designed for connecting three Siegmund components together. Connecting Bolts are used to join heavy parts such as riser blocks to tables.



S2-160510 S2-160512

**Fast clamping Bolts** - Standard bolts used for the majority of applications.



S2-160522 S2-160523

**Low Profile Bolts** - Low profile bolt for use in slotted applications where a flush mount is not appropriate.



S2-160528 S2-160529

**Flush Mount / Flat Bolts** - Used to connect bolt components without the bolt head interfering with the work piece.



S2-160532 S2-160533

**Universal Clamping Bolt** - Use the Universal Clamping Bolts to connect accessories of different material thicknesses.

**NOT to be used for joining tables & U-shaped squares.**



S2-160560 S2-160561

**\* Connecting Bolts** - The only bolt permitted for use to form connections with heavy parts such as Riser Blocks to tables.



S2-160540

Quick positioning bolt for applications where clamping force is not required.

Item Number	Name	Length (mm)	Dia. (mm)	Shearing Force (kN)	Tightening Torque (Nm)	Tensile Force (kN)	Note	Weight (kg)
S2-160510	Fast Clamping Bolt short	--	16	55	10	10	For clamping 2 components with screw top	0.08
S2-160512	Fast Clamping Bolt long	--	16	55	10	10	For clamping 3 components with screw top	0.10
S2-160522	Fast Clamping Bolt, flat short	36	16	55	10	10	For clamping 2 components	0.05
S2-160523	Fast Clamping Bolt, flat long	48	16	55	10	10	For clamping 3 components	0.08
S2-160528	Flush Mount Bolt short	31	16	55	10	3	For clamping 2 components	0.04
S2-160529	Flush Mount Bolt long	43	16	55	10	3	For clamping 3 components	0.05
S2-160532	Universal Bolt short	--	16	50	10	10	For clamping 2 components 22-28 mm clamping range	0.11
S2-160533	Universal Bolt long	--	16	50	10	10	For clamping 3 components 34-40 mm clamping range	0.12
S2-160560	Connecting Bolt short	--	16	50	15	4	For connecting 2 components - with Allen key	0.03
S2-160561	Connecting Bolt long	--	16	50	15	4	For connecting 3 components - with Allen key	0.05
S2-160540	Positioning Bolt	--	16	--	--	--	--	0.07

All System 16 Prisms are equipped with a removable screwed-in collar. Included in delivery of each Prism is a screwed-in collar and a countersunk bolt.



WITH COLLAR IN BORE HOLE

The prism with collar is universally applicable for all system 16 boreholes, and offers a sturdy support surface for pipes.



WITHOUT COLLAR ON TABLE

All System 16 Prisms can be used without collar. Consequently they can be positioned on the table independently from the hole grid.



S2-160645-1

Vario Prism Ø 50 is suitable for both rounded and 45 degree twisted square pipes up to 80 mm in diameter due to its 90 and 120 degree angles.

Can be used with collar for bore holes or free of the hole grid by unfastening the collar.

Polyamid versions also available for scratch sensitive surfaces.



S2-160652-1

Prism Ø 80 120° is suitable for pipes with a diameter up to 120 mm. Can be used with collar for bore holes or free of the hole grid by unfastening the collar.

Polyamid versions also available for scratch sensitive surfaces.



S2-160670

The Clamping cone enables clamping of round and square pipes with a diameter of up to 45 mm. Cone enables locating through the centerline of tubes. Clamping cone is fastened using bolts such as S2-280510 and contains no collar.

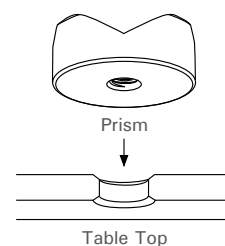

Special screw - S2-160649-0

OR ALTERNATIVELY:

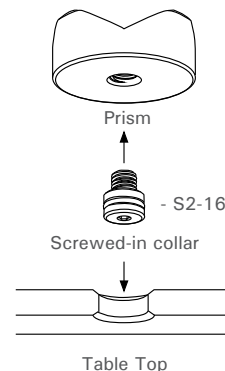

Item Number	Name	Height (mm)	Dia. (mm)	Weight (kg)
S2-160645-1	Vario Prism Ø 50 90° / 120° with screwed-in collar (M10 Thread) - Burnished	20	50	0.21
S2-160652-1	Prism Ø 80 120° with screwed-in collar (M10 Thread) - Burnished	30	80	0.77
S2-160670	Clamping Cone - Burnished	40	45	0.26



## PRISM EXTENSIONS



S2-160822

Screw Support, especially intended for vernier adjustments ranging from 50 - 70 mm. Height compensation can be substantially increased by using prism extensions and the set of supports.



S2-160821

7-piece Set of Supports, offers the option to create height-adjustable work surfaces. The individual supports can be utilized to compensate for height differences of 1 - 60 mm. In order to achieve the intended height precisely, the lowest grading of the Supports is 1 mm. The measurements are specified on the particular discs.



S2-160649

S2-160649-0

S2-160649-1

S2-160649-2

The Prism extension can be quickly and securely screwed in all prisms and enables positioning of the prism at different heights in combination with spacers (Item No. S2-280821). With the screw support (Item No. S2-280822) an infinitely variable positioning is possible.

S2-160649 is a collar which inserts into the system holes.

S2-160649-0 has a flush mount protrusion to securely mount into system holes.

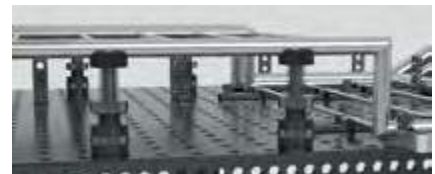

Item Number	Name	Height (mm)	Dia. (mm)	Weight (kg)
S2-160822	Screw Support Ø 50 - Burnished	50 - 70	50	0.71
S2-160821	Set of Supports 7 pieces - Burnished Disc thickness: 1 / 2 / 3 / 5 / 10 / 20 mm	65	25	0.17
S2-160649	Prism Screw-in Collar - Burnished	19	16	0.02
S2-160649-0	Special screw - for prisms system 16	20	16	0.02
S2-160649-1	Prism Extension 50 - Burnished	50	16	0.08
S2-160649-2	Prism Extension 100 - Burnished	100	16	0.15



S2-160610

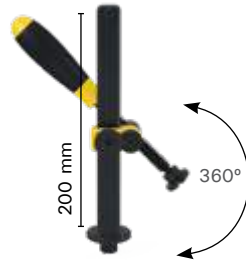

S2-160630

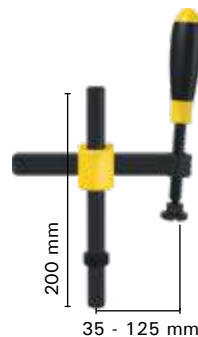

S2-160601

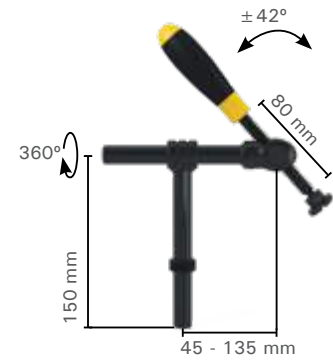

S2-160604

Versatile clamping systems ensure a clamp for your every need. All clamps easily set with one hand and feature interchangeable pads for work with sensitive materials.

The Standard Screw Clamp adjusts by hand along the vertical and horizontal axis for precise placement anywhere on the table.

The Basic Pipe Clamp Universal features horizontal and vertical adjustment as well as pivoting action at the spindle head. An adjustment ring at the base allows it to sit in a lower profile during welding as the round bar sits below the table or clamping square surface.

Spindle and bushings from item S2-160610 can be removed by hand and inserted into system holes for clamping with stops and squares.



Item Number	Name	Maximum Load (kN)	Weight (kg)
S2-160610	Professional Screw Clamp	2.5	1.20
S2-160630	Professional Screw Clamp	2.5	0.75
S2-160601	Screw Clamp with Round Pipe	1.5	1.00
S2-160604	Basic Pipe Clamp Universal	1.5	0.80



PTT11K

PTT14K



S2-160740



S2-160740-1



S2-160539



Table Mount C-Clamp for repetitive clamping. Clamping range can be set with adjusting screw.

Magnetic Clamping Bolt, enables fast clamping without bolting or the use of tools. It is preferable for pressure-sensitive parts like thin sheet metal, as well as enclosed shapes.

Item Number	Name	Height (mm)	Dia. (mm)	Weight (kg)
PTT11K	Table Mount C-Clamp, 100 mm clamping capacity, 85 mm throat depth	--	--	0.41
PTT14K	Table Mount C-Clamp, 120 mm clamping capacity, 155 mm throat depth	--	--	0.73
S2-160740	Magnetic Clamping Bolt 34 - Length of Shaft 12 mm - Aluminum	34	22	0.02
S2-160740-1	Magnetic Clamping Bolt 46 - Length of Shaft 24 mm - Aluminum	46	22	0.03
S2-160539	Spacer Sleeve	12	21	0.02



S2-160910

Tool Cart, offers sufficient space for your Siegmund accessories. Your tools are handy, and you always keep track of them. Large squares are practically and safely stored in the inside space. Due to the casters, the tools are quickly transported to different points of use.



Item Number	Name	Length (mm)	Width (mm)	Height (mm)	Weight (kg)
S2-160910	Tool Cart	560	560	720	30.0



S2-000810

16 mm Ground Connection guarantees 100% contact to the welding table. Install by simply fastening it in a system bore hole.

Fits Cable cross sections 70 - 95 mm<sup>2</sup> (cable not included).

Fits both 28 and 16 mm holes.



Item Number	Name	Load Rating
S2-000810	16 mm Ground Connection	500 Ampere



S2-160830

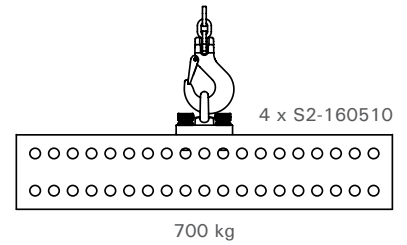

The Shipping Bracket with fastening plate has a load capacity of 700 kg. It is used to move welding tables and other heavy Siegmund elements safely and easily. It is fastened quickly and simply with four clamping bolts.

The general regulations for the use of shipping brackets must be followed. The load capacity can be reduced substantially, depending on operating conditions. During transport, the table may not be raised more than 100 mm, and no one is permitted underneath the table.

In addition, the shipping brackets can be used as an easy fastener for lashing straps.

Please consider following safety instructions: Ring nuts should be completely bolted. Ring nuts should bear flat and completely on support surface.





Length of mating thread has to be sufficient. Lateral pull should be avoided.













Item Number	Name	Length (mm)	Width (mm)	Height (mm)	Weight (mm)
S2-160830	Lifting Bracket with Eye Nut - 700 kg load-bearing capacity (with 4 x S2-160510)	150	100	25	2.63

## FIXTURING KITS

Choose a fixture kit from below or contact us for consultation on a fixture kit to meet your specific needs. All fixture kits come with the accessory pack below for basic maintenance.

Fixture Kit #1	S2-163100	28pcs	Weight: 9 kg / 20 lbs	
				
S2-160610	S2-160510	S2-160420-N	S2-160110-N	S2-160108-N
4 x	12 x	4 x	4 x	4 x

Fixture Kit #2	S2-163200	54pcs	Weight: 21 kg / 47 lbs		
					
S2-160610	S2-160630	S2-160645-1	S2-160510	S2-160410-N	S2-160420-N
6 x	2 x	4 x	18 x	4 x	6 x
					
S2-160110-N	S2-160108-N	S2-160162			
6 x	6 x	2 x			

Fixture Kit #3	S2-163300	72pcs	Weight: 32 kg / 71 lbs		
					
S2-160610	S2-160630	S2-160645-1	S2-160510	S2-160410-N	S2-160420-N
8 x	4 x	4 x	24 x	4 x	8 x
					
S2-160110-N	S2-160108-N	S2-160162			
8 x	8 x	4 x			

## FIXTURING KITS

Fixture Kit #4	S2-163400	97pcs	Weight: 83 kg / 183 lbs			
						
S2-160610	S2-160630	S2-160645-1	S2-160510	S2-160410-N	S2-160420-N	S2-160110-N
10 x	4 x	8 x	30 x	8 x	10 x	10 x
						
S2-160108-N	S2-160162	S2-160161 + S2-160163	S2-160134 + S2-160136	S2-160910		
8 x	4 x	1 x + 1 x	1 x + 1 x	1 x		

Fixture Kit #5	S2-163500	117pcs	Weight: 105 kg / 232 lbs			
						
S2-160610	S2-160630	S2-160645-1	S2-160510	S2-160410-N	S2-160420-N	S2-160110-N
12 x	6 x	8 x	36 x	8 x	12 x	12 x
						
S2-160108-N	S2-160162	S2-160161 + S2-160163	S2-160134 + 2-160136	S2-160146-P + S2-160148-P	S2-160910	
12 x	4 x	1 x + 1 x	1 x + 1 x	1 x + 1 x	1 x	

Accessory pack S2-163999 comes with each Siegmund fixture kit.

				
S2-160402	S2-160852	S2-160820	S2-000942	S2-160920



**Customer Service**

Toll Free: 800.989.5244  
Tel: + 1.562.949.8625  
E-mail: [sales@stronghandtools.com](mailto:sales@stronghandtools.com)

**Address**

8750 Pioneer Blvd.,  
Santa Fe Springs, CA 90670  
U.S.A.

© Copyright 2018.  
All Rights Reserved.

[www.StrongHandTools.com](http://www.StrongHandTools.com)